



NAN HUA PRIMARY SCHOOL
PRELIMINARY ASSESSMENT 2024
PRIMARY 6

SCIENCE

BOOKLET A

28 Multiple Choice Questions (56 marks)

Total Time for Booklets A and B: 1 hour 45 minutes

INSTRUCTIONS TO CANDIDATES

1. Write your name, index number and class in the spaces provided below.
2. Do not turn over this page until you are told to do so.
3. Follow all instructions carefully.
4. Answer all questions.
5. Use a 2B pencil to shade your answers on the Optical Answer Sheet (OAS).

Marks Obtained

Booklet A		/ 56
Booklet B		44
Total		/ 100

Name: _____

Form Class P6 _____

Teaching Group 6S _____

Date: 20 August 2024

Parent's Signature: _____

This booklet consists of 20 printed pages.

Section A: (28 x 2 marks = 56 marks)

For each question from 1 to 28, four options are given. One of them is the correct answer. Make your choice (1, 2, 3 or 4) and shade your answer on the Optical Answer Sheet.

1 Study the diagrams carefully.

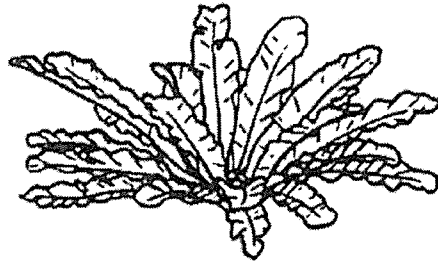

living thing A



living thing B

Which of the following are characteristics of both living things A and B?

- (1) make its own food and grow
- (2) grow and respond to changes
- (3) need water and depends on others for food
- (4) move from one place to another and make its own food

2 Study the chart on classification of organisms.

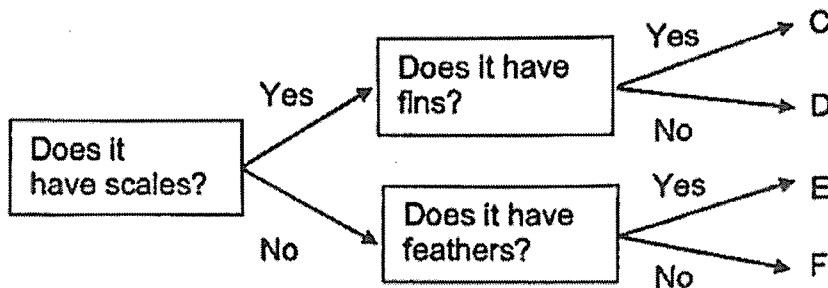

Which of the following is correct?

	Reptile	Fish	Mammal	Bird
(1)	C	D	E	F
(2)	C	F	D	E
(3)	D	C	F	E
(4)	D	C	E	F

0009/02(A)

3

3 Which of the following is correct for both the butterfly and beetle?

- (1) The larvae of both insects feed a lot.
- (2) The young and the adult of both insects moult.
- (3) Both insects have young that look like the adults ✓
- (4) Both insects have three stages in their life cycles.

4 The diagram shows organism X which is made up of one cell.

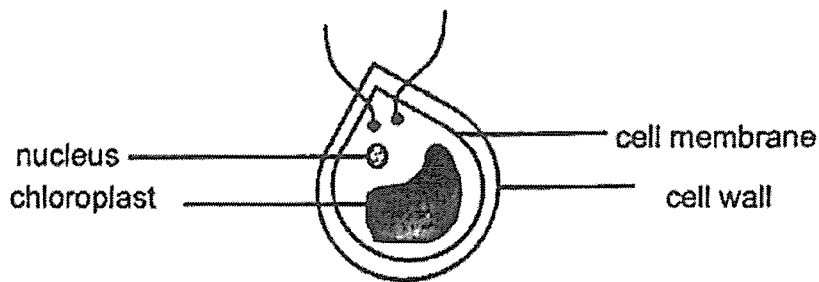

Four students made the following statements:

- Peter: Organism X can make its own food.
- Samuel: Organism X is an animal cell because it has cell membrane.
- Ruby: Organism X has a nucleus that controls all activities taking place in the cell.
- Quin: Organism X has a cell wall that allows certain substances to move in and out of the cell.

Who is/are correct?

- (1) Peter only
- (2) Samuel only
- (3) Peter and Ruby only
- (4) Peter, Ruby and Quin only

(Go on to the next page)

0009/02(A)

5 Study the distribution of plants P, Q and R.

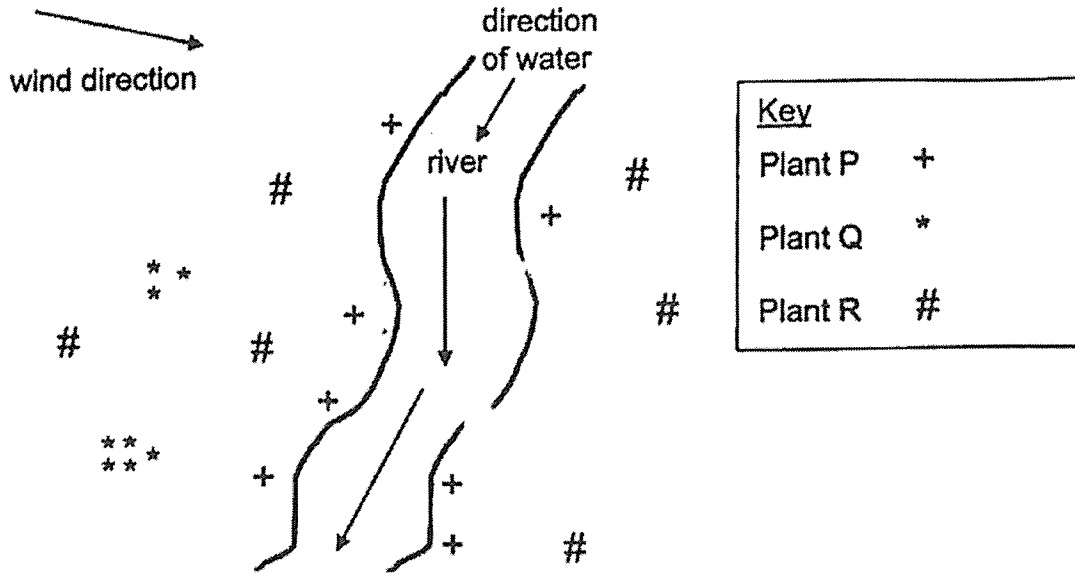

Which of the following correctly identifies the fruits of plants P, Q and R?

	Plant P	Plant Q	Plant R
(1)	hook	hair-like structure	seed pod
(2)	seed pod	fibrous husk	hair-like structure
(3)	fibrous husk	seed pod	hook
(4)	fibrous husk	hook	seed pod

6 The diagram below shows a flower from plant J.

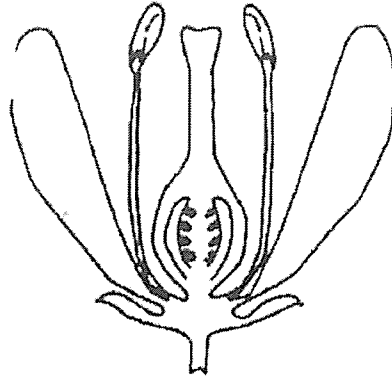

Ali conducts an experiment using three flowers from plant J. He removed some parts from each of the flowers as shown below.

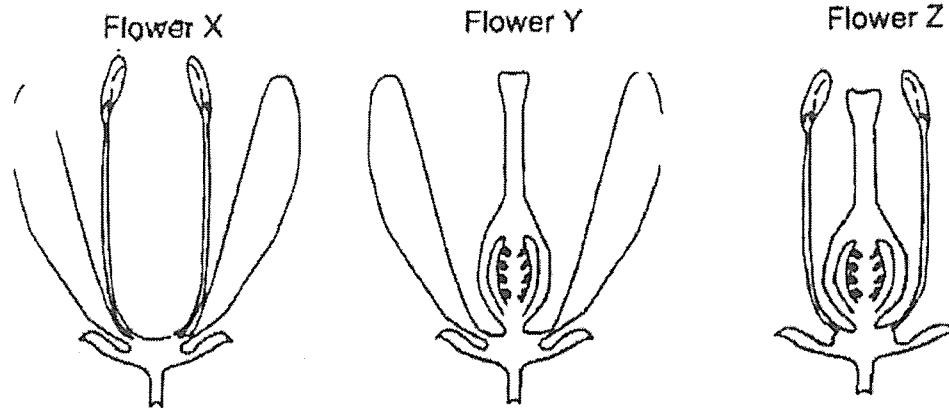

Which flower(s) can still develop into a fruit?

- (1) Y only
- (2) Z only
- (3) X and Y only
- (4) Y and Z only

(Go on to the next page)

0009/02(A)

7 The diagram shows the human digestive system.

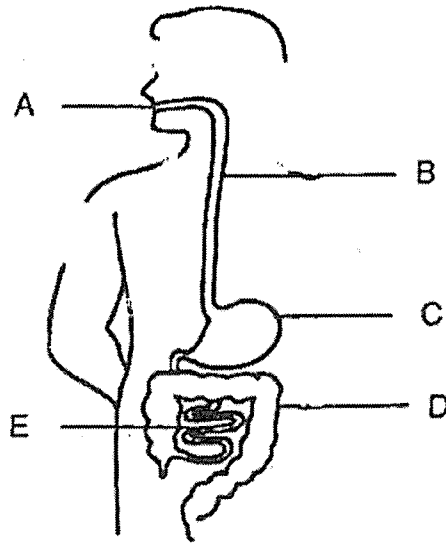

Which of the following about the parts labelled A, B, C, D and E is correct?

	Absorb(s) digested food Into the body	Remove(s) water from undigested food
(1)	B, E	A, D
(2)	D, E	B, C
(3)	D	E
(4)	E	D

8 Bird Z uses its feet to grab and hold on to its prey. Which of the following correctly shows the foot of bird Z?

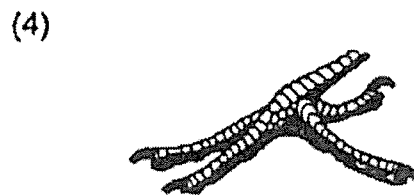
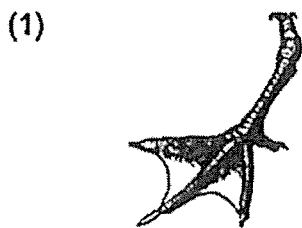

0009/02(A)

- 9 The diagram shows how water and substance P flow through tubes to different parts R, S and T of a plant.

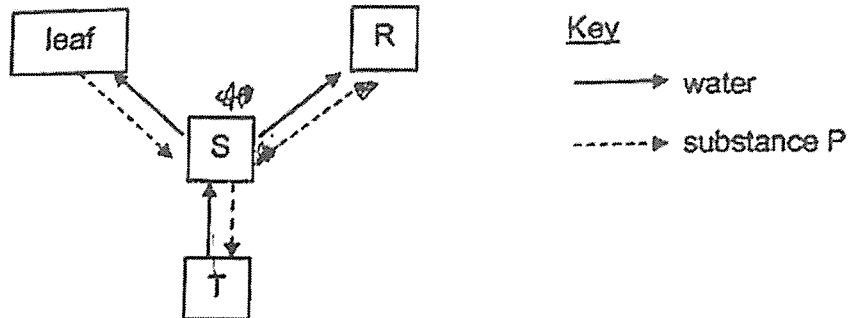

Which of the following correctly identifies parts R, S, T and substance P?

	Part R	Part S	Part T	Substance P
(1)	flower	stem	root	sugars
(2)	flower	root	stem	mineral salts
(3)	root	stem	fruit	carbon dioxide
(4)	stem	flower	root	sugars

- 10 The food relationship between three organisms is shown.

Grain → Rat → Snake

Based on the food relationship in the above food chain, which terms describe the rat?

- (1) producer and prey
- (2) prey and predator
- (3) consumer and prey
- (4) consumer and decomposer

(Go on to the next page)

11 Two boys were trapped in a lift for several hours.

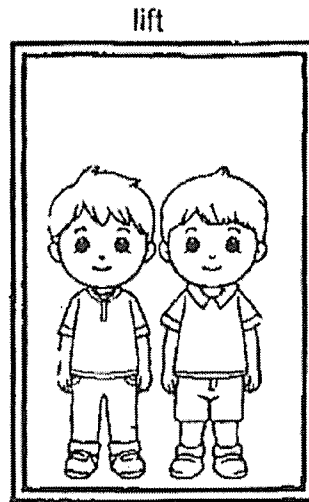

Which graph shows the amount of oxygen, water vapour and carbon dioxide in the lift as time goes by?

Key

- : oxygen
- : water vapor
- - - : carbon dioxide

(1)

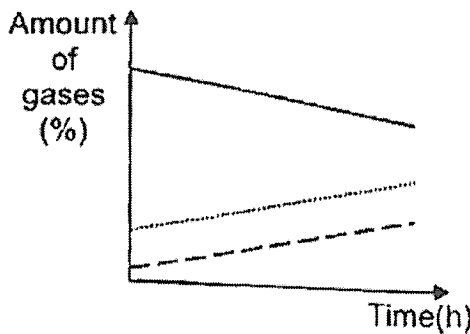

(2)

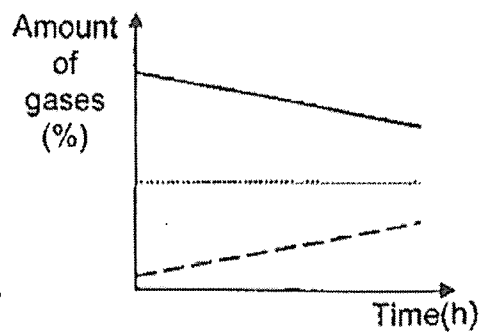

(3)

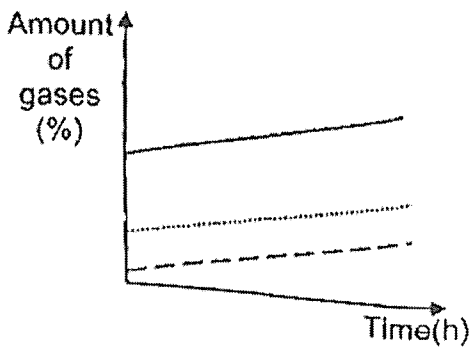

(4)

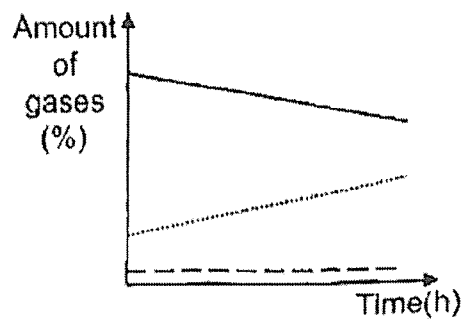

0009/02(A)

12 The key below shows substances flowing in the human systems.

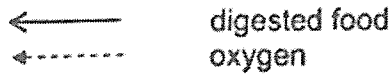

Which of the following shows how substances flow in the different human systems correctly?

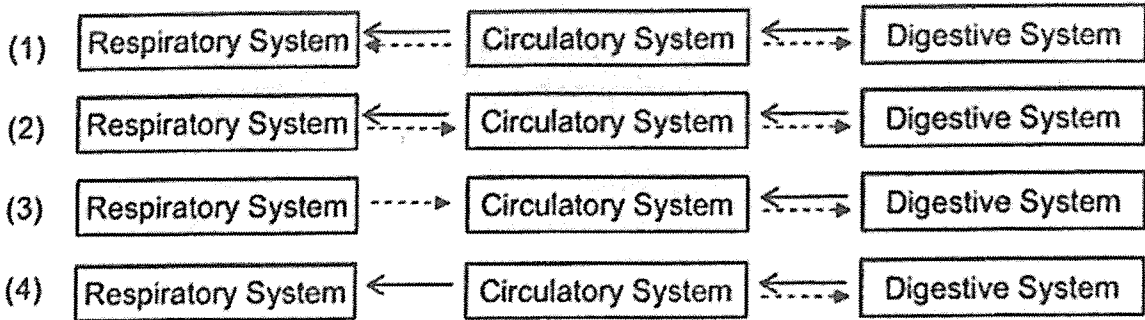

13 Paul placed twenty organism S in the centre of the container at the beginning of an experiment.

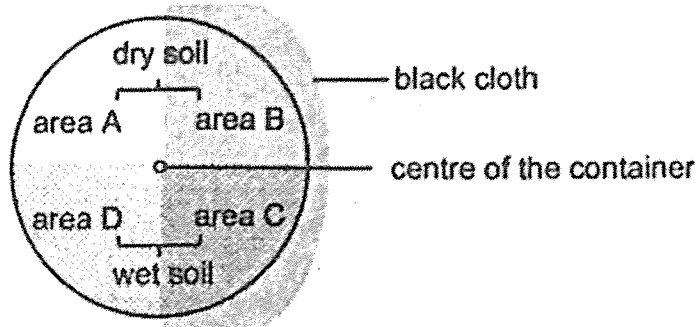

After an hour, he counted and recorded the number of organism S in each area as shown in the table below.

Area	Number of organism S
A	0
B	0
C	18
D	2

Which habitat can organism S be found?

- (1) pond
- (2) desert
- (3) garden
- (4) leaf litter

14 Deforestation by burning and cutting down trees affect the environment.



What are the environmental effects when the forest is cleared as shown above?

- A Less oxygen is released into the air.
 - B There is an increase risk for landslides.
 - C The temperature of the surrounding will decrease
 - D There is an increase in the level of carbon dioxide in the air.
-
- (1) A and C only
 - (2) B and D only
 - (3) A, B and C only
 - (4) A, B and D only

15 Study the diagram below.

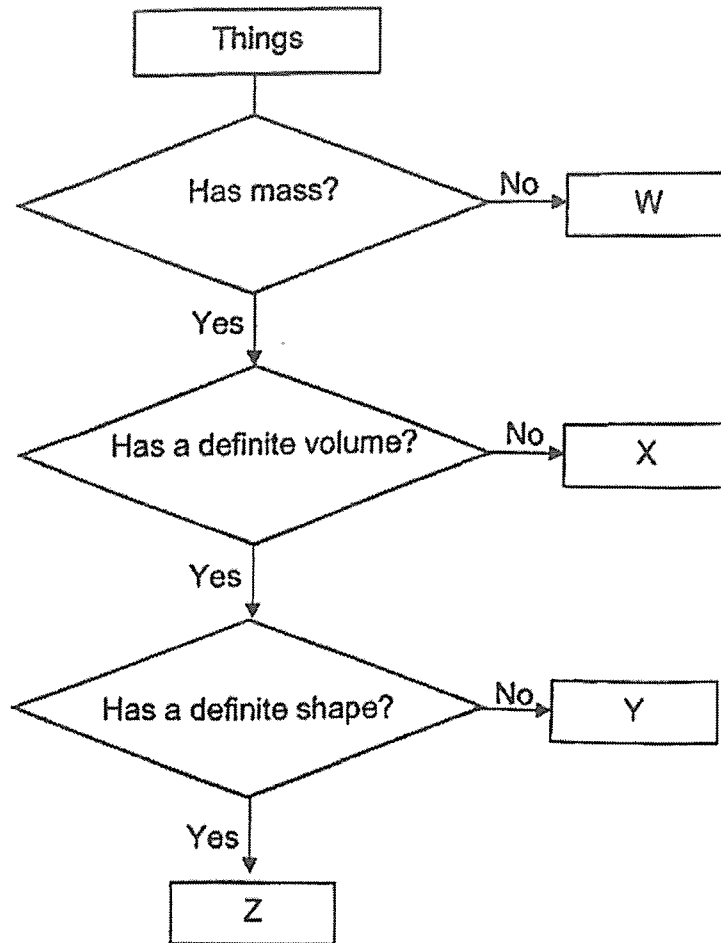

What could W, X, Y, and Z be?

		X	Y	Z
(1)	heat	sand	water vapour	oxygen
(2)	light	water vapour	sand	oil
(3)	oxygen	oil	sand	sound
(4)	sound	oxygen	oil	sand

(Go on to the next page)

0009/02(A)

16 Cindy finds that she is still able to pump in air into a fully inflated basketball. Which of the following statements explains her observation?

- (1) Air has mass.
- (2) Air occupies space.
- (3) Air does not have a definite shape.
- (4) Air does not have a definite volume.

17 The graph below shows the melting point and boiling point of substance Q.

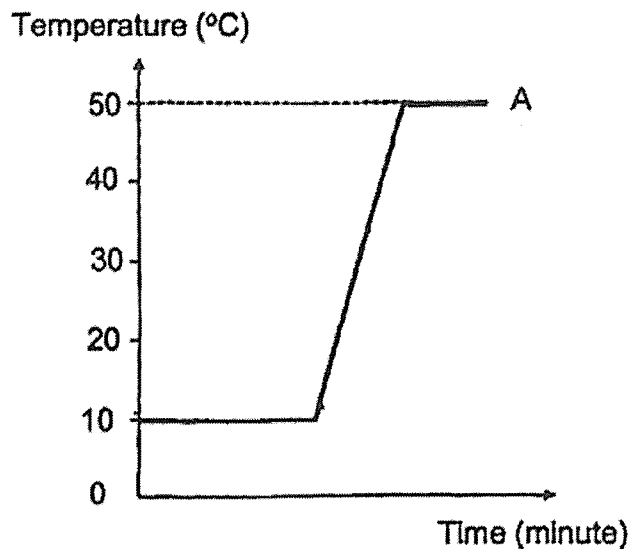

Which one of the following statements about the graph above is **not** correct?

- (1) Substance Q is a solid at 5°C .
- (2) Substance Q is a liquid at 30°C .
- (3) The melting point of substance Q is 0°C .
- (4) The boiling point of substance Q is 50°C .

18 A circuit is set up as shown.

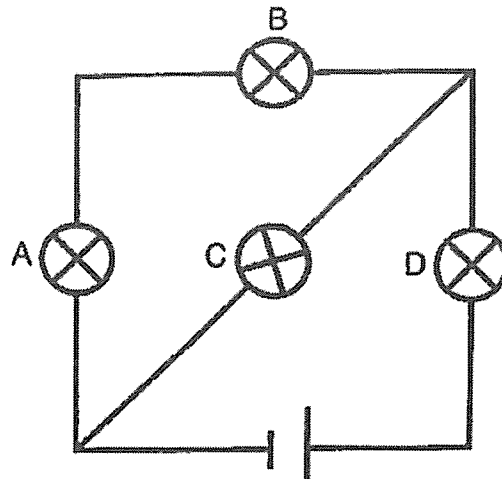

After one of the bulbs had fused, all the other bulbs can still light up. Which bulb had fused?

- (1) A
- (2) B
- (3) C
- (4) D

19 Roy folded a piece of material to make a sailboat. It floated on water for a while before sinking.

What are the properties of the material?

	Property /	
	flexible	waterproof
(1)		
(2)		x
(3)	x	x
(4)	x	

Key
✓ : yes
x : no

(Go on to the next page)

20 Alex stood at the same position and shone the torch on the moving ball as it moved from position X to position Z as shown below.

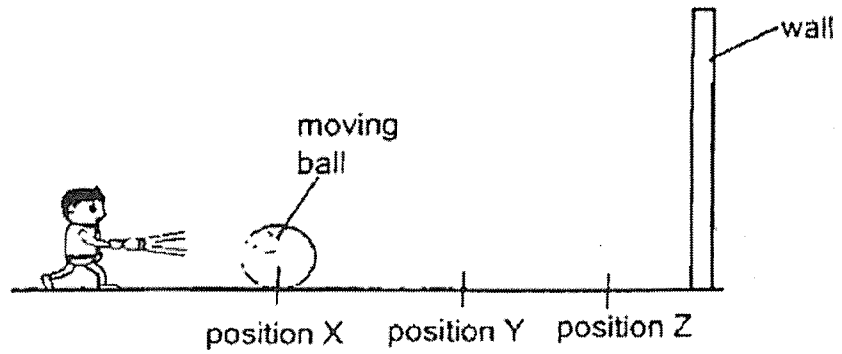

Which graph shows the correct sizes of the shadows when the ball was at various positions?

(1) size of shadow

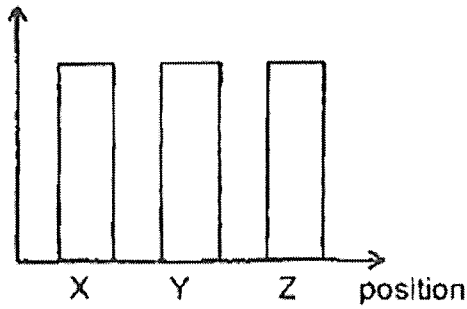

(2) size of shadow

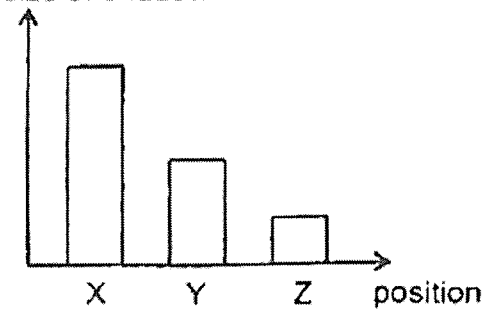

(3) size of shadow

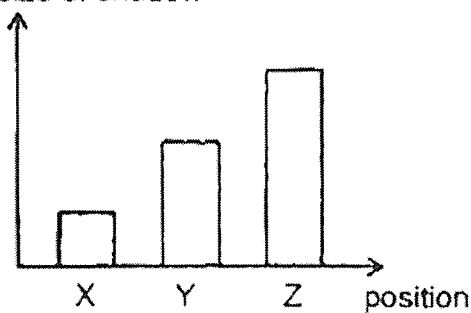

(4) size of shadow

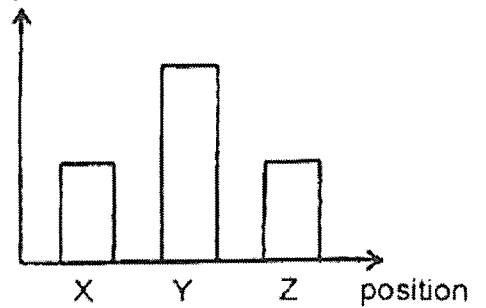

21 Alice observes a butterfly through a magnifying glass.

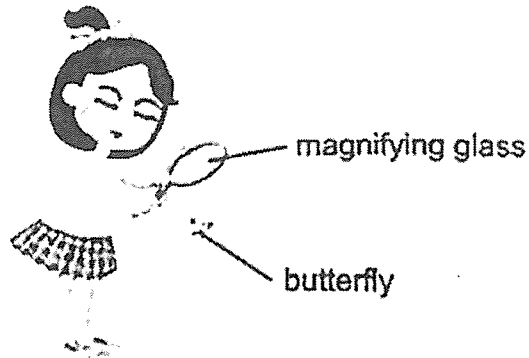

Which statement explains why she can see the magnifying glass?

- (1) Light is reflected from the butterfly.
- (2) No light passes through the butterfly.
- (3) Light passes through the glass easily.
- (4) Some light is reflected from the glass.

22 In the diagram below, when object Y was slowly brought close to object Z, the rubber ball was hit by object Z and pushed off the wooden table.

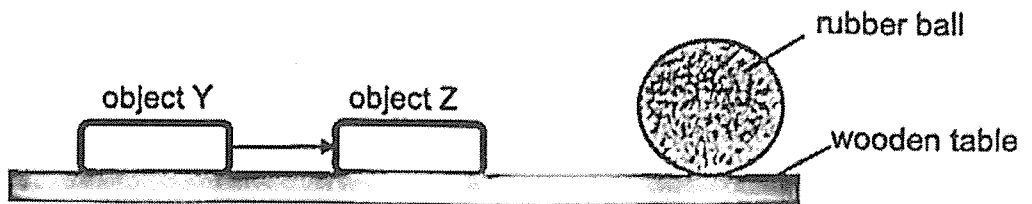

What are objects Y and Z likely to be?

	Object Y	Object Z
(1)	magnet	iron rod
(2)	magnet	magnet
(3)	steel rod	magnet
(4)	iron rod	steel rod

(Go on to the next page)

0009/02(A)

23 Amy had a metal ring which is stuck around the metal rod as shown below.

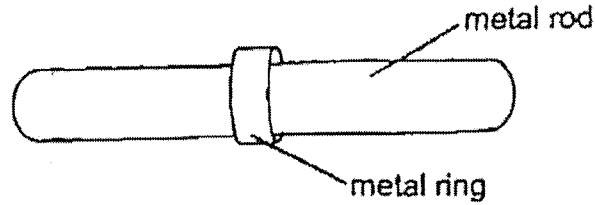

Which of the following methods should Amy use to help her remove the metal ring from the metal rod most effectively?

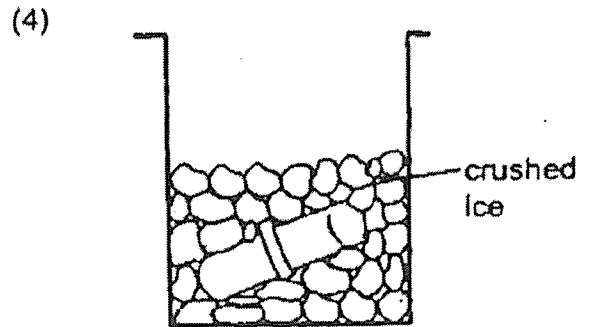
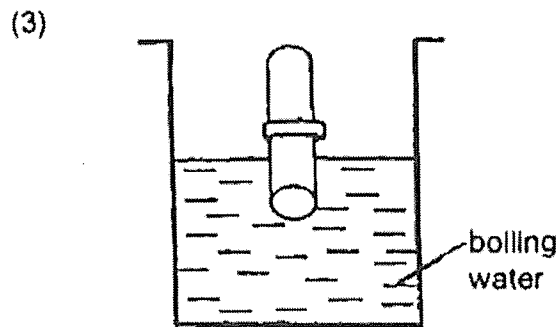
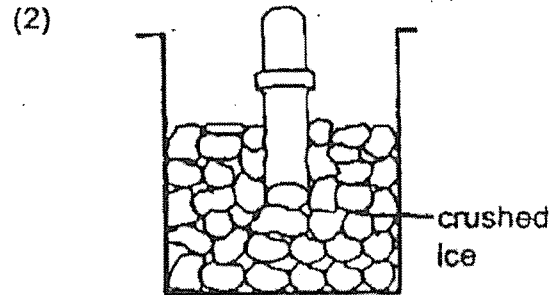
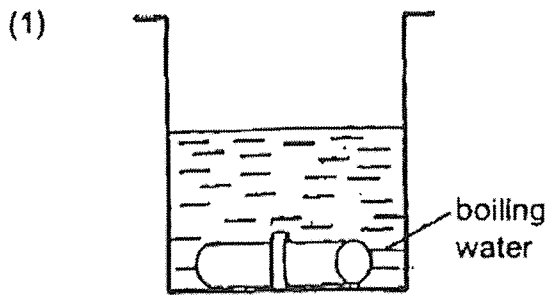

24 Betty prepared two beakers, X and Y, as shown below.

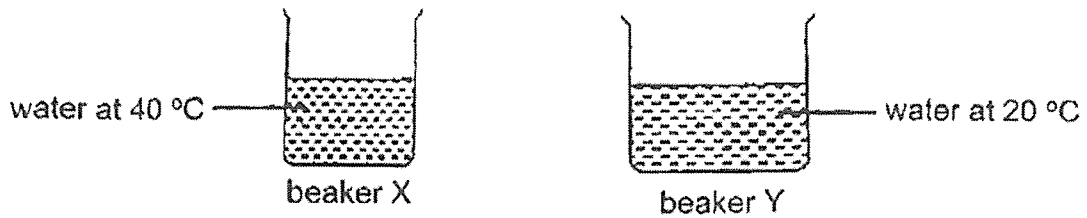

She then placed beaker X into beaker Y and left them in a room with a temperature of 27 °C.

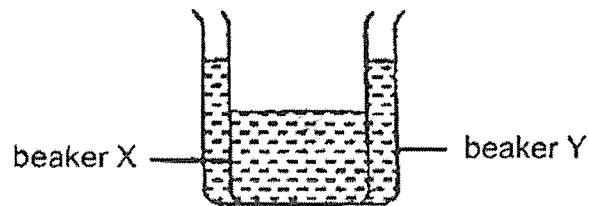

Which of the following shows the possible temperature of the water in the beakers after 30 seconds and the correct explanation for it?

	Beaker X	Beaker Y	Explanation
(1)	29 °C	20 °C	The water in beaker X lost heat to the surrounding air.
(2)	40 °C	30 °C	The water in beaker Y gained heat from the water in beaker X.
(3)	27 °C	27 °C	The water in both beakers lost heat to the surrounding air and reached room temperature.
(4)	35 °C	26 °C	The water in beaker X lost heat to the water in beaker Y.

(Go on to the next page)

25 The diagram below shows the pathway of a ball from point D to point E.

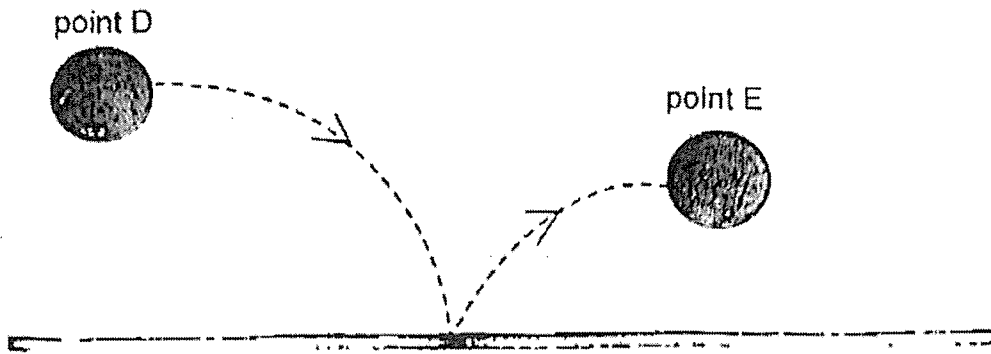

Which of the following graphs correctly shows the change in the amount of kinetic energy (KE) and gravitational potential energy (GPE) of the ball as it moves from point D to point E?

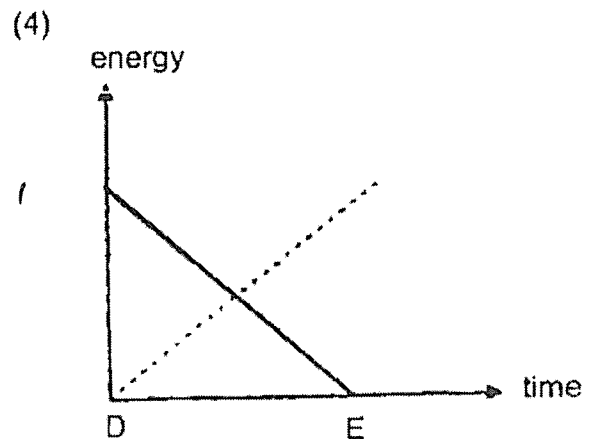
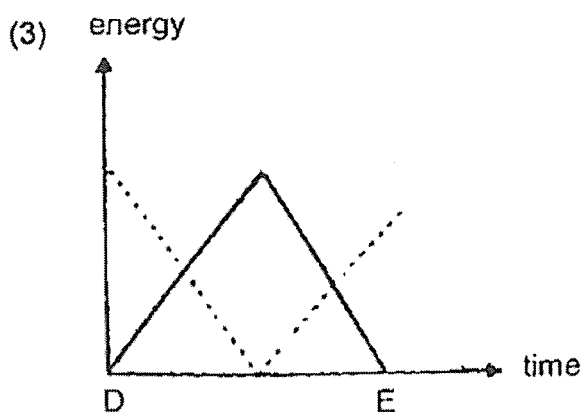
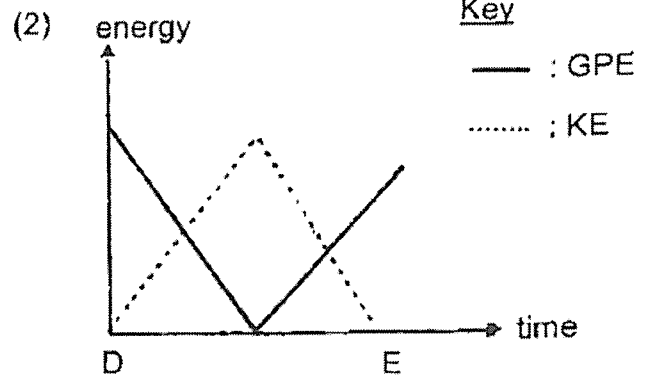
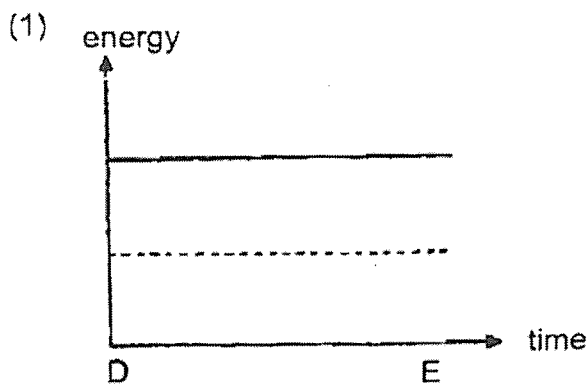

- 26 Ahmad set up three magnets LM, PQ and ST, and an iron bar AB as shown in the arrangement below.

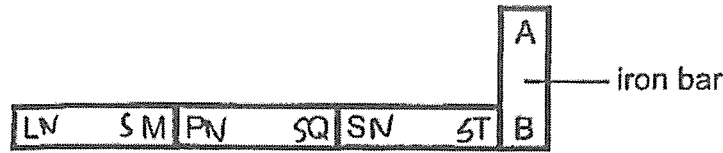

Which of the following arrangements is possible?

(1)

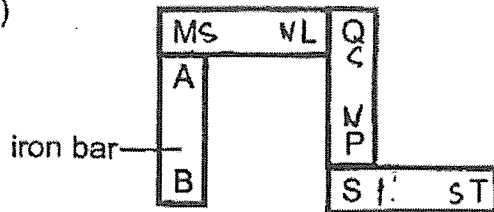

(2)

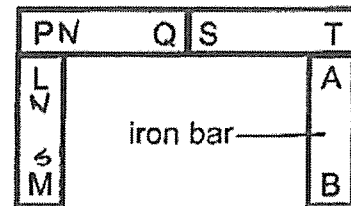

(3)

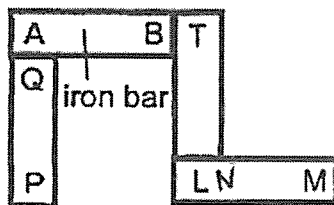

(4)

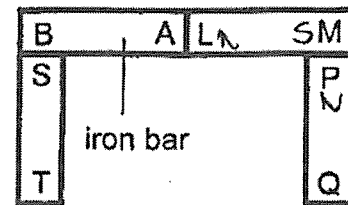

- 27 There are four balls, A, B, C and D, of different masses. Each ball is rolled down from a slope at the same position as shown below. The ball will hit and move the plastic block.



The distance moved by the plastic block when it is hit is recorded in the table below.

Ball	A	B	C	D
Distance moved by the plastic block when it is hit (cm)	25	56	12	37

Which of the following balls, A, B, C or D, has hit the plastic block with the greatest force?

- (1) A
 (2) B
 (3) C
 (4) D

- 28 When Peter put a toy car on a slanted surface, X, the toy slid down. When he put the same toy car on another slanted surface, Y, made of a different material, the toy car did not slide down.

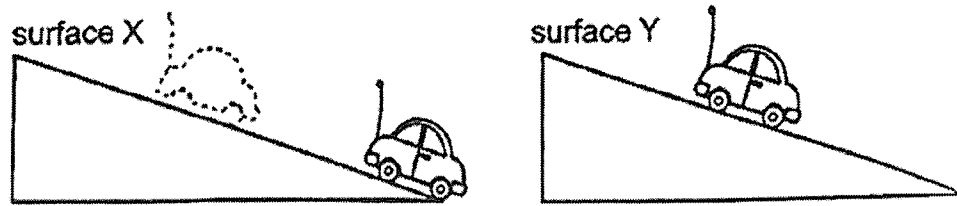

What can you infer from the information given above?

- A Surface X is rougher than surface Y.
 - B There is no gravitational force acting on the toy car when it is placed on surface Y
 - C There is greater frictional force when the toy car is placed on surface Y than on surface X.
 - D There is greater gravitational force acting on the toy car when it is placed on surface X than on surface Y.
- (1) A only
(2) B only
(3) C only
(4) C and D only

(Go on to Booklet B)

0009/02(A)



NAN HUA PRIMARY SCHOOL
PRELIMINARY EXAMINATION 2024
PRIMARY 6
SCIENCE
(BOOKLET B)

Total Time for Booklets A and B: 1 hour 45 minutes

INSTRUCTIONS TO CANDIDATES

1. Write your name, index number and class in the spaces provided below.
2. Do not turn over the page until you are told to do so.
3. Follow all instructions carefully.
4. Answer all questions.
5. Use a dark blue or black ballpoint pen to write your answers in the space provided for each question.
6. Do not use correction fluid/tape or highlighters.

Marks Obtained

Section B		/ 44
-----------	--	------

Name: _____ ()

Class: P 6 _____

Teaching Group: 6S _____

Date: 20 August 2024

Parent's Signature: _____

This booklet consists of 17 printed pages and 1 blank page.

For questions 29 to 40, write your answers in the spaces provided.
The number of marks available is shown in brackets [] at the end of each question or part question. (44 marks)

29. The diagram shows the human reproduction process.

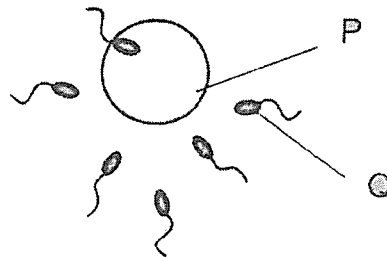

(a) What are cells P and Q? [1]

Cell P: _____

Cell Q: _____

(b) Name the part in cells P and Q that contains information to pass to the young. [1]

(c) Name and describe the human reproduction process as shown in the diagram above. [1]

Score	3
-------	---

0009/02(B)

30 Insect M lays eggs in the flower of plant Y thereby pollinating it. The eggs of insect M hatch in the developing fruit and its young feeds on the flesh of the fruit.

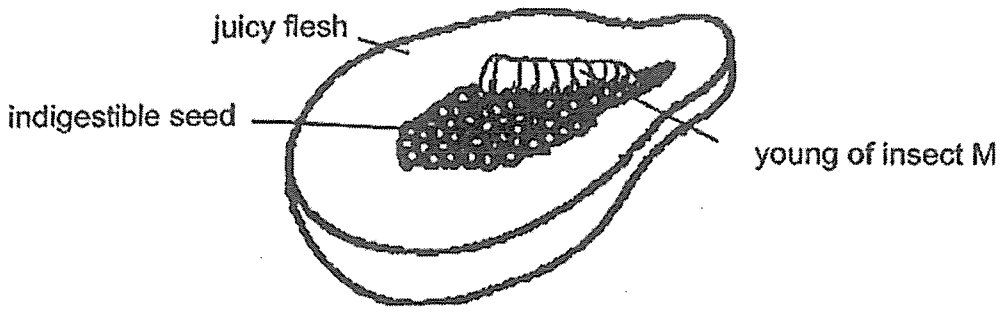

(a) State the part of the flower where insect M lays its eggs. [1]

(b) Explain how insect M pollinating the flower benefits plant Y. [1]

(c) Explain how the characteristics of the fruit of plant Y as shown in the diagram help in its dispersal. [1]

(Go on to the next page)

Score	3
-------	---

31 The table below shows the volume of blood transported per minute to some parts of the body when a person is resting and jogging.

Parts of body	Volume of blood transported per minute (units)	
	Resting	Jogging
Leg muscles	300	5700
Small intestine	1200	720

(a) Explain why there is an increase in the volume of blood transported to the leg muscles when jogging. [2]

(b) Using the information above, explain how jogging after a meal affects the absorption of digested food in the small intestine. [2]

Score	4
-------	---

0009/02(B)

32 Jay left a piece of plant P standing in red coloured water for one hour as shown.

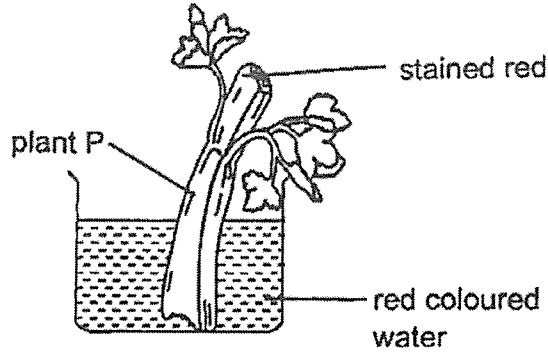

(a) Name the part of the stem that was stained red and state its function. [1]

(b) Jay conducted an experiment to investigate the effect of temperature of the surrounding air on the rate of photosynthesis of plant P. The graph shows the result of his experiment.

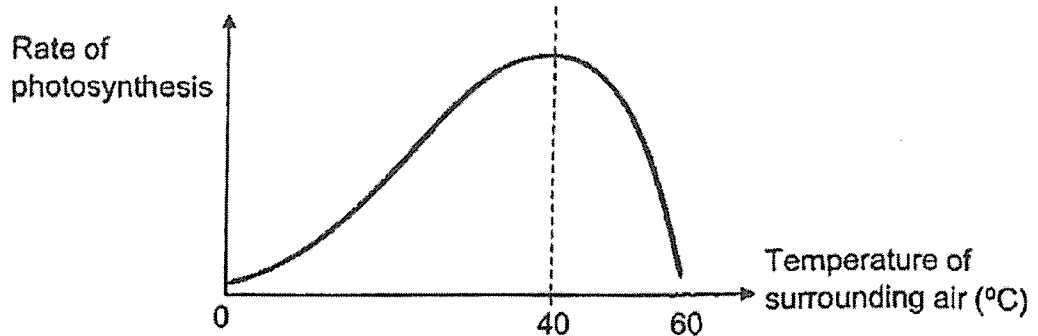

Based on the graph, describe the effect of temperature of surrounding air on the rate of photosynthesis. [2]

(c) What will happen to the rate of photosynthesis of plant P when some parts of the stem that were stained red as shown in (a) are damaged? Explain why. [1]

(Go on to the next page)

0009/02(B)

Score	4
-------	---

33 A scientist made the following observations of aquatic organisms V, W, X, Y and Z.

- W feeds on Y.
- Y and X feed on V.
- Z feeds on X including its eggs.

(a) Draw a food web to show the relationships among all the organisms above. [2]

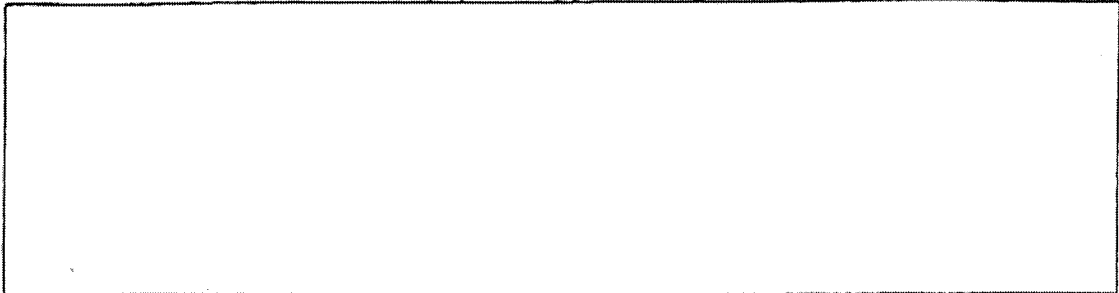

(b) Z is of a much bigger size than X. X lays its eggs inside a small cave as shown in the diagram below.

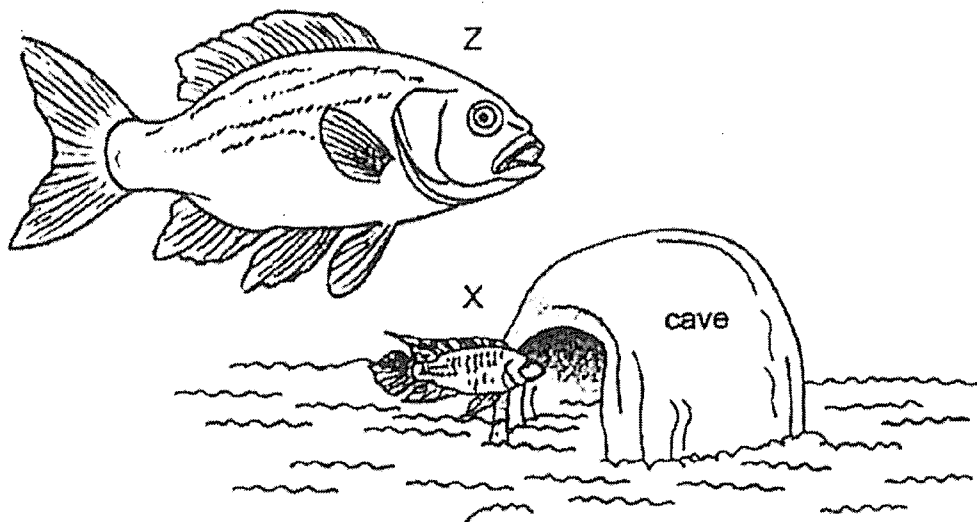

Suggest and explain how laying eggs inside a small cave impacts the survival of organism X. [2]

Score	4
-------	---

34 When moth H is disturbed by predators, it exposes its eyespots on the hindwings.

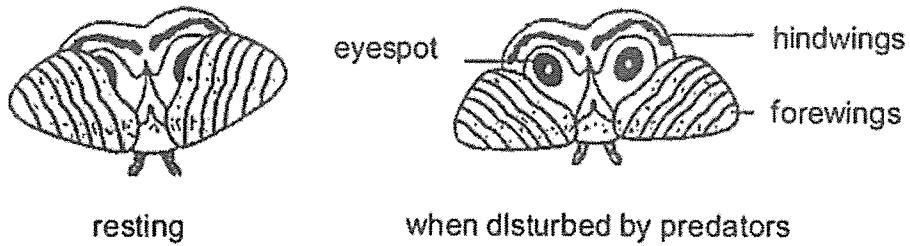

(a) Explain how and why this action helps moth H. [2]

(b) Scientists release several moths H into a forest with two types of trees, X and Y. Tree X has a darker coloured bark than tree Y. The diagram below shows moth H resting on tree X and tree Y respectively.

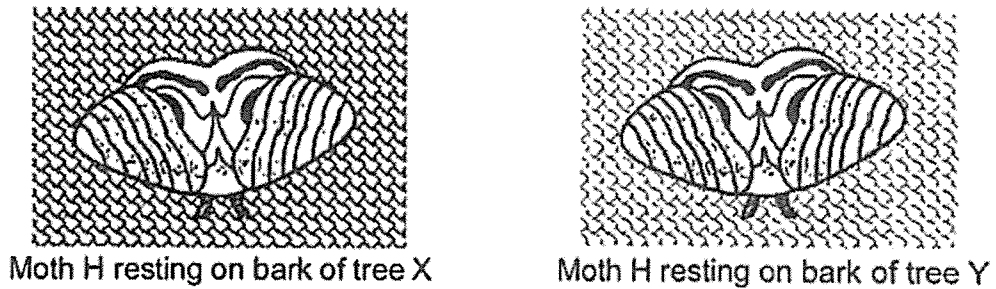

Explain why the scientists found more moth H resting on the bark of tree Y than on the bark of tree X .. [2]

(Go on to the next page)

Score	4
-------	---

35 (a) Explain how a shadow is formed. [1]

Andy set up the experiment in a dark room as shown below. The light sensor S on screen Z gave a reading of 40 units.

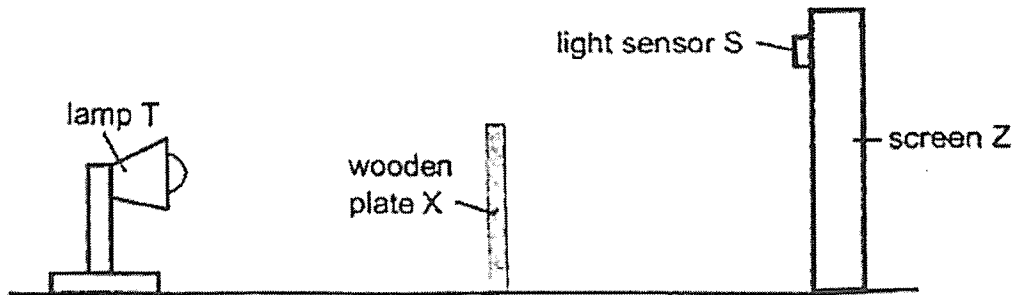

(b) As Andy moved one object in the set-up, the reading on S decreased slowly to 30 units and then dropped to 0 units suddenly.

Which object did Andy move and in which direction? Tick (✓) the correct boxes in the table below. [1]

Object	Tick (✓) the correct box	Direction	Tick (✓) the correct box
lamp T		towards wooden plate X	
wooden plate X		away from wooden plate X	
screen Z		towards lamp T	

- (c) Another object, B, was placed between the lamp and the wooden plate X as shown below.

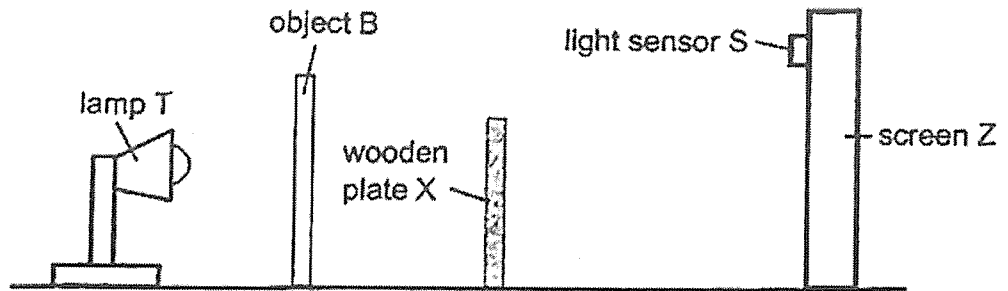

It was observed that the shadow formed on the screen remained unchanged. Explain this observation. [1]

(Go on to the next page)

Score	3
-------	---

0009/02(B)

36 Rebecca conducted an experiment using water collectors with different number of folds to collect water on non-rainy days as shown below.

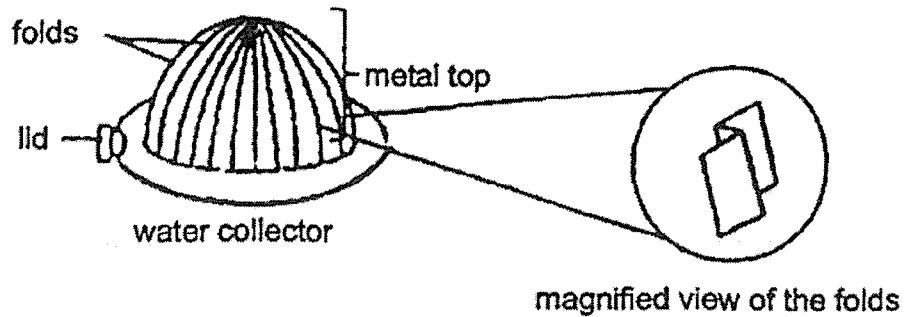

She placed the water collectors in an open area in the evening and collected the water in the morning as shown below.

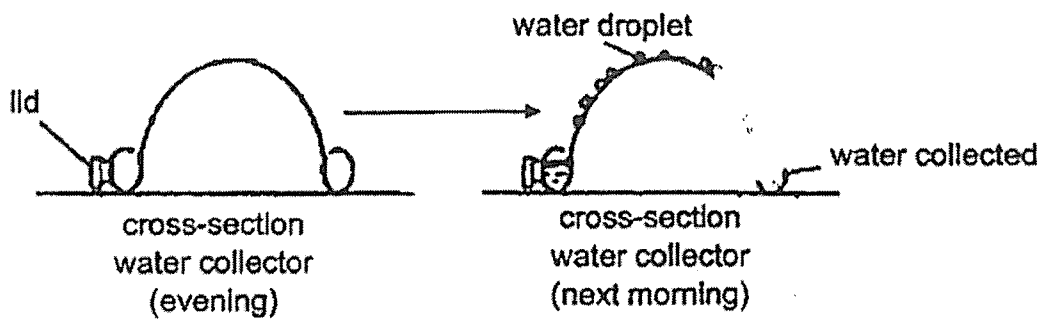

Her results are shown below.

Number of folds	0	10	20	30
Volume of water collected (cm ³)	3	4	6	8

(a) Explain how water is collected in the water collector on non-rainy days. [1]

(b) Why is metal used to make the top part of the water collector? [1]

Animal B lives in the desert.

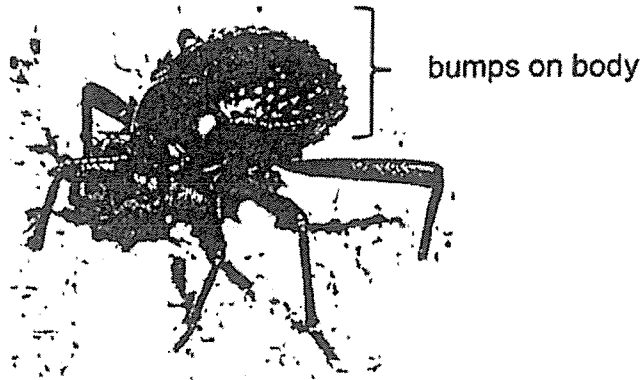

It has many bumps on its body to collect water from the surrounding air. The water will then flow into its mouth.

(c) Based on the results of Rebecca's experiment on page 10, describe and explain why having many bumps on the body is an advantage to help animal [2]

(Go on to the next page)

Score	4
-------	---

- 37 Alvin designed a circuit that produces blinking light. Contact P, bar Q and rod R are made of iron. P and R are fixed. Bar Q can be rotated at point T. When Alvin closed the switch, bar Q moved up and down between P and R repeatedly.

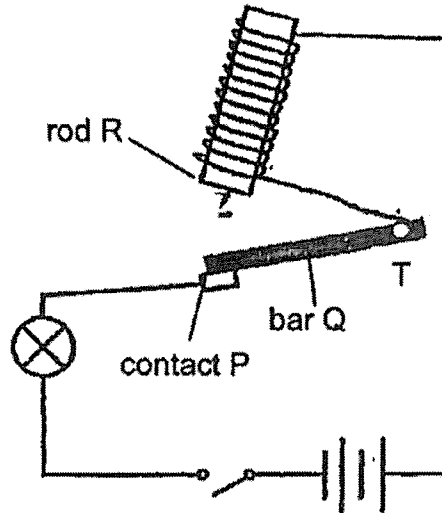

- (a) Explain why bar Q moved and touched rod R after Alvin closed the switch. [1]

- (b) When bar Q touched rod R, state and explain what would happen to rod R and the light bulb. [2]

- (c) Will the circuit still produce blinking light if contact P is changed into aluminium? Explain your answer. [1]

Score	4
-------	---

38 A laptop operating on battery is switched on. John connects his phone to the laptop as shown below.

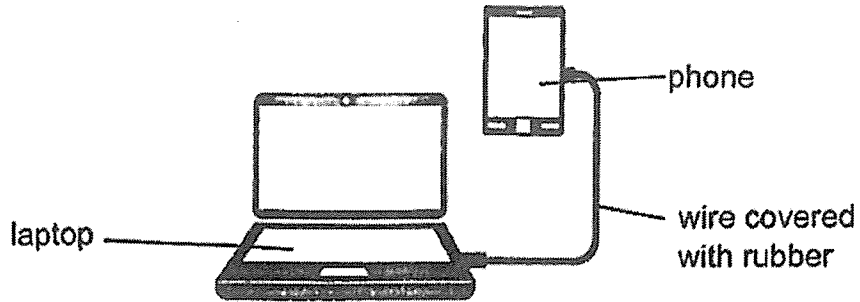

(a) Write down the energy conversion when John connects the phone to his laptop. [1]

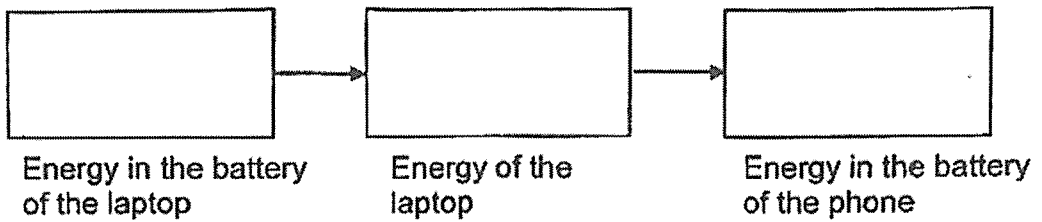

(b) How would connecting the phone affect the amount of time the laptop would operate before needing to be recharged? Explain your answer. [1]

(Go on to the next page)

Score	2
-------	---

39 (a) What is the difference between heat and temperature?

[1]

David wanted to find out which containers, X, Y or Z, that are made of different materials can keep his drink hot for the longest period of time. He poured boiling water at 100 °C into each container.

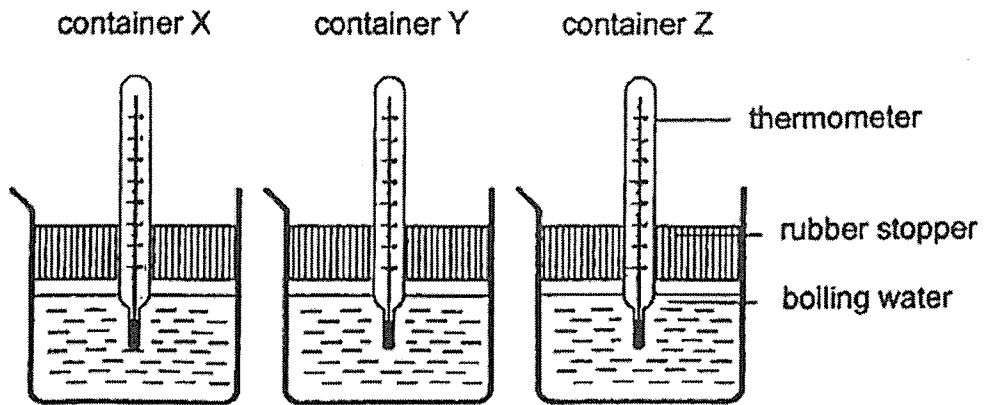

(b) Which variable(s) should David keep the same to ensure a fair test? Place a tick (✓) in the box(es) next to the variable(s) that should be kept the same. [1]

Variable	Keep the same
The amount of boiling water in each container.	
The time taken for the water to reach 50 °C.	
The type of materials used to make the container.	
The thickness of materials used to make the container.	

(Go on to the next page)

David recorded the change in the temperature of water over time and plotted the graph as shown below.

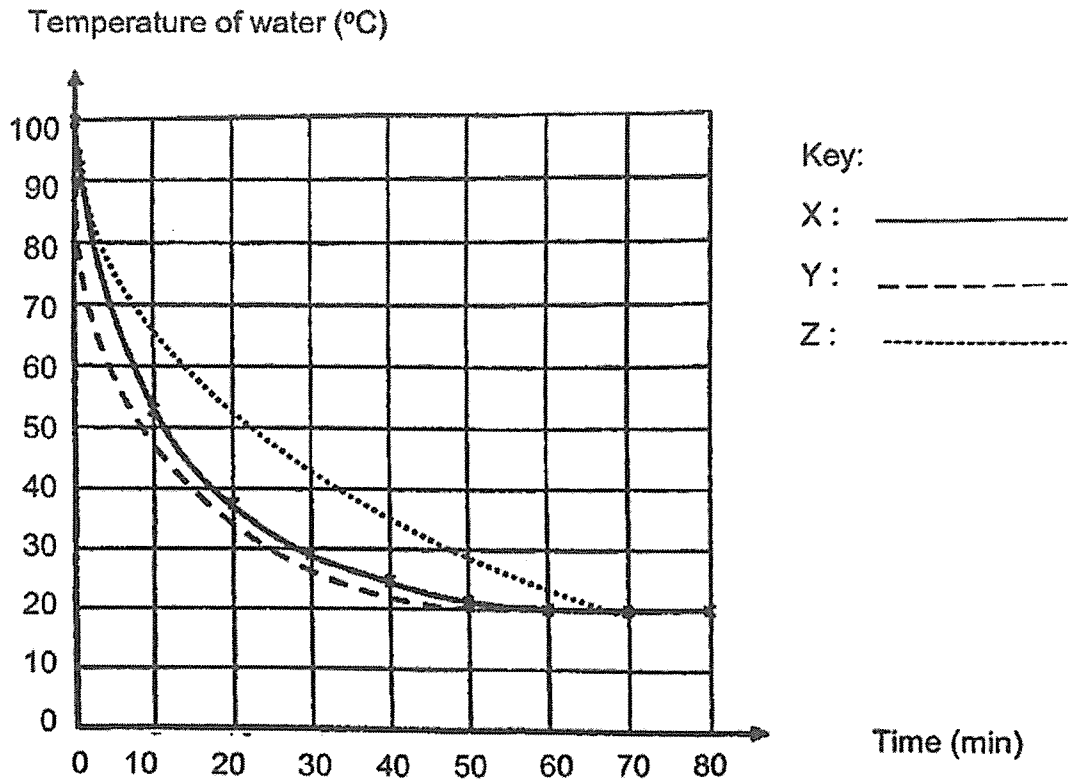

- (c) Which container, X, Y or Z, is the most suitable for keeping the water hot for the longest period of time? Explain your answer. [2]

- (d) Explain why it will be more accurate to record the temperature every minute for the first ten minutes. [1]

Score	5
-------	---

40 Andy is sitting on a rocking horse using spring H as shown below.

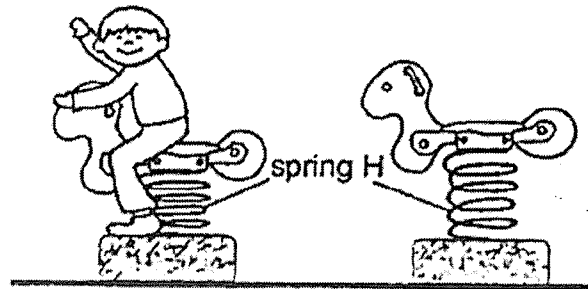

(a) Identify the force(s) acting on Andy as he sat on the rocking horse [1]

(b) Andy then conducted an experiment on springs G and H, of the same length, using the set-up as shown below.

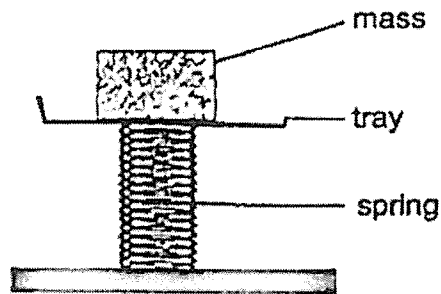

He measured the compression of each spring with different masses. His results are shown in Table 1 below.

Mass (kg)	Compression of spring G (cm)	Compression of spring H (cm)
0	0	0
5	3.1	2.2
10	6.9	4.0
15	10.7	6.2
20	12.8	8.3

Table 1

0009/02(B)

(i) Spring H was replaced with spring G in the rocking horse.

Based on the results in Table 1, would the length of the spring G be more or less than the length of spring H when Andy sat on the rocking horse again?
Explain your answer. [2]

(ii) Suggest one thing Andy could do to obtain more reliable results. [1]

End of paper

Score	
-------	---

0009/02(B)

1. The following table shows the number of students who appeared for the examination in different subjects.

Subject	Number of Students
Mathematics	120
Science	150
English	180
Hindi	100
Social Studies	140

2. The following table shows the marks obtained by a student in different subjects.

Subject	Marks
Mathematics	85
Science	90
English	75
Hindi	60
Social Studies	80

3. The following table shows the number of books sold in different months.

Month	Number of Books Sold
January	150
February	200
March	250
April	300
May	350

4. The following table shows the number of students who passed in different subjects.

Subject	Number of Students
Mathematics	100
Science	120
English	140
Hindi	80
Social Studies	110

NAN HUA PRIMARY SCHOOL
PRELIMS 2024
PRIMARY SIX
SCIENCE
Student's Answer Key

Section A (28x2) = 56marks

Qns	Ans	Qns	Ans	Qns	Ans
1	2	11	1	21	4
2	3	12	2	22	2
3	1	13	4	23	2
4	3	14	4	24	4
5	3	15	4	25	2
6	4	16	4	26	4
7	4	17	3	27	2
8	2	18	3	28	3
9	1	19	2		
10	3	20	2		

Section B (44 marks)

Qns	Answer
29a	Egg / female reproductive cell / female sex cell / ovum Sperm / male reproductive cell / male sex cell
29b	Nucleus
29c	Fertilisation occurs when the sperm /cell Q/female reproductive cell and egg/cell P/ male reproductive cell fused together.
30a	Ovary/ Ovaries
30b	For Plants – After pollination, fertilisation can occur for the flower to develop into a fruit.
30c	Animals attracted by the juicy flesh and ate the fruit/seeds. The animals passed the seeds out(waste) OR throw the seeds far away from the parent plant.
31a	Increase volume of blood (rich in oxygen and digested food) is transported to the muscles during exercise so that the supply of oxygen and digested food faster/increases to release/produce/generate more energy/ release energy faster / rate of respiration increases. Removal of carbon dioxide or waste materials.
31b	1 st point: Less blood supplied to the small intestine 2 nd point: Less (digested) food absorbed into the bloodstream OR Rate of absorption of food decreases in the bloodstream.
32a	The stem contains water-carrying tubes(part). These tubes transport water (function)
32b	As the temperate of surrounding air increases from (0 to 40°C), rate of photosynthesis increases. As the temperate increases from 40°C to 60°C, the rate of photosynthesis decreases until it stops (at 60°C)

/32c	Rate of photosynthesis will decrease because leaves of plant P is receiving less water (from the roots) which is needed for photosynthesis.
33a	<p>V → Y → W</p> <p>↓</p> <p>X</p> <p>↓</p> <p>Z</p>
33b	<p>Effect on survival:</p> <p>more eggs will hatch/ more eggs can grow into adult X to reproduce</p> <p>Any one of the reasons:</p> <p>1) Eggs not easily spotted by Z/ predators so less eggs will be eaten</p> <p>2) Z/ larger predators cannot enter cave to eat the eggs/ Organism X has a smaller opening to guard the eggs.</p>
34a	<p>How - The eyespots make the moth looks like/mimic the eyes of a large(r) animal/ owl.</p> <p>Why – Its predator will be scared/deceived/tricked to think of it as a bigger animal and will not attack/ eat the moth.</p>
34b	<p>Evidence: Moth H has light-coloured forewings and hindwings.</p> <p>Reason: Moth H can blend into/camouflage against the bark of tree Y so it is harder for it to be spotted (by its predator).</p>

35a	A shadow is formed when the light is blocked by (an opaque or translucent) an object.
35b	<p>✓screen Z</p> <p>✓away from wooden plate X</p>
35c	Object B allow <u>most</u> light to pass through/is transparent.
36a	<p>For condensation to take place, there must be difference in temperature.</p> <p>The warmer water vapour from the surroundings will come into contact with the colder surface of the metal top/water collector, lost heat and condense to form water droplets.</p>
36b	Metal is a good conductor of heat.
36c	The bumps increase the (exposed) surface area in contact with surroundings/between the insect's body surface and the water vapour in the surroundings. This will increase the rate of condensation / more water vapour can condense and more water to drink/ to survive.
37a	<p>When the switch is closed, the electric current can flow through the circuit.</p> <p>Rod R would become an electromagnet / magnetised / temporary magnet.</p> <p>Rod R would attract/pull bar Q or Bar Q was attracted to Rod R.</p>
37b	<p>After bar Q touched rod R, the circuit would be open.</p> <p>The electric current would not flow through the circuit.</p> <p>Rod R would no longer be an electromagnet/ no longer magnetised / demagnetised / lose its magnetism.</p> <p>The light bulb would not light up / switched off.</p>
37c	Yes. Aluminium is a conductor of electricity / electrical conductor.

38a	<p>(Chemical) potential energy</p> <p>Electrical energy</p> <p>(Chemical) potential energy</p>
38b	<p>The amount of time the laptop would operate is shorter / The laptop will need to be recharged faster.</p> <p>The laptop needs to supply energy to itself and the phone. / Some/More (chemical) potential energy of battery of laptop will be converted to some/more electrical energy of laptop and then converted to some/more (chemical) potential energy of battery of phone.</p>
39a	<p>Heat energy is a form of energy but temperature is the measurement of degree of hotness of an object.</p>
39b	<p>The amount of boiling water in each container.</p> <p>The thickness of materials used to make the container.</p>
39c	<p>(Ch) Z</p> <p>(E) The temperature of water in container Z decreases the slowest.</p> <p>(C) Hence Z is the poorest conductor of heat.</p> <p>(L) The water in container Z loses heat to the surroundings the slowest.</p>
39d	<p>Temperature is changing / decreasing quickly or fast or drastically. / Temperature decreased the most. / Sharp decrease in temperature.</p> <p>Heat is lost (more) easily / quickly / fast. / The water is losing heat the most.</p>
40a	<p>Gravity/ gravitational force</p> <p>Friction/ frictional force</p>

40b(i)	The length of spring G will be less than the length of spring H. Spring G compresses more than spring H when the same mass is hung on them. Hence, spring G is less stiff.
40b(ii)	He can repeat the experiments a few more times/two more times and find the average results / until the results are consistent.