

Index No:

--	--	--	--	--

 -

--

Name: _____ ()
Class: Primary 6

22 August 2024



SINGAPORE CHINESE GIRLS' SCHOOL
PRELIMINARY EXAMINATION 2024

PRIMARY 6

SCIENCE

BOOKLET A

Total Time for Booklets A and B: 1h 45 min

INSTRUCTIONS TO CANDIDATES

1. Write your Index No. in the boxes at the top right-hand corner.
2. Do not turn over this page until you are told to do so.
3. Follow all instructions carefully.
4. Answer all questions.
5. Use a 2B pencil to shade your answers on the Optical Answer Sheet (OAS).

This booklet consists of 20 printed pages.

For each question from 1 to 28, four options are given. One of them is the correct answer. Make your choice (1, 2, 3 or 4). Shade your answer on the Optical Answer Sheet.

[56 marks]

1 The diagrams below show two organisms.

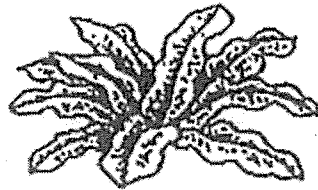

fern

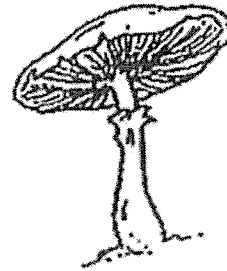

mushroom

How are the two organisms similar?

- (1) They do not have roots.
- (2) They do not have stems.
- (3) They reproduce by spores.
- (4) They do not make their own food.

2 Study the classification chart below.

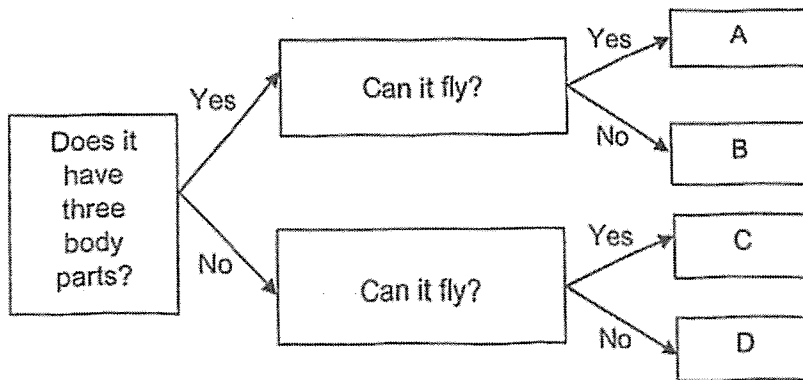

Which of the following statements is correct ?

- (1) C is a bat.
- (2) B is a spider.
- (3) A and B are birds.
- (4) B and D are mammals.

- 3 Belle drew the diagram below to show the direction of blood flow in the human circulatory system.

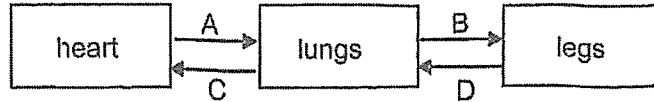

Which arrows are drawn correctly?

- (1) A and B only
 - (2) A and C only
 - (3) B and D only
 - (4) All of the above
- 4 Study the information in the table below.

	Found in	
	flowering plant	human
Male reproductive cell	Anther	B
Female reproductive cell	A	C

Which of the following correctly identifies A, B and C?

	A	B	C
(1)	ovules	penis	ovary
(2)	ovary	penis	ovules
(3)	ovary	testes	ovules
(4)	ovules	testes	ovary

- 5 Mr Tan found some weeds growing among his plants in his garden as shown in the diagram, below.

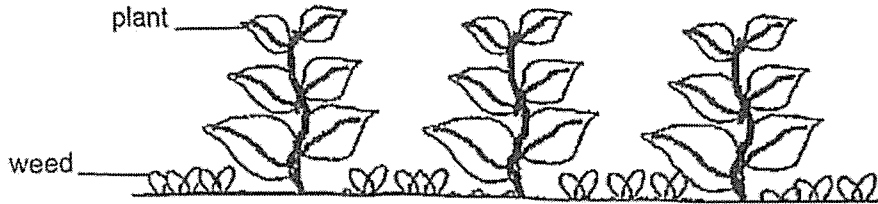

He found that his plants were not growing healthily when the weeds started growing. Based on the diagram above, which of the following best explains why Mr Tan's plants were not growing healthily?

- (1) The weeds competed with the plants for air.
 - (2) The weeds competed with the plants for water.
 - (3) The weeds competed with the plants for warmth.
 - (4) The weeds competed with the plants for sunlight.
- 6 The life cycle of a flowering plant is shown below. C and D represent stages in the life cycle.

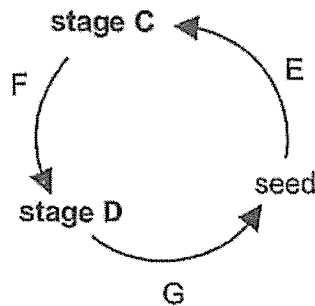

Which of the following is correct?

	pollination	germination
(1)	G	E
(2)	F	E
(3)	G	F
(4)	F	G

- 7 Devi investigated the effect of light and water on mould growth on bread. She set up an experiment using three pieces of bread, R, S and T, from the same loaf. The bread were toasted. Different amounts of water were sprayed on the bread before being placed in different locations. Devi observed the following results on Day 5.

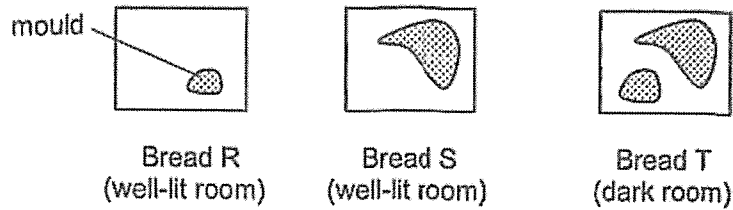

Bread	Number of sprays of water
R	0
S	3
T	3

What can she conclude from the investigation?

- A Mould needs warmth to grow.
 - B Mould grows faster in the dark.
 - C Mould does not need light to grow.
 - D Mould grows faster without water.
- (1) A and B only
 (2) B and C only
 (3) A, B and C only
 (4) B, C and D only

- 8 A ring of stem from a plant was removed as shown below. As a result, the tubes carrying food were removed.

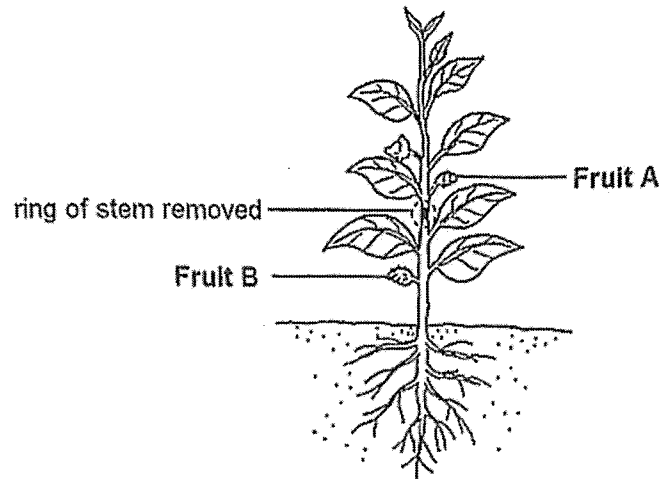

Which of the following correctly describes the appearance of fruits A and B after a week?

	Fruit A	Fruit B
(1)	increases in size	increases in size
(2)	increases in size	remains the same
(3)	decreases in size	decreases in size
(4)	remains the same	increases in size

- 9 The diagram below shows what happens when an animal cell is placed in a beaker containing substances Y and Z.

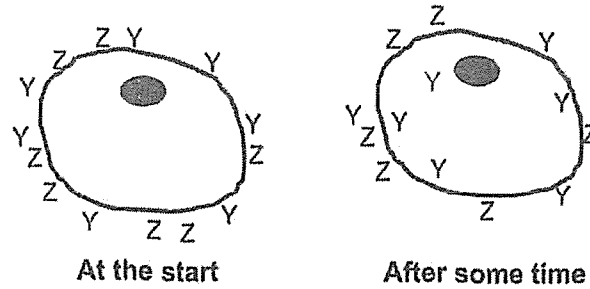

Based on the information above, which of the following correctly describes the cell membrane?

- (1) It gives the cell a regular shape.
 - (2) It controls the activities in the cell.
 - (3) It allows substance Z to leave the cell.
 - (4) It allows substance Y to enter the cell.
- 10 Study the food chain shown below.

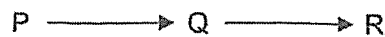

When organism S was introduced into the environment, the population of Q increased.

Which of the following is **not** a possible reason?

- (1) Organism S is a plant.
- (2) Organism S feeds on P.
- (3) Organism S is a prey of R.
- (4) Organism S is a predator of R.

- 11 Firas recorded the different organisms he saw at the school pond in the table below.

Organism	Number
tadpole	3
guppies	4
frog	1
dragonfly	2
water lettuce	5
duckweed	10
water lotus	1

How many populations of producers and consumers are in this habitat?

	Number of populations of	
	producers	consumers
(1)	3	4
(2)	3	3
(3)	2	3
(4)	2	4

- 12 Marian prepared set-ups A, B and C as shown in the diagram below. She measured the amount of oxygen in each of the containers before leaving them in an open field for a day.

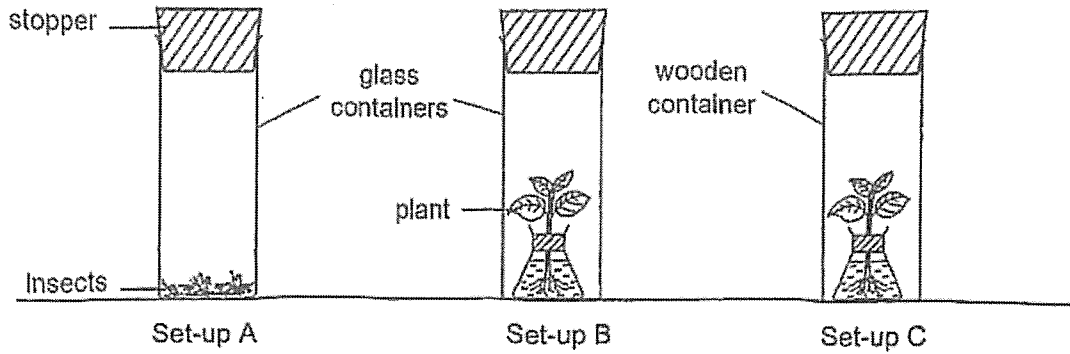

At the end of her experiment, Marian measured the amount of oxygen in each of the containers again.

Which of the following shows the change in the amount of oxygen in each of the set-ups at the end of the experiment?

	A	B	C
(1)	increase	no change	increase
(2)	decrease	increase	increase
(3)	decrease	increase	no change
(4)	decrease	increase	decrease

- 13 Haziq used fruit P shown below to find out the average time taken for it to reach the ground when it is released from a height.

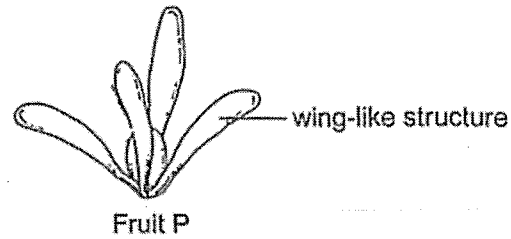

He conducted three experiments at the same location. The results of his experiments are recorded as shown.

Experiment	Number of wing-like structures	Height of drop (cm)	Average time taken for fruit to reach the ground (s)
1	4	150	5.6
2	4	H	4.7
3	2	150	T

What are the possible values of H and T ?

	H	T
(1)	110	4.2
(2)	110	5.9
(3)	180	4.2
(4)	180	5.9

- 14 Topsoil is the most fertile soil for plant growth. An experiment is conducted as shown below. The same amount of water is poured from the top of each of the three sections of a slope of soil.

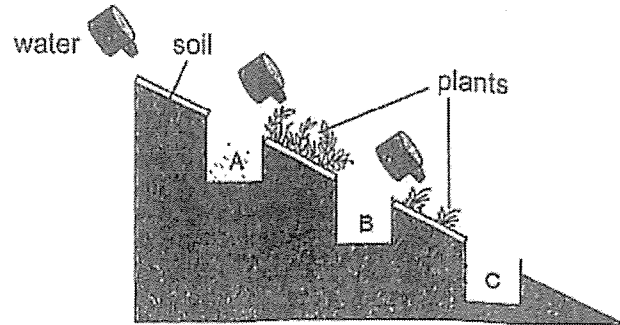

The amount of soil collected in each section is measured.

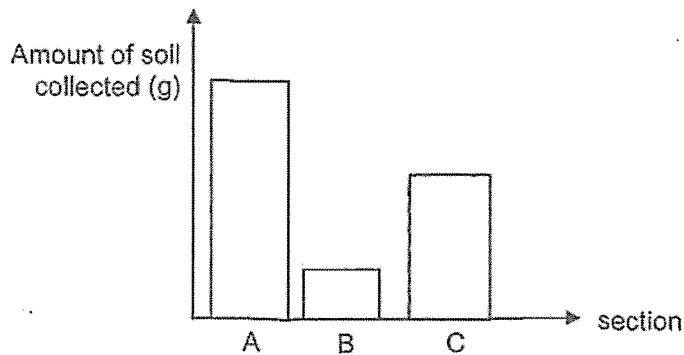

Which of the following conclusion(s) can be drawn from the experiment above?

- A Deforestation leads to global warming.
- B Deforested areas have less topsoil.
- C The roots of plants held the soil together to reduce soil erosion.
- D The roots absorbed all the water in the soil.

- (1) A only
- (2) A and C only
- (3) B and C only
- (4) C and D only

- 15 The table below shows the properties of four materials, A, B, C and D. A tick (✓) indicates the presence of property in the material.

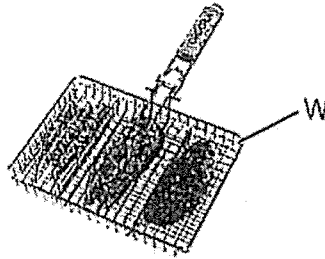

Which material, A, B, C or D, is suitable to make part W which is used for grilling of food?

	Material	Property			
		strong	flexible	allows light to pass through	good conductor of heat
(1)	A			✓	
(2)	B			✓	
(3)	C	✓			✓
(4)	D			✓	✓

- 16 Magnet Q was fixed to the table. Magnet R was brought close to Magnet Q as shown below.

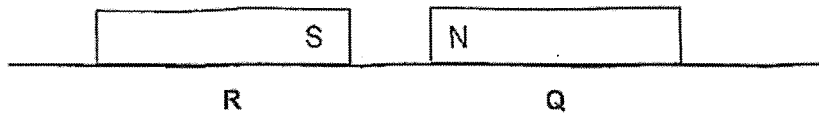

Which of the following shows the direction of the different forces acting on magnet R?

	Magnetic force	Frictional force	Gravitational force
(1)	←	→	↑
(2)	→	→	↑
(3)	←	←	↓
(4)	→	←	↓

- 17 The graph shows the length of four rubber bands, A, B, C and D, when a load is hung onto them.

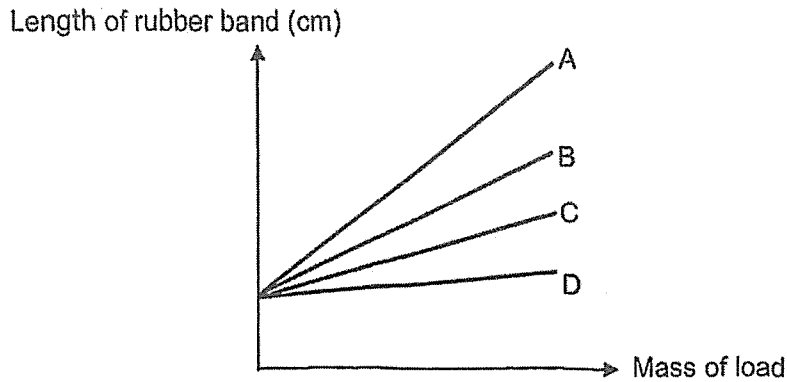

Kumar wants to choose an elastic band to make a catapult that can launch a stone over the greatest distance when pulled back by a fixed length.

Which rubber band, A, B, C or D, should Kumar choose?

- (1) A
 - (2) B
 - (3) C
 - (4) D
- 18 The dentist uses a mouth mirror to examine the teeth of her patient.

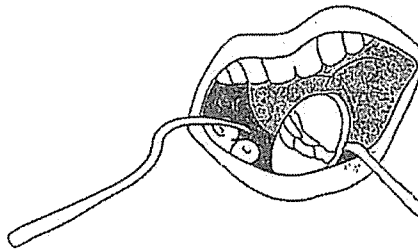

Which of the following best explains how the dentist is able to see the teeth in the mouth mirror ?

- (1) The mouth mirror shines light onto the teeth for the dentist to see.
- (2) The mouth mirror reflects light from the teeth for the dentist to see.
- (3) The mouth mirror absorbs light from the teeth for the dentist to see.
- (4) The mouth mirror allows light to pass through the teeth for the dentist to see.

19 Eskimos build igloos with ice blocks for shelter as shown in the following diagram.

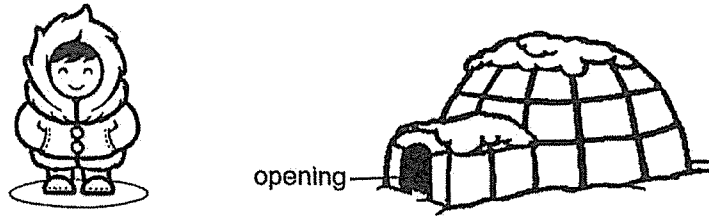

Which of the following best explains how the igloos keep the Eskimos warm?

- (1) Coldness in the surrounding air is conducted into the igloos slowly as the ice is a poor conductor of heat.
- (2) Coldness in the surrounding air cannot enter due to the tiny opening of the igloo.
- (3) Heat from the hot air inside the igloo cannot be conducted out of the igloo as ice is a poor conductor of heat
- (4) Heat from the hot air inside the igloo is conducted out of the igloo slowly as ice is a poor conductor of heat.

20 The diagram below shows a head torch powered by batteries.

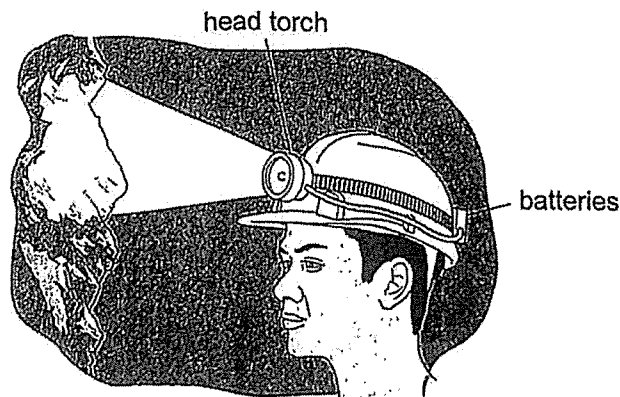

Which of the following correctly shows the energy changes in the head torch?

- (1) potential energy → heat energy → light energy
- (2) electrical energy → light energy + heat energy
- (3) potential energy → electrical energy → light energy + heat energy
- (4) electrical energy → potential energy → light energy + heat energy

- 21 Deming pasted a film on a glass window to reduce the amount of sunlight coming into the room. Some air bubbles were trapped under the film as shown below.

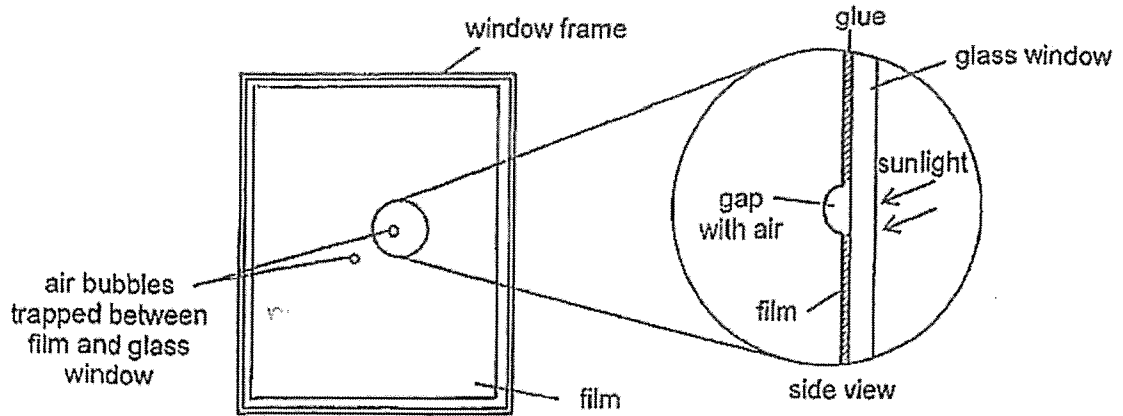

What will happen to the total volume and the mass of air in the gap if the weather becomes very hot for a few weeks?

	Volume of air in the gap	Mass of air in the gap
(1)	increase	remain the same
(2)	increase	increase
(3)	remain the same	increase
(4)	remain the same	remain the same

23 The table below shows the melting and boiling point of three substances, E, F and G.

Substance	Melting Point (°C)	Boiling Point (°C)
E	2	29
F	10	21
G	32	50

Jiaqi wants to store the substances for a long period of time.

Which of the following substance(s) has to be stored in a sealed container at 30 °C to prevent it from escaping into the surroundings?

- (1) F only
- (2) E and F only
- (3) E and G only
- (4) E, F and G

24 Study the circuit diagram below. Materials P, Q and R were connected to the circuit below.

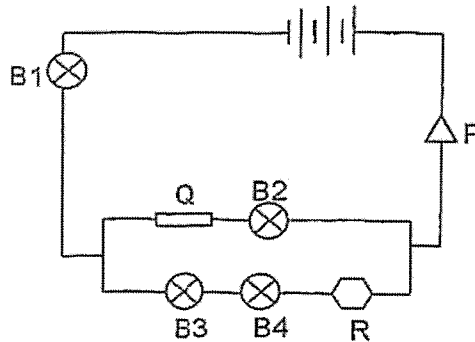

Which one of the following most likely represents the materials, P, Q and R, and the number of bulbs that lighted up?

	P	Q	R	Number of lit bulbs
(1)	steel	glass	aluminium	4
(2)	aluminium	iron	glass	3
(3)	glass	copper	steel	2
(4)	copper	glass	iron	3

- 25 Davinia noticed that the green exit sign above the door was faulty. Only the bulbs behind three letters, X, I and T were lit, but the letter E was not.

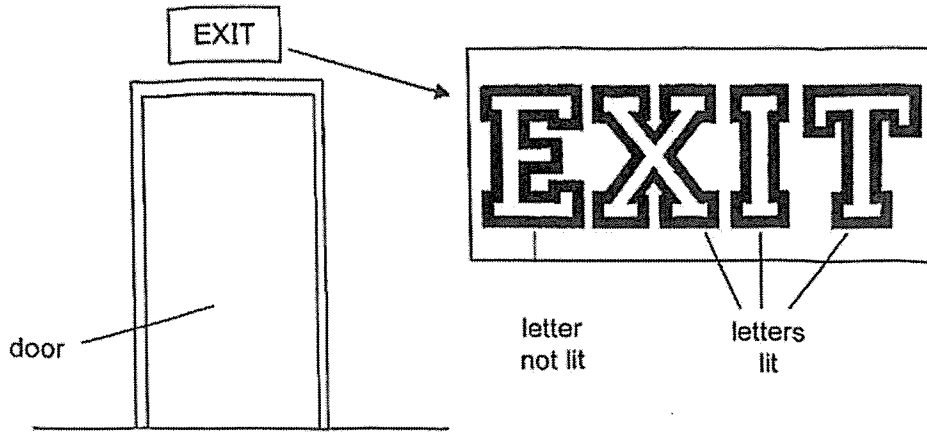

All the components used are identical and in good working condition. Which of the following shows the correct arrangement of the circuit?

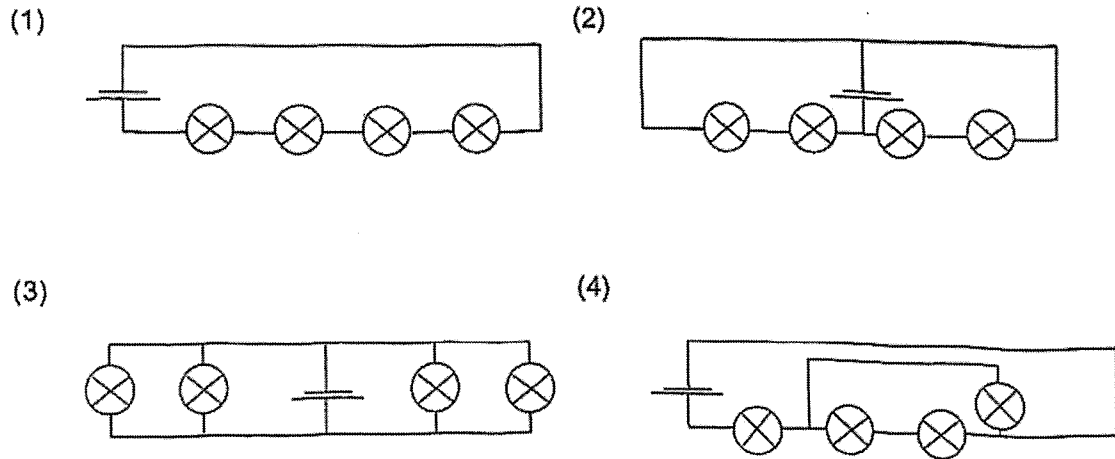

- 26 The graph shows the extension of spring Q and spring R when different loads were hung on them. The initial length of Springs Q and R were 8 cm.

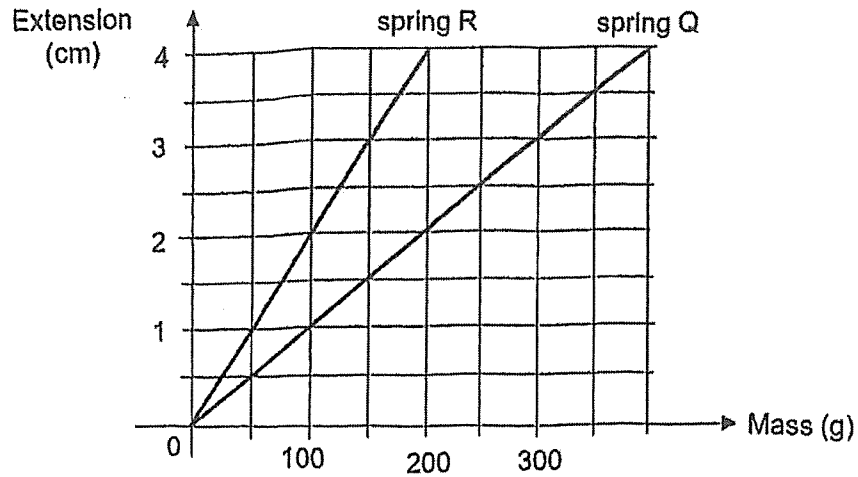

Which of the following is correct?

	mass of load when final length of spring Q is 10 cm (g)	final length of spring R with 200 g load (cm)
(1)	100	10
(2)	200	12
(3)	100	12
(4)	200	10

27 Karen has three wooden frames P, Q and R as shown below.

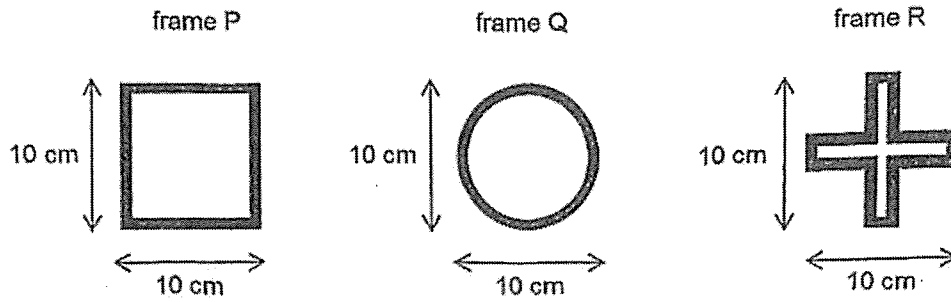

She hung the frames between a lamp and a screen. The shadows formed on the screen are shown below.

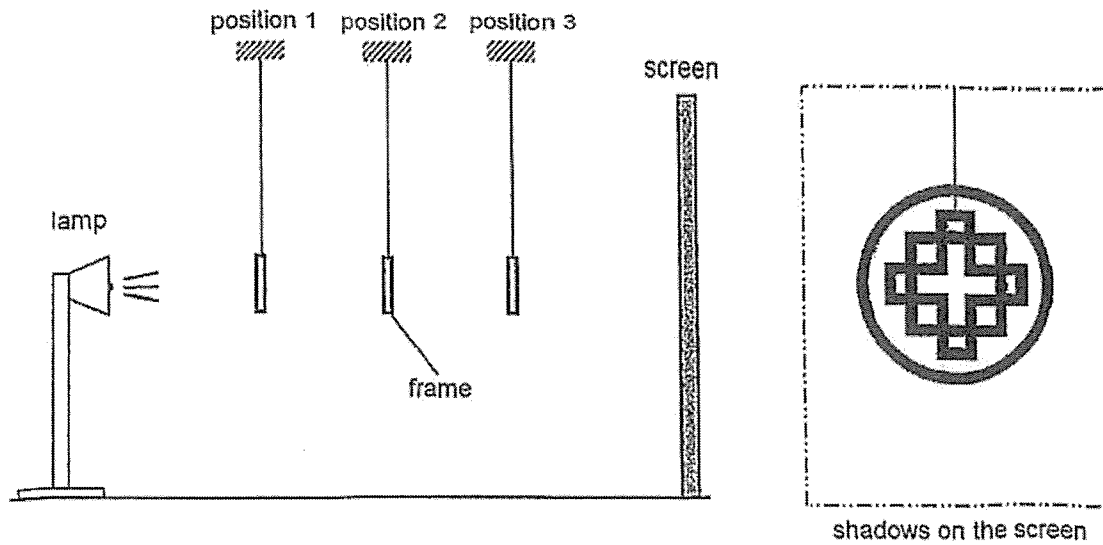

Which of the following correctly shows the positions of frames P, Q and R?

	Position 1	Position 2	Position 3
(1)	Q	R	P
(2)	P	Q	R
(3)	Q	P	R
(4)	R	P	Q

- 28 A ball is rolled down a slope. The graph shows the amount of different types of energy of the ball at point P.

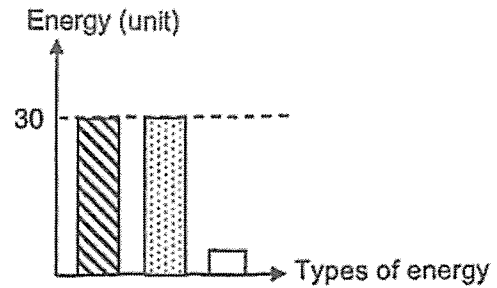
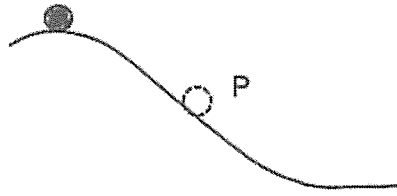

Key

▨ potential energy ▤ kinetic energy □ heat energy

The experiment is repeated with sand applied on the slope. Which graph correctly shows the amounts of different types of energy at P?

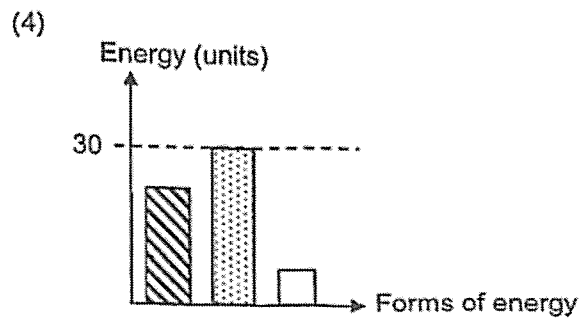
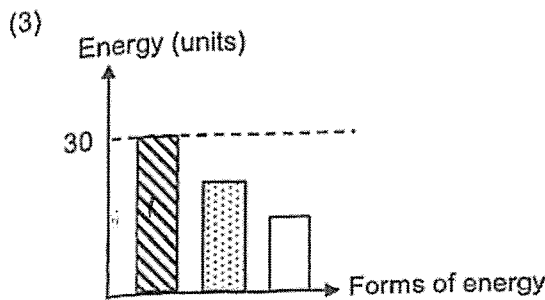
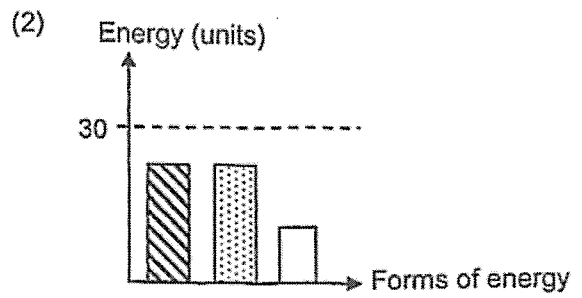
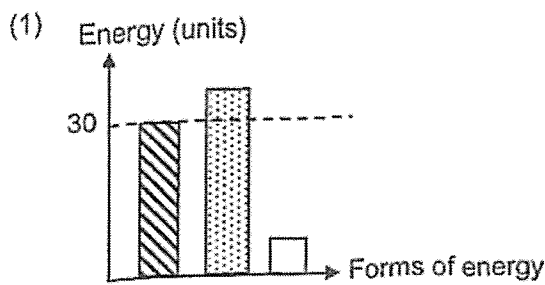

END OF BOOKLET A

Index No:

--	--	--	--	--

 -

--

Name: _____ ()

22 August 2024

Class: Primary 6

	<p>SINGAPORE CHINESE GIRLS' SCHOOL PRELIMINARY EXAMINATION 2024</p> <p>PRIMARY 6</p> <p>SCIENCE</p> <p>BOOKLET B</p> <p>Total Time for Booklets A and B: 1h 45 min</p>
---	---

INSTRUCTIONS TO CANDIDATES

1. Write your Index No. in the boxes at the top right-hand corner.
2. Do not turn over this page until you are told to do so.
3. Follow all instructions carefully.
4. Answer all questions.

This booklet consists of 17 printed pages.

For questions 29 to 40, write your answers in this booklet.
The number of marks available is shown in brackets [] at the end of each question or part question.

[44 marks]

29 (a) Study the information below.

- V is the food producer.
- X is the only plant-eater.
- W feeds on animals only.

Complete the food web to show the food relationships among V, W, X, Y and Z. [1]

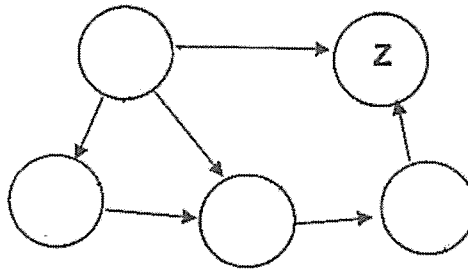

(b) Which organism (s) is / are both a prey and a predator. [1]

(c) The diagram below shows the fruit of organism V that has been cut open.

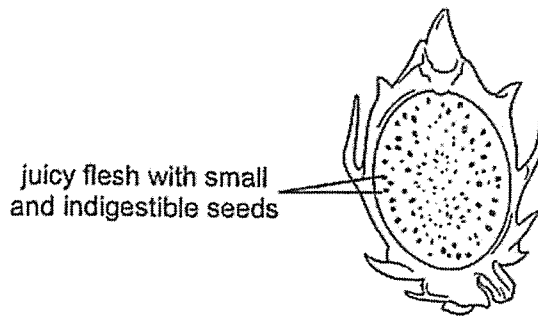

Explain how organisms that feed on V help in its seed dispersal. [1]

(Go on to the next page)

SCORE	3
-------	---

30 Animal P is usually found perching on the back of animal C as shown below. Animal P feeds on pests that hide in the hair of animal C. Pests feed on the blood of animal C.

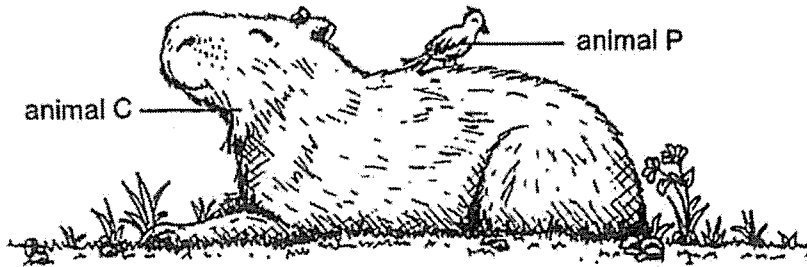

(a) Based on the information given above, describe how Animal P and C benefit from their relationship with each other. [2]

(i) Benefit for Animal P: _____

(ii) Benefit for Animal C: _____

Animal C lives in forested areas near rivers. On hot days, it dips itself in the water to wet its body from time to time.



(b) Explain how the dipping in the water to wet its body help keep animal C cool. [1]

(Go on to the next page)

SCORE	/
	3

31 (a) Describe how the digestive system and circulatory system work together in our body. [2]

The diagram below shows the changes in the amount of digested food as it goes through the different parts of the digestive system.

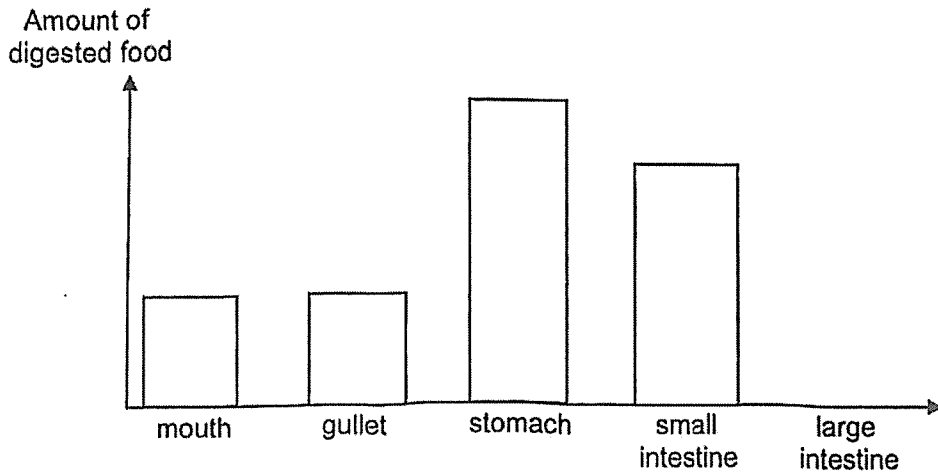

(b) Why is there no change in the amount of digested food in the gullet? [1]

(c) The elderly usually have few teeth left. They have difficulty eating big pieces of food. Explain how having few teeth could result in a lower rate of digestion. [1]

(Go on to the next page)

SCORE	/
	4

32 Mosquito A spreads disease D in humans. The diagram below shows its life cycle.

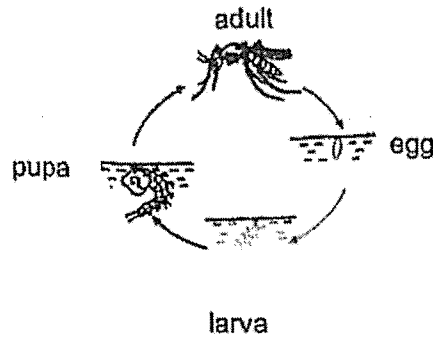

An experiment was conducted to find out how the surrounding temperature would affect the duration the eggs take to develop into adult mosquitoes. The results are shown in the table below.

	Surrounding temperature (°C)			
	28	30	32	34
Duration of egg stage (days)	14	11	9	7

(a) State how the surrounding temperature would affect the length of one complete life cycle of Mosquito A. [1]

In country S, its temperature and amount of rainfall affect the number of disease D cases. The graph below shows the average monthly temperature and amount of rainfall in country S.

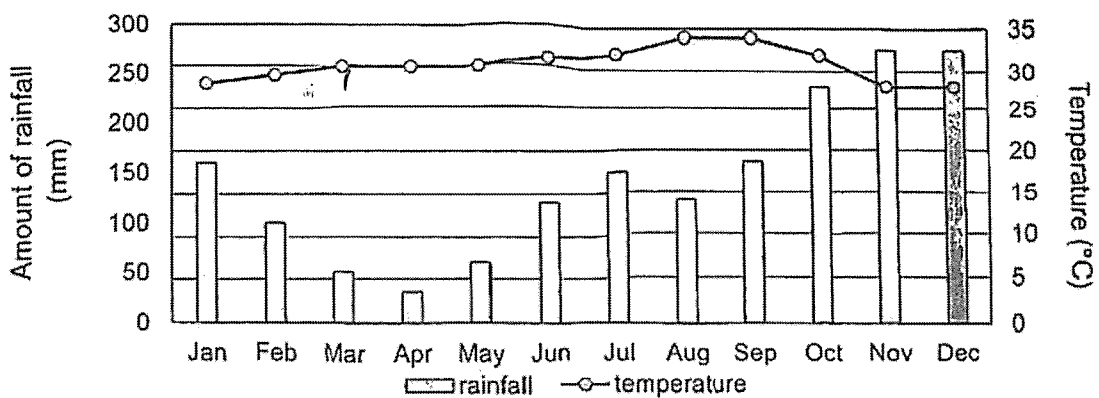

Question 32 continues next page

(b) Based on the information given, in which period would there be an increase in disease D cases? Put a tick (✓) in the correct box.

- Between January and June
- Between July and December

State two reasons for your answer. [2]

Reason 1: _____

Reason 2: _____

A device is put at different locations with a high number of disease D cases. This device contains a liquid that attracts female mosquitoes A that are looking for places to lay eggs. The mesh-like netting at the base of the inner cup traps the adult mosquitoes that emerge from the pupae.

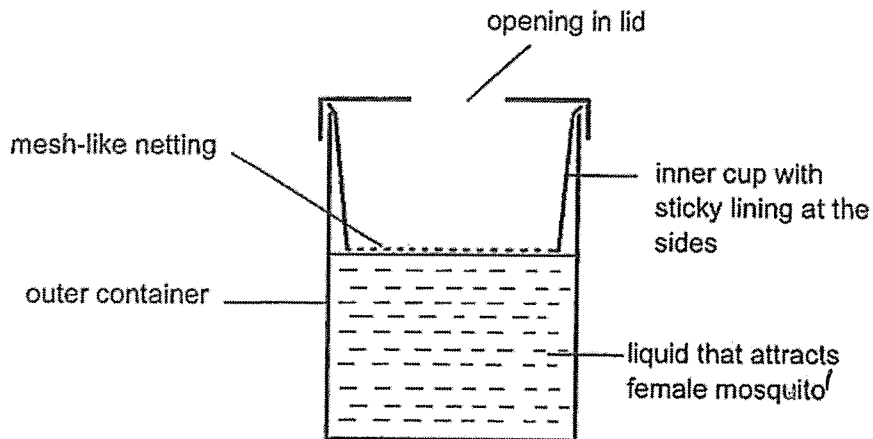

(c) Besides trapping the mosquitoes under the netting, explain another way how this device help to reduce the number of cases of disease D. [1]

(Go on to the next page)

SCORE	4
-------	---

- 33 (a) Four parts of a plant are shown below. Draw arrows (\longrightarrow) in the diagram below to show how water is transported in a plant. [1]

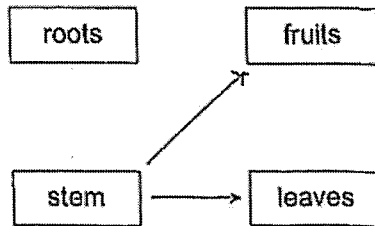

- (b) Describe the process of photosynthesis in green plants. [1]

Meixin conducted an experiment to find out how temperature affects the number of bubbles produced by a water plant.

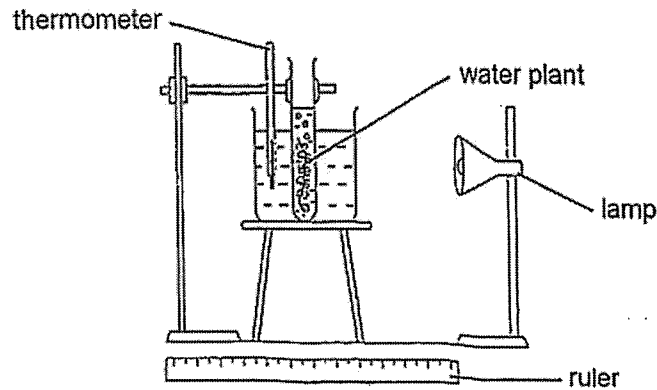

She set the temperature of water at 10 °C and switched on the lamp. She counted the number of bubbles produced per minute. She repeated the experiment at 20 °C and 30 °C. Her results are shown below.

Temperature of water (°C)	Number of bubbles produced per minute
10	4
20	11
30	24

Question 33 continues next page

- (c) Meixin wants to conduct another experiment to find out how the intensity of light affects the number of bubbles produced.

Describe how Meixin could carry out the experiment without changing any of the apparatus in the set-up above. [2]

(Go on to the next page)

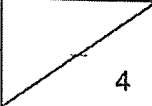
SCORE	
-------	---

34 Sea turtles live in the sea but lay their eggs on beaches.

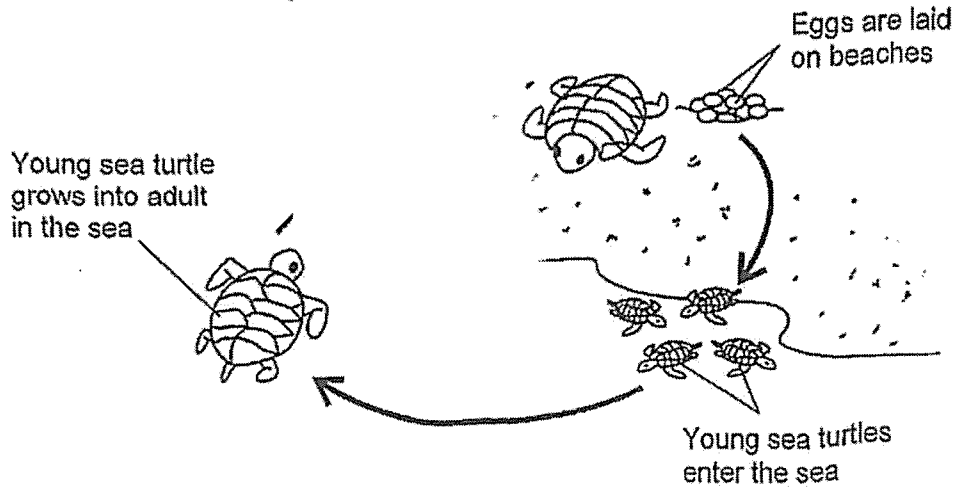

The population of sea turtles is decreasing due to global warming.

(a) State two human activities that result in global warming. [1]

(b) Explain how global warming causes the sea turtles to lose the place for laying eggs. [1]

The information below shows how temperature affects the young of animal X developing inside the eggs to be a male or a female.

Temperature (°C)	Gender of young produced
Between 30 and 35	Male
Between 35 and 40	Female

(c) Based on the information above, suggest a reason why the population of sea turtles will decrease when the temperature of the surroundings rises above 35°C due to global warming. [1]

(Go on to the next page)

SCORE	3
-------	---

- 35 The diagram below shows a test tube filled with some limewater. Limewater turns chalky in the presence of carbon dioxide. Sally blew air into the limewater several times through the delivery tube.

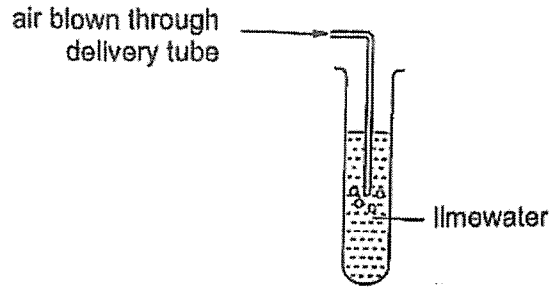

- (a) State why the limewater in the test tube turned chalky after Sally blew into it. [1]

- (b) Name the gas that remained unchanged in the air Sally took in and blew out. [1]

The diagram below shows a bus on a rainy day. It was observed that water droplets started forming on the inside of the window even though no rain could get in.

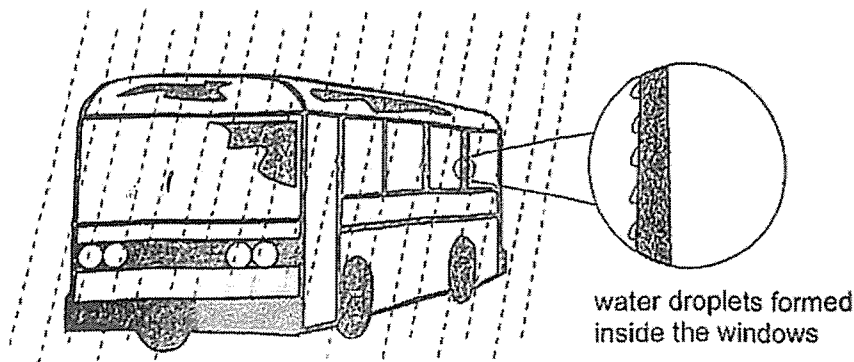

Question 35 continues next page

The graph below shows how the number of passengers affect the amount of water droplets formed on the windows.

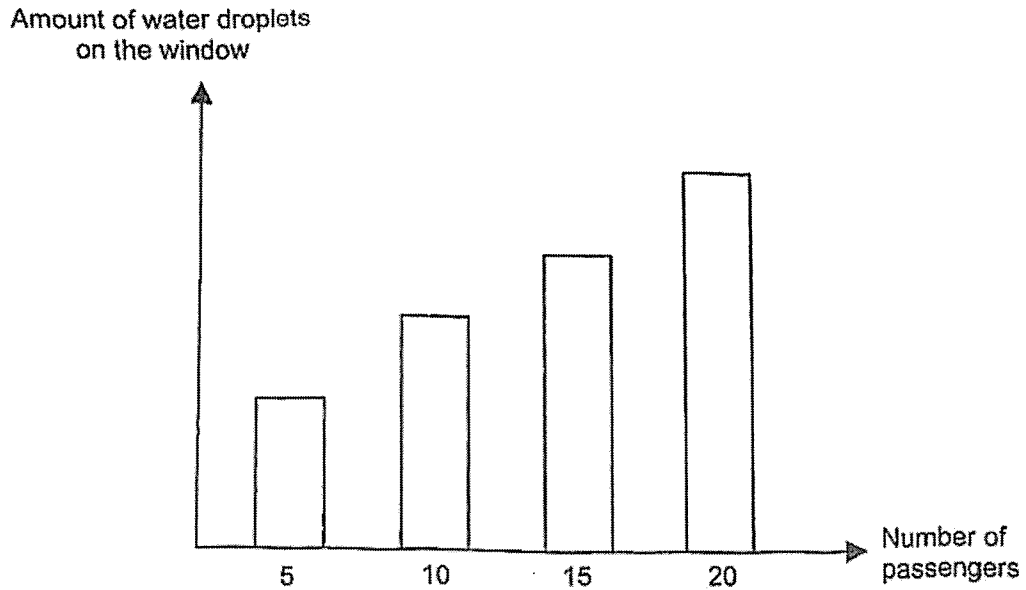

- (c) Explain the relationship between the amount of water droplets formed on the windows and the number of passengers. [2]

AS

(Go on to the next page)

SCORE	
-------	--

36 (a) State what melting means.

[1]

In an experiment, Stacy investigated the effect of substance X on crushed ice. She placed an equal amount of crushed ice in two funnels and added substance X to one funnel as shown below.

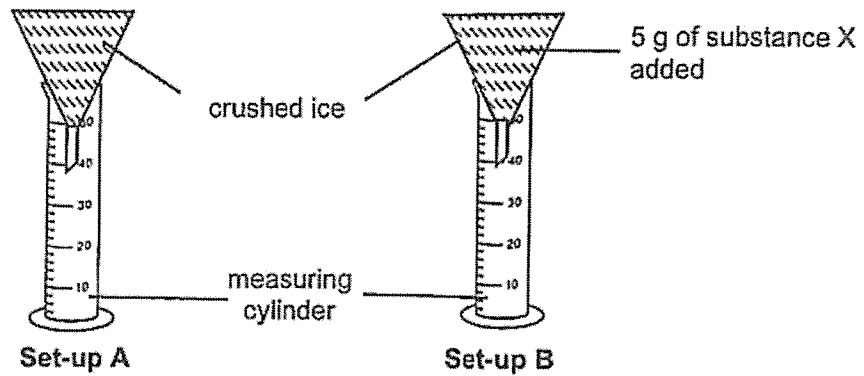

She measured the volume of water collected in each cylinder after 20 minutes and recorded the results in the graph shown below.

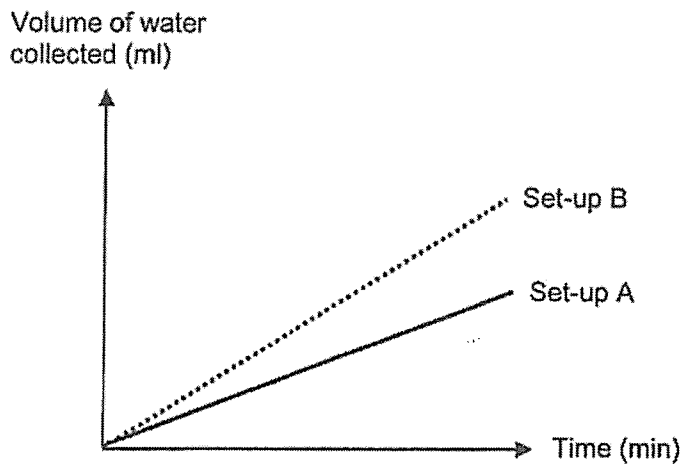

(b) Based on the results of the experiment, what is the effect of substance X on the melting point of ice? [1]

Question 36 continues next page

It is a common practice in some countries to sprinkle substance X on the roads.

- (c) Based on the results of the experiment, explain how sprinkling substance X on the roads help vehicles move through more easily after a heavy snowfall. [1]

(Go on to the next page)

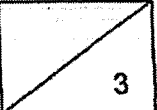
SCORE	
-------	---

37 A heat camera can detect different temperatures. Each number represents a different colour.

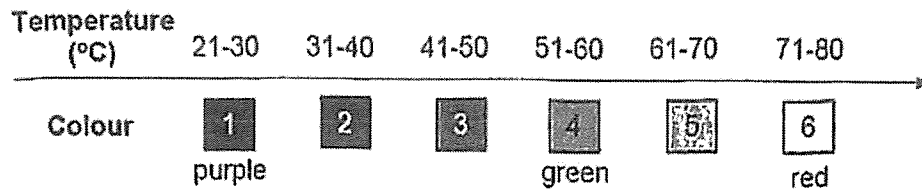

A metal bar was placed in a container of hot water at 80°C. When viewed through the heat camera, the following colours were observed on the metal bar immediately.

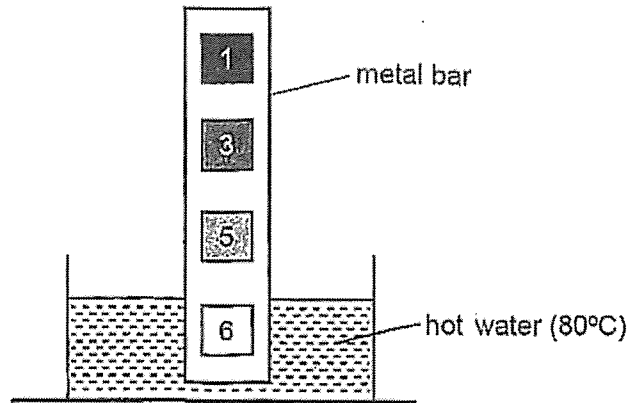

(a) Based on the diagram above, explain why different colours were observed on the metal bar. [2]

Question 37 continues next page

Two hours later, when viewed through the heat camera, only one colour was observed on the metal bar.

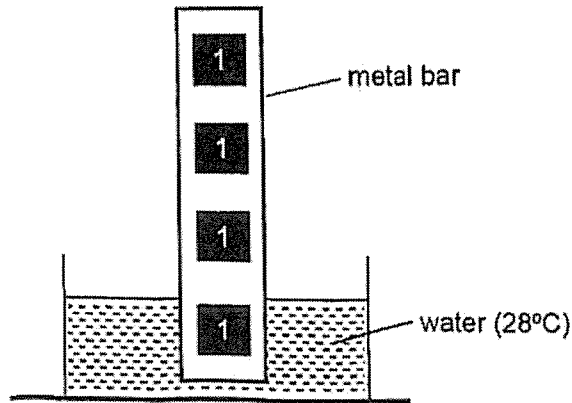

(b) Explain why only one colour was observed on the metal bar after two hours. [1]

The diagram below shows a lizard that lives in the desert. It runs across the hot sand by alternating two of its four legs on the hot sand.

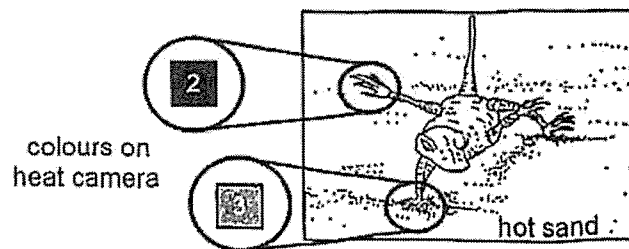

(c) When viewed through the heat camera, different colours were observed on the feet of the lizard as shown above. Explain why. [2]

Explanation	
Foot on the hot sand	
Foot above the hot sand	

(Go on to the next page)

SCORE	5
-------	---

- 38 Tammy designed the set-up below to catch crows. When the crow stands on the metal platform to eat the food, the iron door will be closed, trapping the crow.

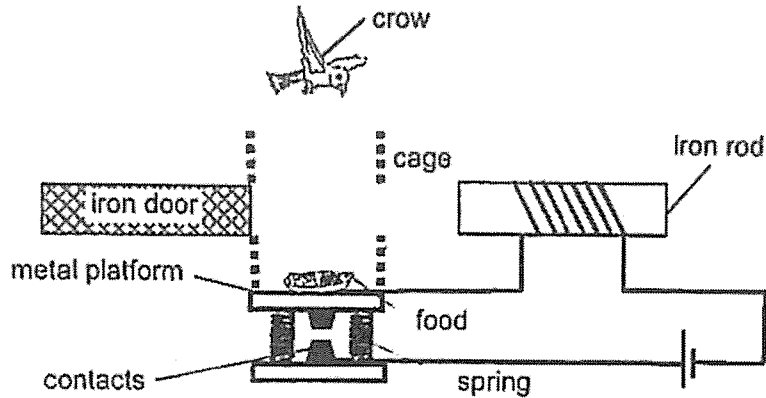

- (a) State a property of the contacts that allows the set-up to work properly. [1]

- (b) Describe and explain how the set-up works to catch the crow. [2]

- (c) Timmy observed that the set-up above will not work for lighter crows. Besides changing the spring, suggest an improvement he should make to his set-up such that the set-up could catch crows of a lighter mass. [1]

(Go on to the next page)

SCORE	4
-------	---

- 39 Ming Lee set up a device to count the number of drink bottles being thrown into a recycling box as shown below.

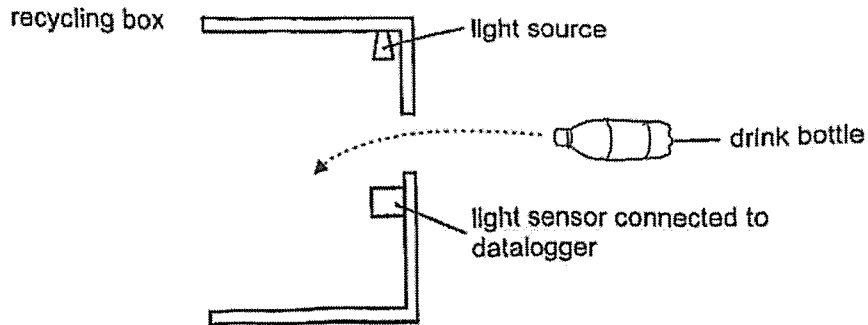

Drink bottles were thrown in one at a time. The datalogger recorded the following as shown in the graph below.

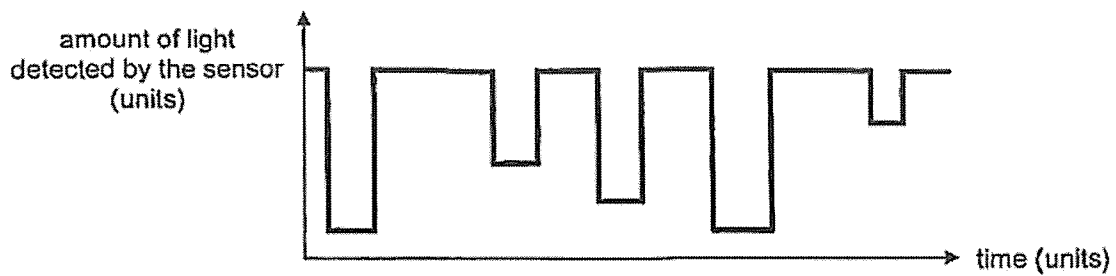

- (a) Based on the above result, how many drink bottles were thrown into the box? [1]

- (b) Explain why the graph shows a decrease in the amount of light detected by the light sensor at certain times. [1]

- (c) Give a reason why the decrease in the amount of light detected by the sensor did not reach zero. [1]

(Go on to the next page)

SCORE	3
-------	---

40 A dry mop was suspended above the floor using a holder as shown in the diagram below.

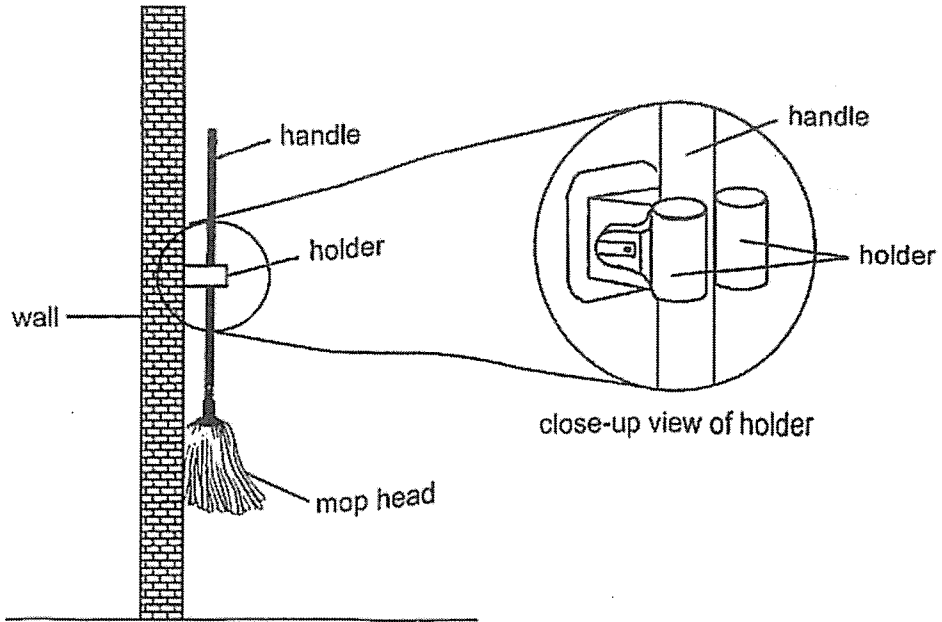

(a) Identify the force that prevents the mop from falling from the holder. [1]

(b) When the handle of the mop was wet, the mop kept falling from the holder. Give a reason for this observation. [1]

(c) After the mop was used to mop the floor, the mop head was dripping wet and the mop kept falling from the holder although the handle was dry. Explain why this was so in terms of forces. [2]

END OF PAPER

(Go on to the next page)

SCORE	4
-------	---

SCHOOL : SINGAPORE CHINESE GIRLS SCHOOL
LEVEL : PRIMARY 6
SUBJECT : SCIENCE
TERM : 2024 PRELIMINARY EXAMINATION

Section A

Q1	Q2	Q3	Q4	Q5	Q6	Q7	Q8	Q9	Q10
3	1	2	4	2	1	2	1	4	2
Q11	Q12	Q13	Q14	Q15	Q16	Q17	Q18	Q19	Q20
1	4	1	3	3	4	4	2	4	3
Q21	Q22	Q23	Q24	Q25	Q26	Q27	Q28		
1	1	2	4	3	2	1	3		

SINGAPORE CHINESE GIRLS' PRIMARY SCHOOL
2024 P6 PRELIMINARY EXAMINATION
MARK SCHEME (BOOKLET B)

Qn	Answer
29	<p>(a) </p> <p>(b) Y and W [½ mark each]</p> <p>(c) The <u>small indigestible seeds</u> are eaten together with the fruit and <u>passed out in the dropping/waste</u>, [½] <u>away from the parent plant to reduce / prevent overcrowding.</u> [½]</p>
30	<p><i>Key idea: Interdependence (mutualism) between organisms.</i></p> <p>(a) (i) P will have <u>a source of food</u> / R can <u>protect P</u> from its predators. [1] (ii) C will <u>not have pests/ less pests to feed on its blood / spread infections.</u> [1]</p> <p>(b) Animal C <u>loses heat to the water</u> [½] on its body as the <u>water evaporates.</u> [½]</p>
31	<p><i>Key idea: Recognise the function of organs of digestive system and how all the body systems work together</i></p> <p>(a) The digestive system <u>breaks down food into simpler substances / glucose / sugar</u> [½] which is <u>absorbed into the bloodstream.</u> [½] The circulatory system <u>transports blood rich in digested food to all parts of the body.</u> [1]</p> <p>(b) Digestion of food does not take place in the gullet. [1]</p> <p>(c) Food is being chewed less, resulting in the <u>bigger pieces of food</u> [½] having <u>less surface area in contact with the digestive juice</u> [½], leading to a lower rate of digestion</p>

32	<p><i>Key idea: life cycle; data inference skills</i></p> <p>(a) As the surrounding <u>temperature increases</u>, the length of one complete <u>life cycle shortens / decreases.</u> [1]</p> <p>(b) Between July and December <u>claim must be correct</u></p> <table border="1"> <thead> <tr> <th>Reason</th> <th>Cause [1/2]</th> <th>Effect [1/2]</th> </tr> </thead> <tbody> <tr> <td>Reason 1</td> <td>Higher amount of rainfall</td> <td>More places of mosquito to lay eggs / more rainfall allows more mosquitoes to lay eggs.</td> </tr> <tr> <td>Reason 2</td> <td>Higher temperature</td> <td>Duration of life cycle of mosquito is shorter.</td> </tr> </tbody> </table> <p>(c) The adult mosquitoes will get <u>stuck to / trapped by the sticky lining</u> [1/2 - observation] There will be <u>fewer mosquitoes to sting / transmit or spread disease D</u> [1/2 - inference]</p>	Reason	Cause [1/2]	Effect [1/2]	Reason 1	Higher amount of rainfall	More places of mosquito to lay eggs / more rainfall allows more mosquitoes to lay eggs.	Reason 2	Higher temperature	Duration of life cycle of mosquito is shorter.
Reason	Cause [1/2]	Effect [1/2]								
Reason 1	Higher amount of rainfall	More places of mosquito to lay eggs / more rainfall allows more mosquitoes to lay eggs.								
Reason 2	Higher temperature	Duration of life cycle of mosquito is shorter.								
33	<p><i>Key idea: State the requirements (water, light energy and carbon dioxide) for photosynthesis; investigate factors that affect rate of photosynthesis</i></p> <p>(a) </p> <p>In the presence of light, carbon dioxide, water [1/2] is taken in by plants to produce glucose/sugar/food and oxygen. [1/2]</p> <p>[changed and constant variable – 1m] <ul style="list-style-type: none"> Without changing the temperature of water, [1/2] vary the distance between the lamp and the water plant. [1/2] [measured variable – 1m] Count the number of bubbles produced per minute for each distance. </p>									
34	<p><i>Key idea: reproduction in animals; human impact on environment</i></p> <p>(a) Deforestation / burning of forests / Increase in the number of vehicles / Increase in the number of factories / burning of fuels [1/2] each</p>									

34b	Global warming causes the polar ice caps to melt, resulting in rising sea levels and flooding / causing the sand to be covered in sea water / covering the beaches.
34c	There will be fewer males to mate with females. Hence, fewer eggs will be hatched into young / lower rate of reproduction.
35a	There is carbon dioxide in exhaled air.
35b	Nitrogen
35c	As the number of passengers increase, more water vapour will be in the air inside the bus. More water vapour will condense on the cooler surface of the windows.
36a	Melting is the change of state from solid to liquid at a fixed temperature.
36b	Substance X lowers the melting point of ice.
36c	The piles of snow will melt faster, clearing the road for vehicles.
37a	The part of the metal bar that is in direct contact / nearer to the hot water gained more heat / gained heat faster. The part of the metal bar that is further away from the hot water gained less heat / gained heat slower.
37b	The metal bar lost heat to the surroundings and reached room temperature / the same temperature as the surroundings.
37c	Foot on the ground. The foot gained heat from the hot sand / heat from the hot sand is transferred to the lizard's leg. Foot above the ground. The foot lost heat to the surroundings / cools down to the temperature of surroundings.

38a	It is a conductor of electricity/ electrical conductor.
38b	When crow lands on the metal platform to eat the food, the spring will be compressed, causing the two contacts to touch to form a closed circuit. The iron rod will become an electromagnet, and the iron door will be attracted, closing the door to the cage.
38c	Increase the length of contacts/ Bring the metal contacts closer.
39a	5 / five
39b	Light from the light source was partially blocked from the light sensor when a drink bottle was thrown in.
39c	Some drink bottles were translucent/ allowed some light to pass through.
40a	Frictional force / friction between the handle of the mop and the holder.
40b	Water (on the handle) reduced the amount of friction between the handle and the holder.
40c	The mass of the mop increased/ the mop became heavier due to the water it absorbed. The weight of the mop / gravitational force acting on the mop is greater than the frictional force between the mop and the holder.