

**RAFFLES GIRLS' PRIMARY SCHOOL
END OF YEAR EXAMINATION 2025
MATHEMATICS
PRIMARY 3**

Name: _____ () Class: P3 _____

Date: 27th October 2025

Duration: 1 hour 30 minutes

Your Score	
Section A (15 marks)	
Section B (15 marks)	
Section C (20 marks)	
Total (50 marks)	
Parent's Signature	

INSTRUCTIONS TO CANDIDATES

1. Do not turn over this page until you are told to do so.
2. Follow all instructions carefully.
3. Answer **ALL** questions and show all working clearly.

SECTION A (15 marks)

Questions 1 to 5 carry 1 mark each. Questions 6 to 10 carry 2 marks each.
For each question, four options are given. One of them is the correct answer.
Make your choice (1, 2, 3 or 4) and shade your answer (1, 2, 3 or 4) on the
Optical Answer Sheet.

1. In 7685 the digit _____ is in the tens place.
 - (1) 5
 - (2) 6
 - (3) 7
 - (4) 8

2. Which of the following fractions is the simplest form of $\frac{6}{12}$?
 - (1) $\frac{1}{3}$
 - (2) $\frac{1}{2}$
 - (3) $\frac{3}{4}$
 - (4) $\frac{1}{6}$

3. Express 3320 g in kilograms and grams.
 - (1) 3 kg 2 g
 - (2) 3 kg 32 g
 - (3) 3 kg 320 g
 - (4) 33 kg 20 g

4. 2 hours = _____ minutes

- (1) 20
- (2) 60
- (3) 120
- (4) 200

5. Name the acute angle in the figure.

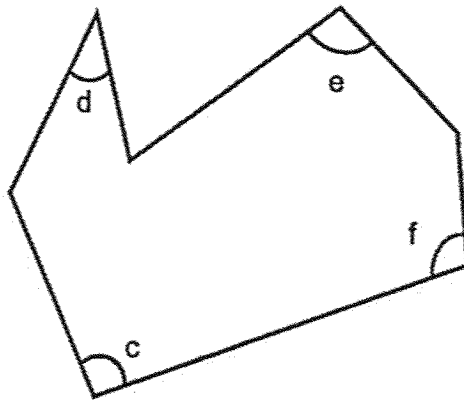

- (1) $\angle c$
- (2) $\angle d$
- (3) $\angle e$
- (4) $\angle f$

6. What is the missing number in the number pattern?

3680, 3830, 3730, 3880, _____, 3930, 3830

- (1) 3730
- (2) 3780
- (3) 3830
- (4) 4030



7. What is the missing number in the box?

$$\frac{2}{3} = \frac{6}{\square}$$

- (1) 6
- (2) 9
- (3) 12
- (4) 15

8. Sandy gave the cashier a \$10 note and received \$2.70 as change.

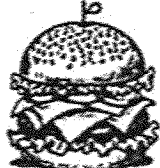
Which two items did she buy?

			
Salad	Burger	Fries	Drink
\$7.90	\$4.80	\$3.10	\$2.50

- (1) Burger and salad
- (2) Burger and drink
- (3) Fries and salad
- (4) Fries and drink

9. Jessie prepared 1500 ml of fruit juice. She filled 3 glasses with 200 ml of fruit juice each. How much fruit juice had she left?

- (1) 500 ml
- (2) 600 ml
- (3) 900 ml
- (4) 1300 ml

10. Which two shapes shown in the grid have the same area?

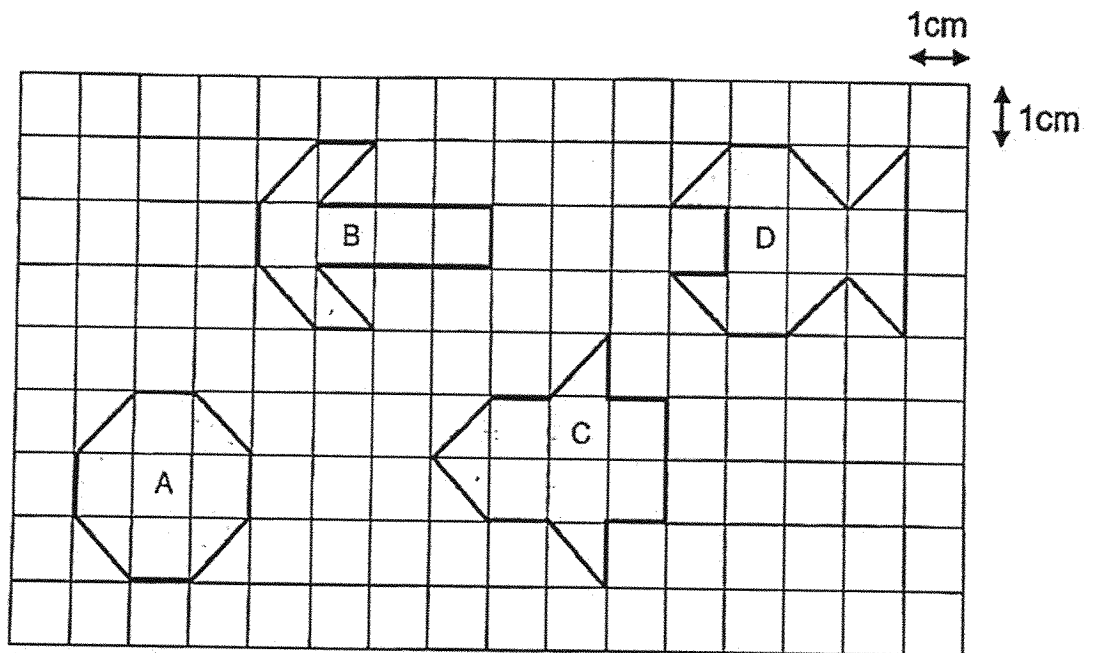

- (1) A and B
- (2) B and C
- (3) C and D
- (4) D and A

SECTION B (15 marks)

Questions 11 to 15 carry 1 mark each. Questions 16 to 20 carry 2 marks each. Show your working clearly and write your answers in the spaces provided. For questions which require units, give your answers in the unit stated.

11. Write 3649 in words.

Answer: _____

12. What is the missing number in the box?

$$2615 + \boxed{} = 8510$$

Answer: _____

13. What is the fraction represented by A on the number line?

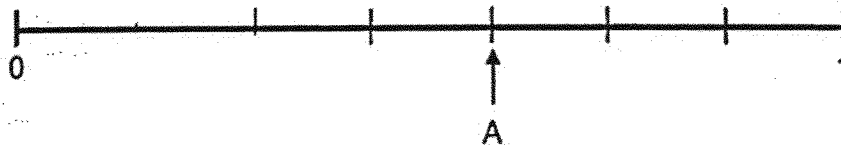

Answer: _____

14. Find the sum of $\frac{2}{4}$ and $\frac{3}{8}$

Answer: _____

15. Kelvin travels from his house by bus to buy breakfast at the coffeeshop. How far is the coffeeshop from his house?

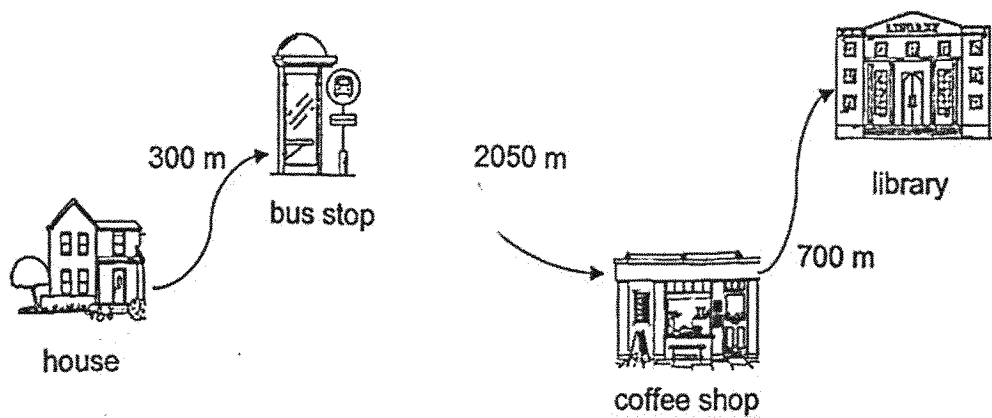

Answer: _____ m

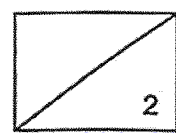

16. Identify a line parallel to line AB.

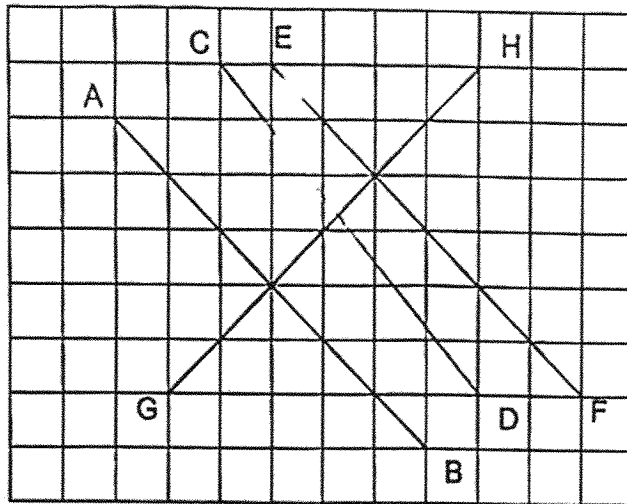

Answer: _____

17. The difference between two numbers is 2635. The greater number is 3569. What is the smaller number?

Answer: _____

18. Divide 968 by 6. What is the remainder?

Answer: Remainder is _____

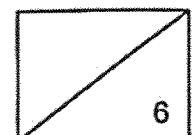

19. These figures are not drawn to scale.
Find the area and perimeter of each figure.
Make a comparison between the areas and perimeters of the figures.

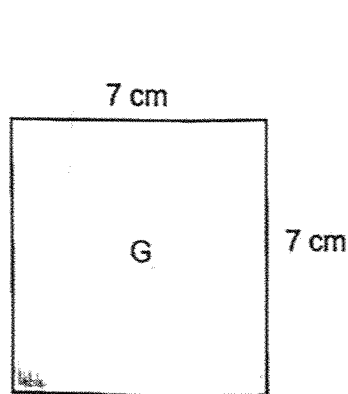

Area =
Perimeter =

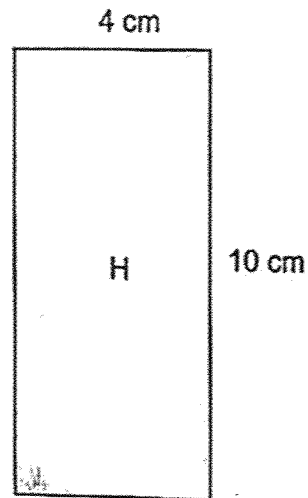

Area =
Perimeter =

Figure G and Figure H have the same _____ but different _____.

20. A kettle contains 900 ml of water. It contains 6 times as much water as a cup. A bottle contains 500 ml of water. How much more water does the bottle contain than the cup?

Answer: _____ ml



SECTION C (20 marks)

For questions 21 to 25, show your working clearly and write your answers in the spaces provided. The number of marks available is shown in brackets [] at the end of each question or part-question.

21. Mary read 137 pages of her book on the first day. She read 34 fewer pages on the second day.

(a) How many pages did Mary read on the second day?

Answer: (a) _____ [2]

(b) There were 424 pages in the book. Mary completed reading the book on the third day. How many pages did she read on the third day?

Answer: (b) _____ [2]

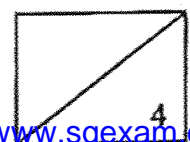

22. Doughnuts are sold at the price shown.

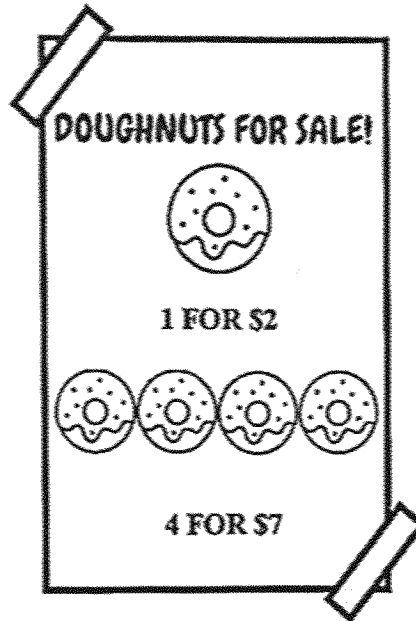

(a) Mei Ling bought 3 doughnuts. How much did she pay?

Answer: (a) _____ [1]

(b) Raja bought 9 doughnuts. What was the least amount of money he paid?

Answer: (b) _____ [3]

23. Michelle arrived at the cinema at 3:15 p.m. She waited for 25 minutes for the movie to start. The movie ended at 6 p.m.
(Draw a timeline to show your working.)

(a) How long was the movie?

Answer: (a) _____ [2]

(b) She took a bus home after the movie. The bus ride took 35 minutes. She reached home at 7:25 p.m. What time did she board the bus?

Answer: (b) _____ [2]

24. The bar graph shows the number of items a charity collected over 4 days.

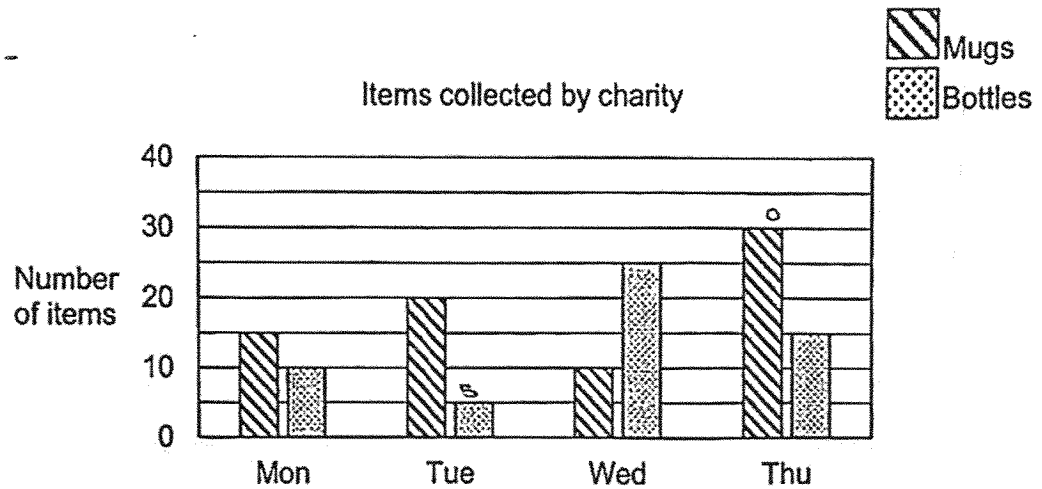

- (a) 5 more mugs than bottles were collected on _____. [1]
- (b) There were _____ fewer bottles collected on Tuesday than on Wednesday. [1]
- (c) The total number of items collected on Thursday was _____. [1]
- (d) The total number of mugs collected over the 4 days was _____. [1]

25. Jane bought 112 pens for a party. She packed them equally into 8 boxes.

(a) How many pens were there in each box?

Answer: (a) _____ [1]

(b) The 112 pens were a mix of blue, red and green. There were twice as many blue pens as red pens. There were 8 more green pens than red pens. How many red pens were there?

Answer: (b) _____ [3]

-End of Paper-
Please check your work carefully ☺

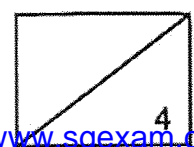

SCHOOL : RAFFLES GIRLS' PRIMARY SCHOOL
LEVEL : PRIMARY 3
SUBJECT : MATHEMATICS
TERM : 2025 END OF YEAR EXAMINATION

Q1	Q2	Q3	Q4	Q5	Q6	Q7	Q8	Q9	Q10
4	2	3	3	2	2	2	2	3	3

Q11	Three thousand six hundred and forty-nine
Q12	$8510 - 2615 = 5895$
Q13	$\frac{4}{7}$
Q14	$\frac{2}{4} + \frac{3}{8} = \frac{4}{8} + \frac{3}{8} = \frac{7}{8}$
Q15	$300\text{m} + 2050\text{m} = 2350\text{m}$
Q16	EF
Q17	$3569 - 2635 = 934$
Q18	$968 \div 6 = 161 \text{ R}2$
Q19	Area (G) $7 \times 7 = 49$ Perimeter (G) = $7 + 7 + 7 + 7 = 28\text{cm}$ Area (H) $4 \times 10 = 40$ Perimeter (H) = $4 + 10 + 4 + 10 = 28\text{cm}$ Same Perimeter but different areas
Q20	$900 \div 6 = 150\text{ml}$ $500 - 150 = 350\text{ml}$
Q21	a) $137 - 34 = 103$ b) $137 + 103 = 240$ $424 - 240 = 184$
Q22	a) $3 \times \$2 = \6 b) $\$7 + \$7 + \$2 = \16
Q23	a) 2 hr 30mins b) 6.50pm
Q24	a) Monday b) 20 c) 45 d) 75

Q25

a) $112 \div 8 = 14$

b) $112 - 8 = 104$

$104 \div 4 = 26$

www.sgexam.com