



RAFFLES GIRLS' PRIMARY SCHOOL  
END-OF-YEAR EXAMINATION  
PRIMARY THREE  
2025

SCIENCE  
(BOOKLET A)

Name: \_\_\_\_\_ ( )

Date : 28 October 2025

Class: P3 \_\_\_\_\_

Total Time: 1h 30min

INSTRUCTIONS TO CANDIDATES

1. Write your name, class and index number in the spaces provided above.
2. Do not turn over this page until you are told to do so.
3. Follow all instructions carefully.
4. Answer all questions.
5. For Question 1 – 25, use 2B pencil to shade your answers on the Optical Answer Sheet (OAS).

Booklet A	50
Booklet B	30
Your score out of 80	
Parent's signature	

1. Study the diagram.

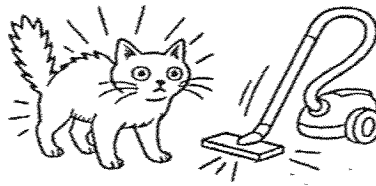

Based on the diagram, which of the following best represents the characteristic of living things demonstrated by the cat?

- (1) Living things grow.
- (2) Living things reproduce.
- (3) Living things respond to changes around them.
- (4) Living things need air, food and water to survive.

2. The graph shows the height of a plant over five months.

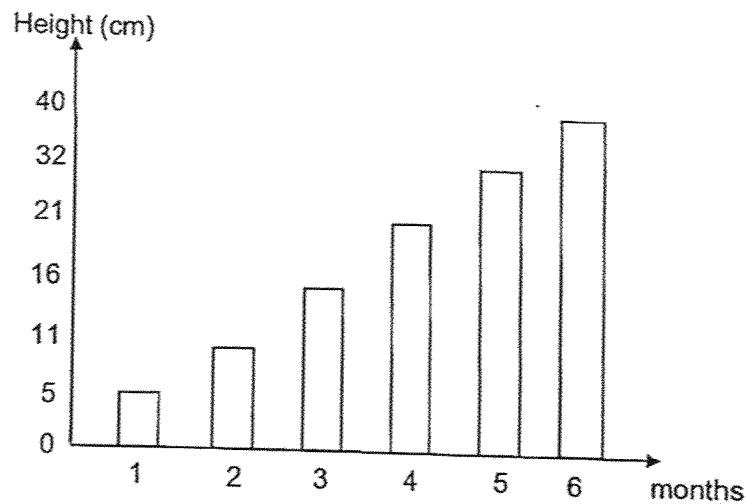

Based on the information, what can be concluded about the plant?

- (1) The plant bears fruits as it grew.
- (2) The plant needed less sunlight as it grew
- (3) The height of the plant increased as it grew.
- (4) The mass of the plant remained the same as it grew.

3. Joe classified some animals he observed into two groups, P and Q.

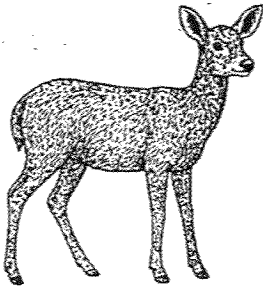
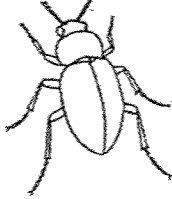
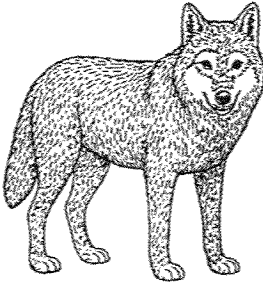
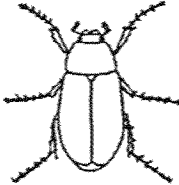
Animals	
P	Q
	
	

Based on his observation only, which characteristics did Joe use to classify the animals in groups P and Q?

	P	Q
(1)	Four legs	Six legs
(2)	Two feelers	No feelers
(3)	One body part	Three body parts
(4)	Has outer covering of fur	Has outer covering of scales

4. Which of the following statements correctly describes an amphibian?

- (1) It has scales.
- (2) It can only live in water.
- (3) It gives birth to its young alive.
- (4) It breathes through their skin underwater.

5. Study the diagram carefully.

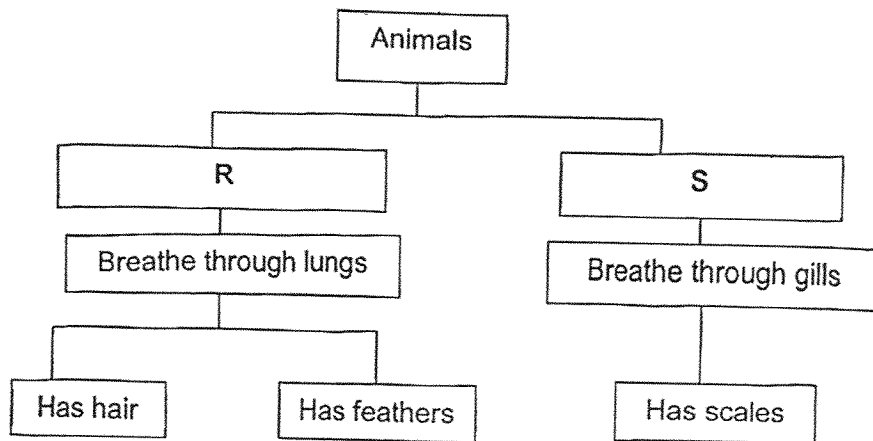

Which of the following could be the headings for R and S?

	R	S
(1)	Mammals	Fish
(2)	Amphibians	Reptiles
(3)	Lay eggs	Give birth to young alive
(4)	Live on land	Live in water

6. Study the following flow chart.

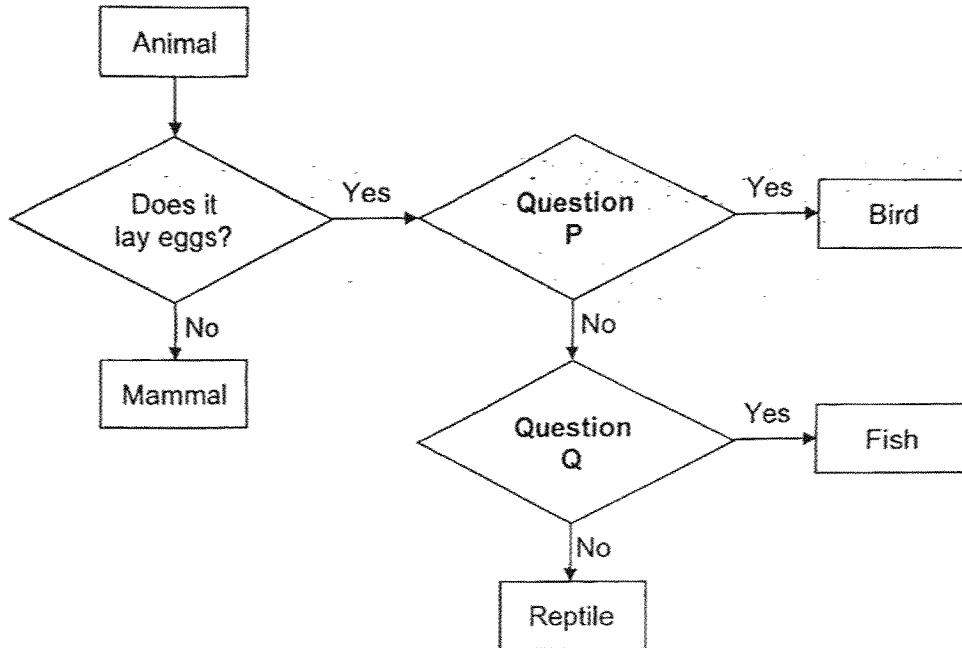

Which of the following best represent questions P and Q?

	Question P	Question Q
(1)	Does it have wings?	Is it covered with feathers?
(2)	Does it breathe through gills?	Is it covered with feathers?
(3)	Does it have wings?	Does it breathe through gills?
(4)	Does it breathe through gills?	Does it have wings?

7. Study the plants A and B shown in the diagrams.

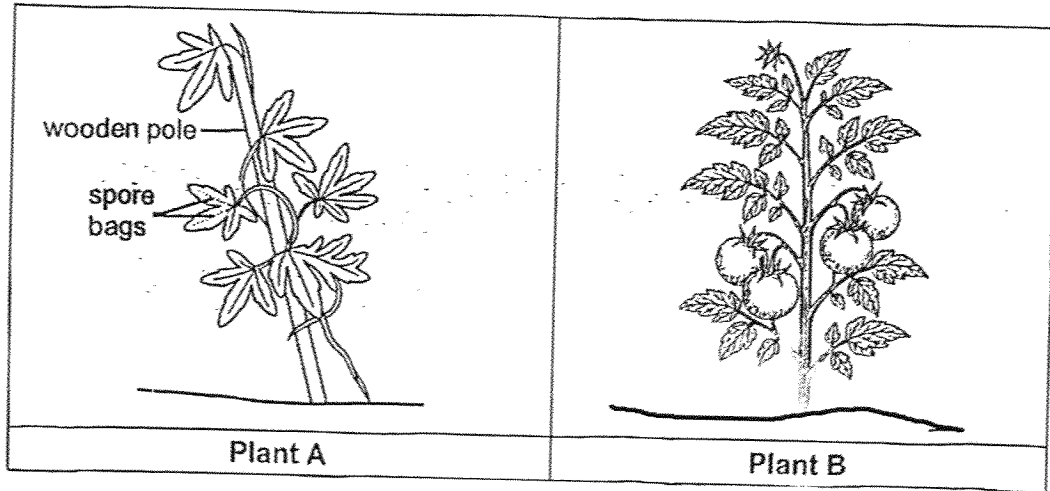

Based on the information above, which letters, W, X, Y or Z, best represent plants A and B respectively?

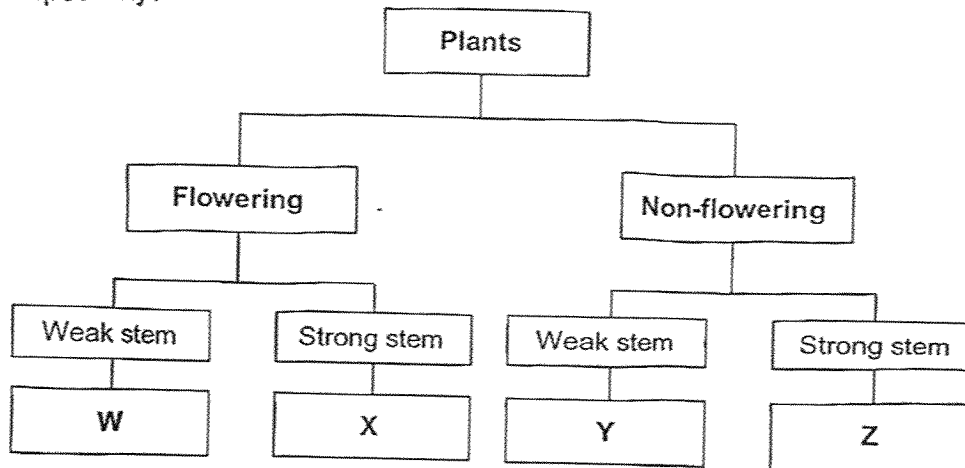

	Plant A	Plant B
(1)	X	Z
(2)	Y	W
(3)	Y	X
(4)	Z	W

8. Zoe has four plants, E, F, G and H, with characteristics as shown in the table below.

Characteristic	Plant			
	E	F	G	H
Grows on land	✓	✓		
Reproduces by spores		✓		✓
Bears fruit	✓		✓	

Based on the information above, Zoe classified her plants as shown below.

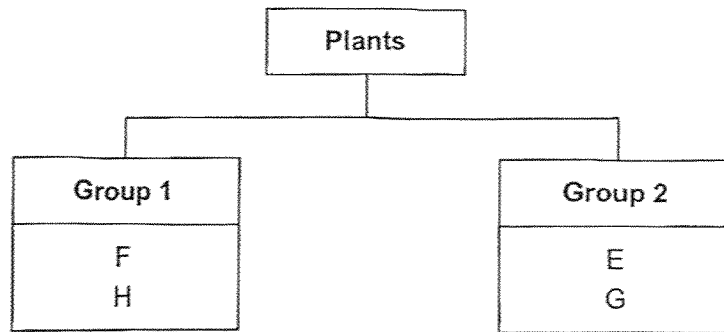

Which of the following sub-headings for groups 1 and 2 are correct?

	Group 1	Group 2
(1)	Ferns	Fungi
(2)	Fungi	Non-flowering
(3)	Lives on land	Lives on water
(4)	Non-flowering	Flowering

9. Which of the following statements describe the similarity between the mushroom and the bacteria?

- (1) They are micro-organisms.
- (2) They need water to survive.
- (3) They can make their own food.
- (4) They do not need air to survive.

10. Which of the following stage is not found in the life cycle of a mealworm beetle?

- (1) Egg
- (2) Pupa
- (3) Larva
- (4) Nymph

11. The diagrams show the life cycles of animals P and Q.

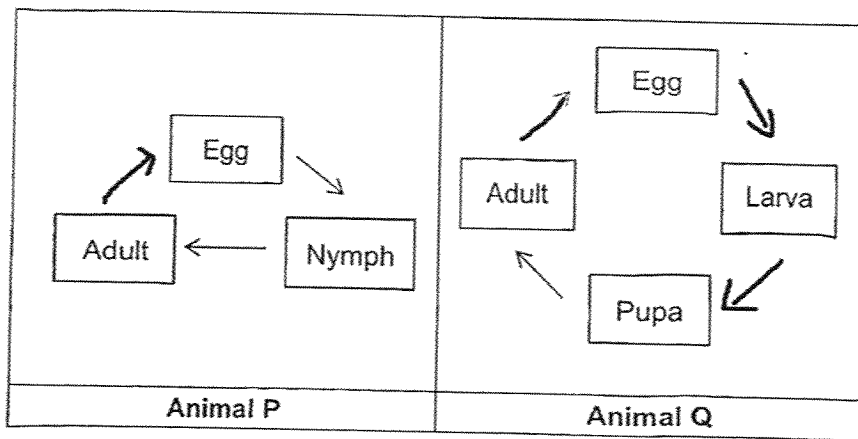

Which of the following most likely represents P and Q correctly?

	Animal P	Animal Q
(1)	Mosquito	Grasshopper
(2)	Cockroach	Butterfly
(3)	Butterfly	Mosquito
(4)	Grasshopper	Cockroach

12. The diagrams show the life cycles of animals X and Y.

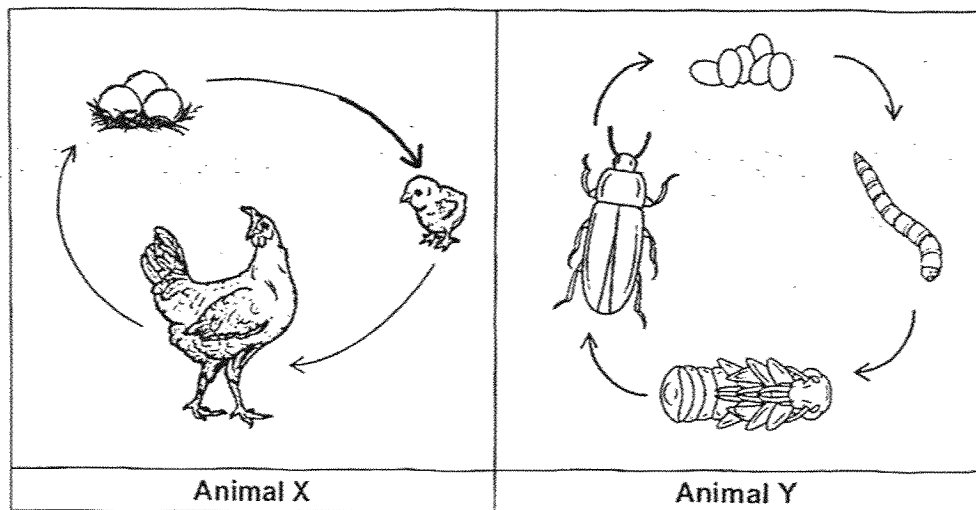

Based on the information, which of the following statements is true about the life cycles?

- (1) Animal X has more stages in its life cycle than animal Y.
- (2) Animal X gives birth to its young alive but not animal Y.
- (3) Animal Y has a larval stage in its life cycle but not animal X.
- (4) Animal Y has a young that looks like the adult but not animal X.

13. Which of the following diagrams show the correct life cycle of a plant?

(1)

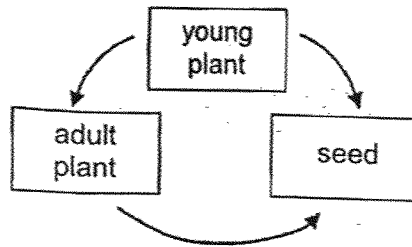

(2)

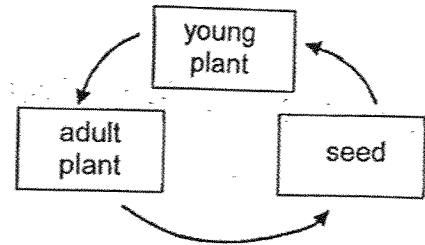

(3)

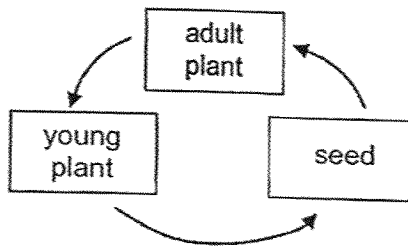

(4)

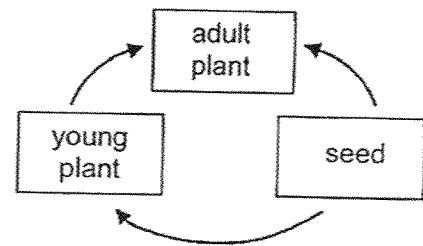

14. The diagrams show the different stages of the development of a plant. The stages are not in the correct order.

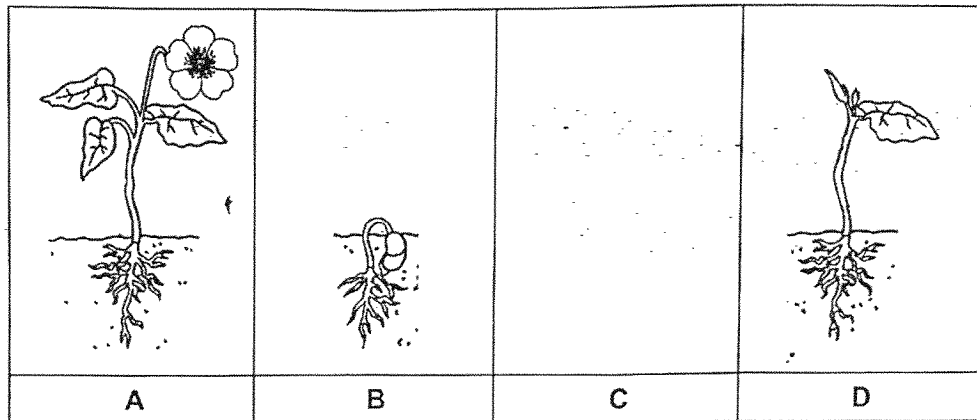

At which stage(s) can the plant bear fruits?

- (1) A only
- (2) D only
- (3) A and D only
- (4) B and C only

15. Judy observed the growth of a plant over stages A, B, C and D.

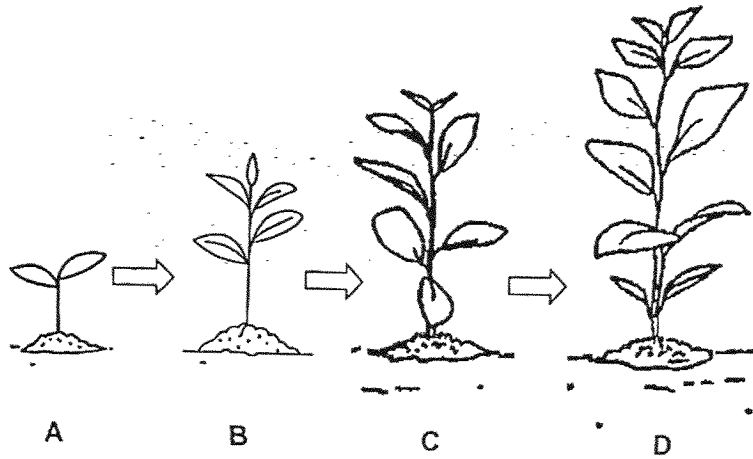

Which of the following graphs shows her observation correctly?

(1)

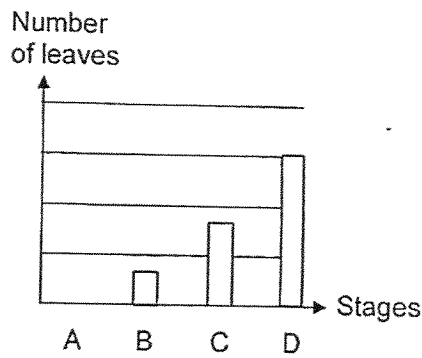

(2)

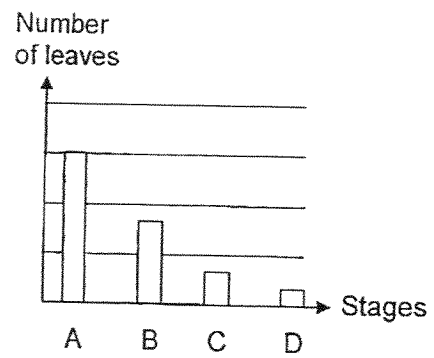

(3)

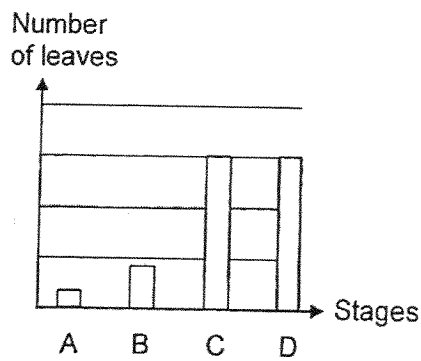

(4)

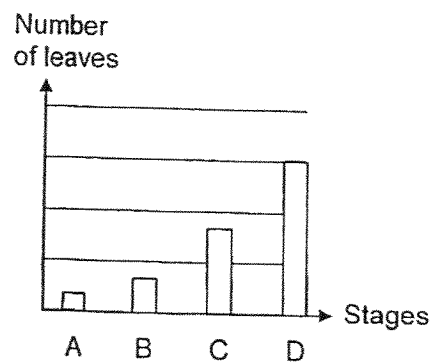

16. Henry wanted to choose a material to make part X of his display cabinet doors to allow him to see his trophies.

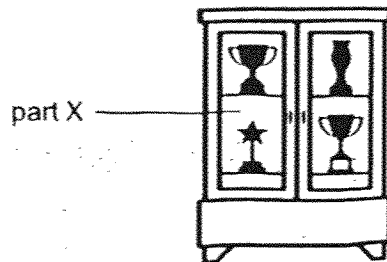

Which of the following properties is most important to take into consideration when choosing the material to make part X?

- (1) Strength
  - (2) Flexibility
  - (3) Waterproof
  - (4) Transparency
17. Raj dropped four similar objects, A, B, C and D, made of different materials into a container as shown below.

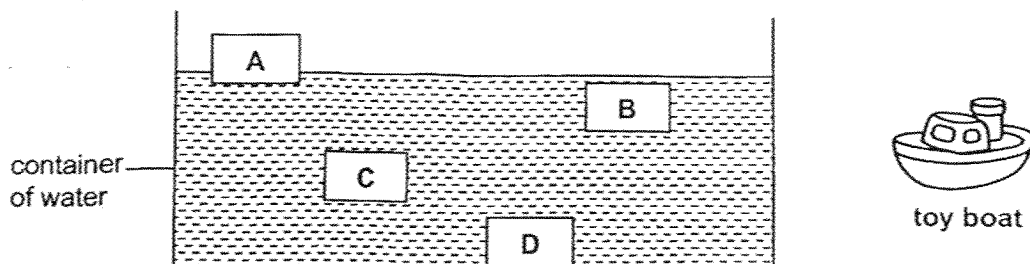

Which material, A, B, C or D, should be used to make the toy boat so it can be played in a bath tub?

- (1) A
- (2) B
- (3) C
- (4) D

18. Jim wore a pair of sunglasses outdoors as its lenses help to reduce the amount of light entering the eyes.

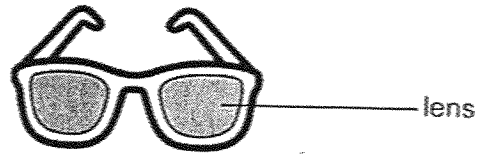

The table below shows the amount of light from a torch passing through lenses L, M, N and O. The amount of light from the torch is 100 unit.

Lens	Amount of light that passed through the lens (unit)
L	97
M	45
N	0
O	60

Which of the lens(es) is/are most likely to be suitable to make the lenses of Jim's sunglasses?

- (1) L only
- (2) N only
- (3) M and O only
- (4) L, M and O only

19. Ahmad carried out an experiment using different materials, P, Q, R and S. He attached a 4kg-mass to each strip of material and measured the distance it bent,  $d$ , as shown in the diagram.

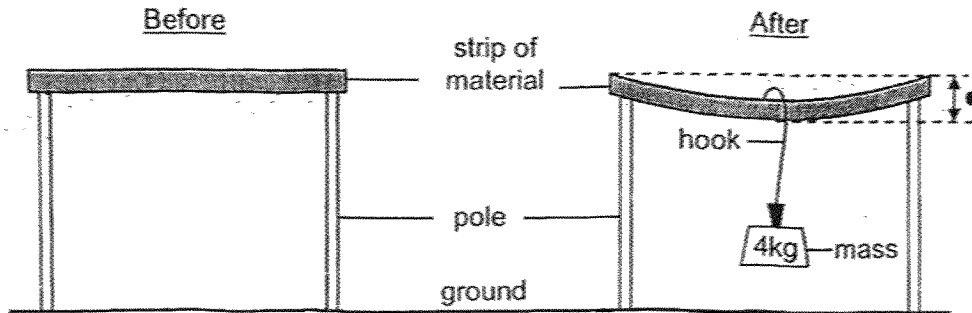

He recorded his results in the graph below.

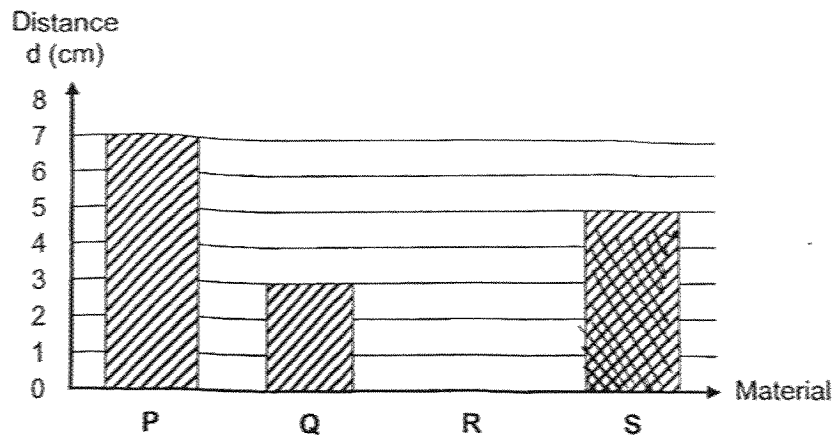

Which material, P, Q, R or S, is most suitable to be made into a key?

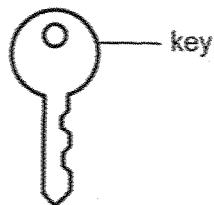

- (1) P
- (2) Q
- (3) R
- (4) S

20. Which of the following does **not** demagnetise a magnet?

- (1) Heat the magnet using a fire.
- (2) Stroke the magnet with a silver bar.
- (3) Hit the magnet with a hammer several times.
- (4) Drop the magnet from a height several times.

21. The diagram below shows three rings, P, Q and R, placed freely on a wooden rod. There are two ring magnets and one plastic ring.

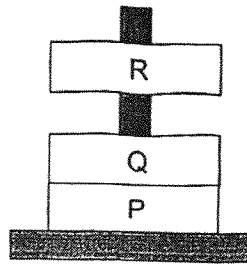

Based on the information above, which of the following statement(s) is/are correct?

- A Like poles of rings Q and R are facing each other.
- B Unlike poles of rings P and Q are facing each other.
- C Rings Q and P are magnets, while ring R is a plastic ring.

- (1) A only
- (2) B only
- (3) A and B only
- (4) A and C only

22. A plastic bowl is filled with water. A magnet is attached to a piece of wood which floats freely on the water as shown in the diagram.

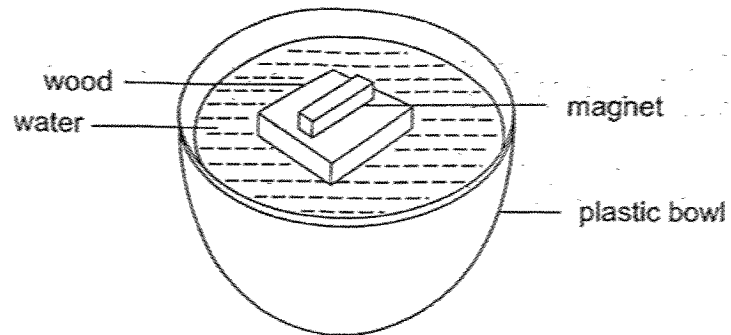

After some time, the magnet will come to rest pointing in the \_\_\_\_\_ direction.

- (1) East-West
- (2) South-East
- (3) North-West
- (4) North-South

23. Study the diagrams.

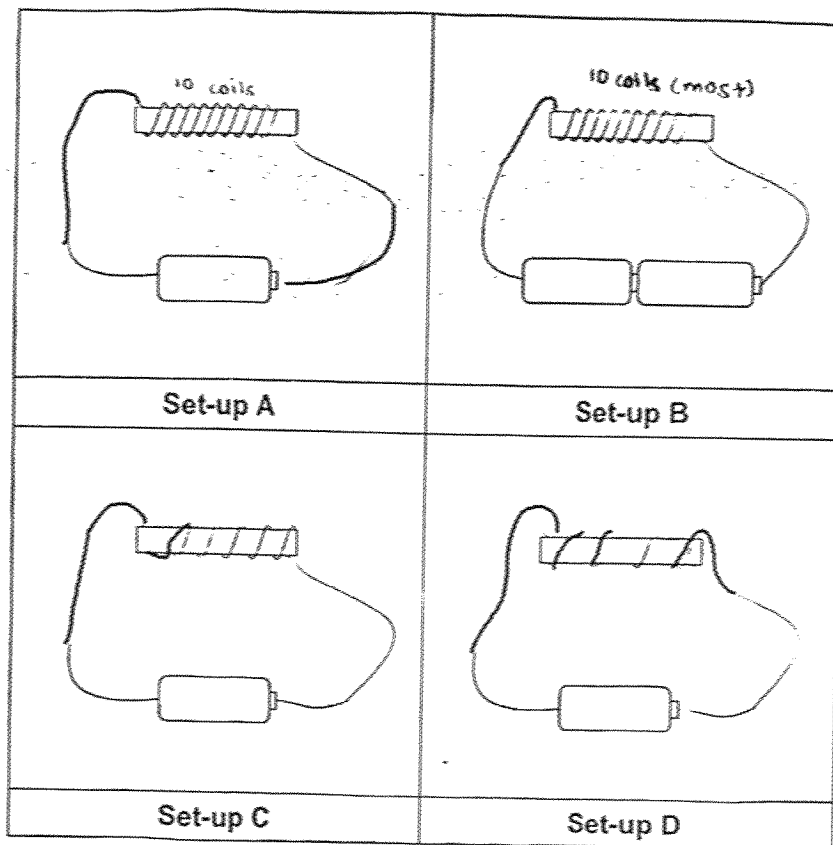

Which of the following shows the correct arrangement of the electromagnets according to their magnetic strengths starting from the weakest to the strongest?

	Weakest → Strongest			
(1)	B	A	C	D
(2)	C	D	A	B
(3)	D	C	A	B
(4)	D	C	B	A

24. Ai Ting stroked a steel nail with a magnet as shown in the diagram. She placed a compass near to one end of the magnetised nail and made an observation.

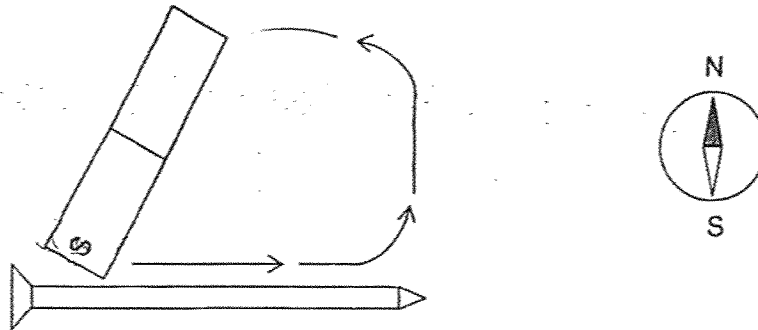

Which of the following is the correct observation?

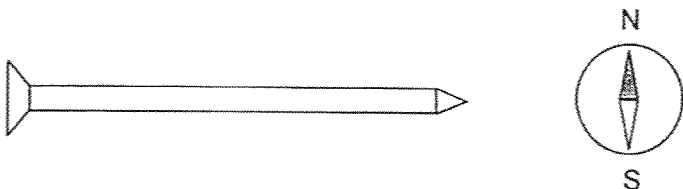
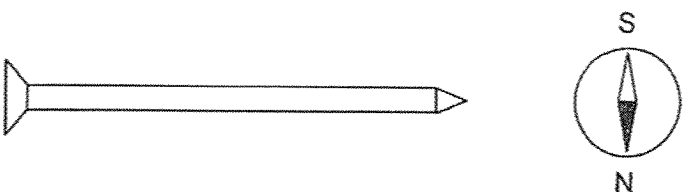
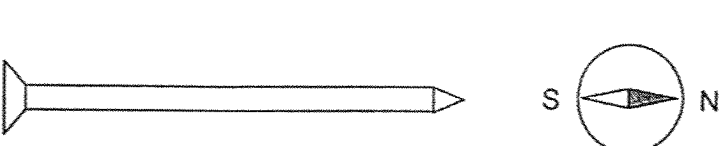
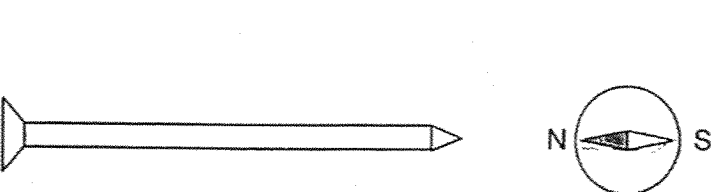
- (1)  (2) 
- (3)  (4) 
- Options (1) and (2) show a nail with a compass needle pointing North-South. Option (3) shows a nail with a compass needle pointing South-North. Option (4) shows a nail with a compass needle pointing North-South.

25. The arrows in the diagrams show the direction in which the bars moved when they were brought close to each other.

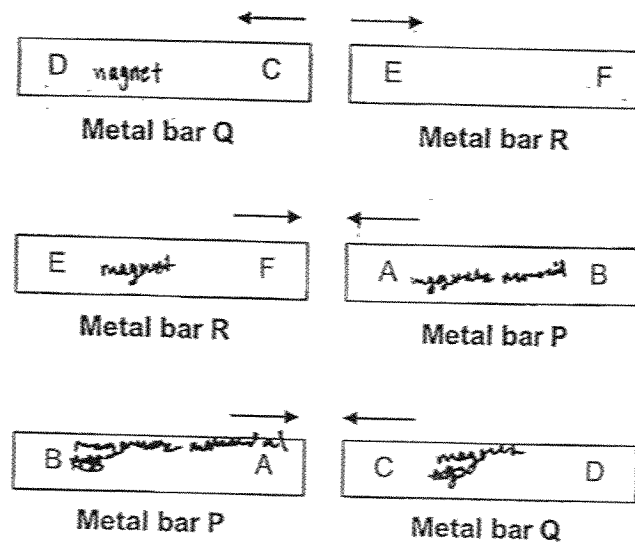

The diagram below shows a doorstop which is used to hold the door open.

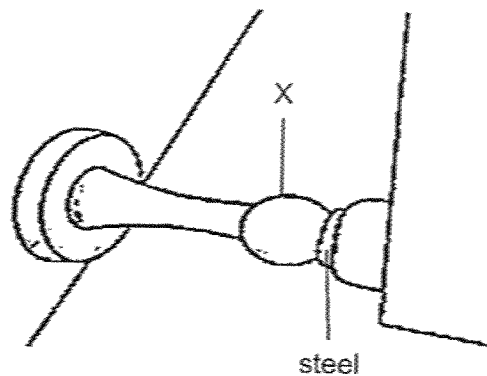

Which metal bar(s), P, Q and R can be used to make the part X?

- (1) P only
- (2) P and Q only
- (3) Q and R only
- (4) P, Q and R

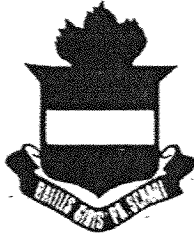

**RAFFLES GIRLS' PRIMARY SCHOOL  
END-OF-YEAR EXAMINATION  
PRIMARY THREE  
2025**

**SCIENCE  
(BOOKLET B)**

Name: \_\_\_\_\_ ( )

Date : 28 October 2025

Class: P3 \_\_\_\_\_

Total Time : 1h 30min

**INSTRUCTIONS TO CANDIDATES**

1. Write your name, class and index number in the spaces provided above.
2. Do not turn over this page until you are told to do so.
3. Follow all instructions carefully.
4. Answer all questions.
5. For questions 26 – 36, write your answers clearly in the spaces provided.
6. The number of marks is shown in brackets[ ] at the end of each question or part question.

Score	30
-------	----

26. Helen classified the animals below according to their outer covering.

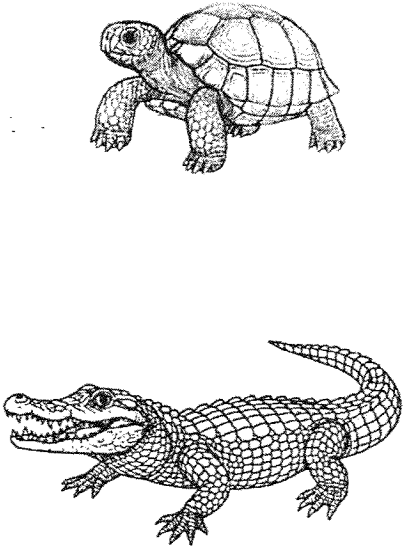
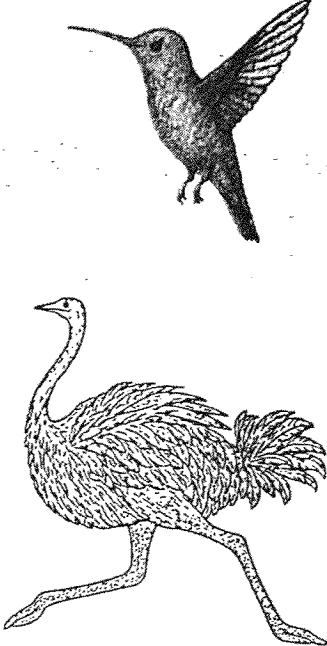
Group A	Group B
	

Based on the information above, answer the following questions.

(a) Name the outer covering of the animals in: [1]

(i) Group A: \_\_\_\_\_

(ii) Group B: \_\_\_\_\_

(b) Suggest another suitable heading for the groups above. [1]

(i) Group A: \_\_\_\_\_

(ii) Group B: \_\_\_\_\_

Score	2
-------	---

27. Based on the characteristics of living things, state whether the following statements are 'True' or 'False'.

Put a tick (✓) in the correct column.

[2]

	Statement	True	False
(a)	All living things can grow and die.		
(b)	Not all living things can reproduce.		
(c)	Anything which can move is a living thing.		
(d)	All living things need air, food and water to survive.		

Score	2
-------	---

P3 Science EYE 2025

28. Study the flowchart.

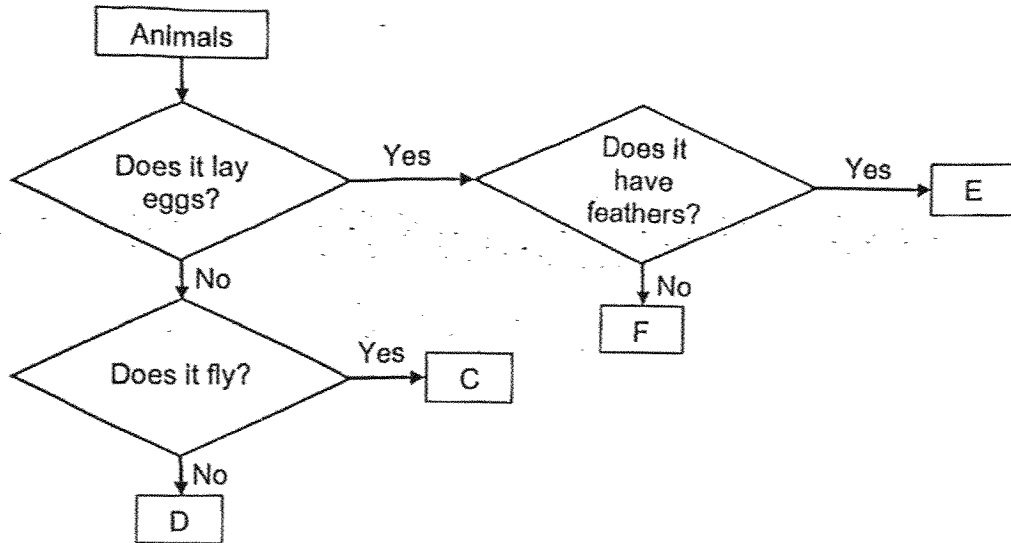

Based on the above information, answer the following questions.





(a) State one difference between animals D and F. [1]

---

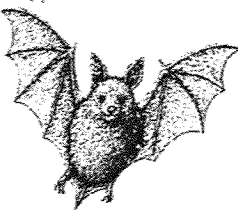

---

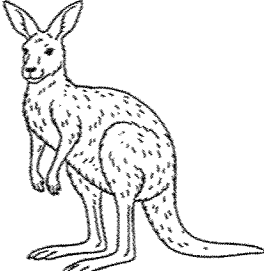
(b) The table shows four animals. Fill in the boxes below with the correct letter, C, D, E or F. [2]

			
<input style="width: 50px; height: 30px;" type="text"/>	<input style="width: 50px; height: 30px;" type="text"/>	<input style="width: 50px; height: 30px;" type="text"/>	<input style="width: 50px; height: 30px;" type="text"/>

Score	3
-------	---



30. The diagrams below show the different stages, L, M and N, in the life cycle of a frog.

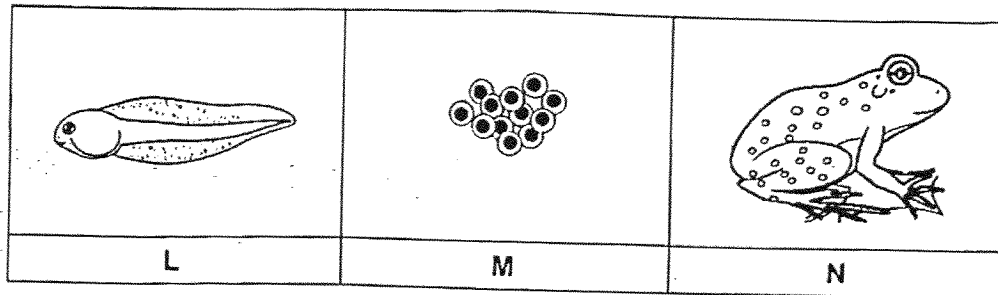

- (a) Fill in the letters, L or N into the correct boxes to show the stages of the life cycle of the frog. [1]

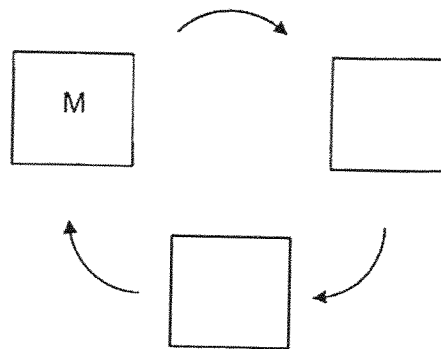

- (b) At which stage(s), L, M or N, in the life cycle do(es) the animal lives on both land and in water? [1]

\_\_\_\_\_

Score	2
-------	---

P3 Science EYE 2025

31. Annie observed a mosquito at each stage of its life cycle. She recorded her observations in the graph shown.

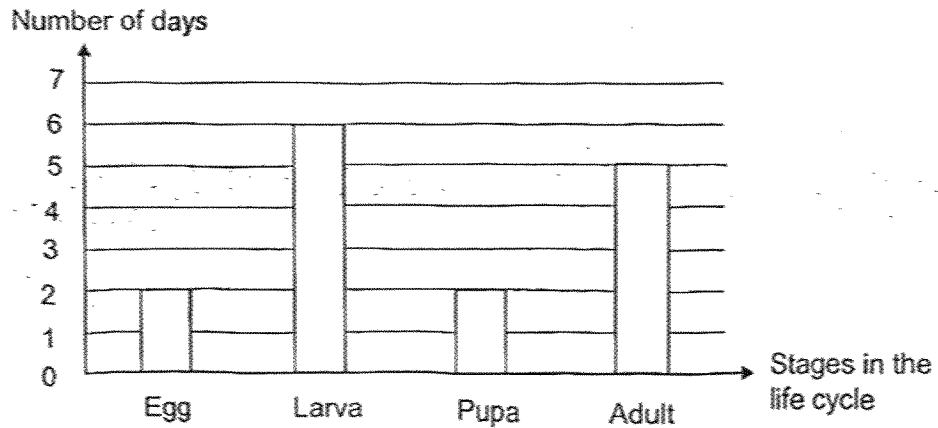

- (a) Based on her observations, how many days does it take for the mosquito to turn into an adult after it has hatched? [1]

The mosquito larvae take in surrounding air through their breathing tubes as shown in diagram 1. Annie poured a layer of oil, which floats on the water, into a beaker of water as shown in diagram 2.

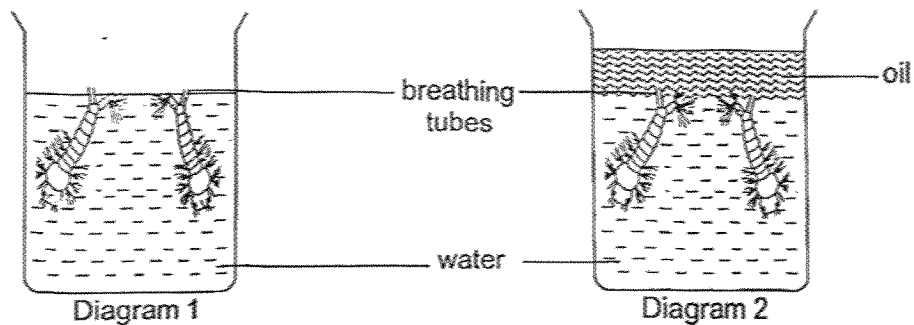

- (b) Explain why the layer of oil would kill mosquito larvae when it is added into the stagnant water. [2]

---



---



---

Score	3
-------	---

32. Read the following statements. Fill in the blanks with the numbers 1, 2, 3 and 4 to show the sequence of the development of a plant. [2]

Statements	Number
The plant starts to flower.	
The seed is put into the soil.	
The seed starts to grow the roots.	
The seed starts to grow the shoot.	

33. Mr Ravi prepared three set-ups, A, B and C, in the same room as shown in the diagram.

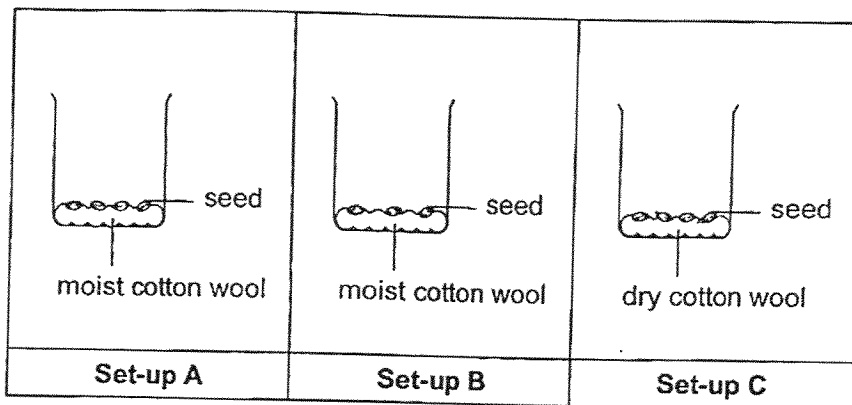

- (a) Mr Ravi wanted to find out if water is needed for seeds to germinate.

Which two set-ups, A, B and C, should he use to make sure that there is only one changed variable? [1]

Set-up: \_\_\_\_\_ and Set-up: \_\_\_\_\_

- (b) In which set-up(s), would germination occur after a few days? Explain why. [2]

---



---

Score	5
-------	---

P3 Science EYE 2025

34. Materials W, X, Y and Z are classified in the table below. A tick (✓) shows the presence of the properties.

Material	Properties	
	Is it strong?	Is it transparent?
W		
X		
Y		
Z		

- (a) Based on the table above, state the property of material X. [1]

---



---

The diagram below shows a sky-high observation capsule where visitors can enjoy the city view surrounding them and below their feet safely.

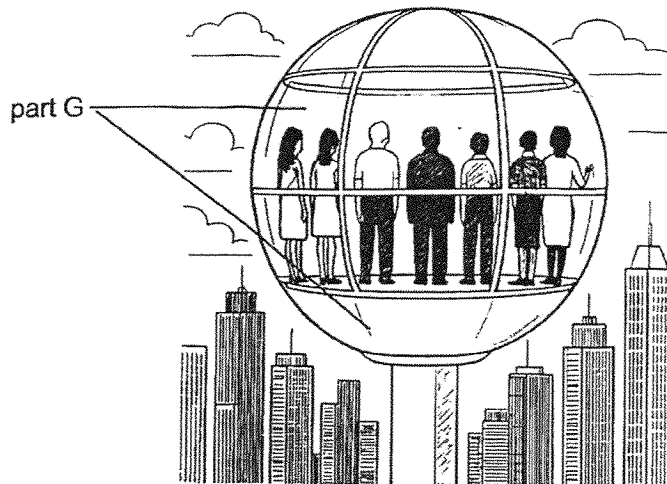

- (b) It was suggested to use material X to make part G of the capsule to allow them to enjoy the city view safely. Do you agree? Explain your answer. [2]

---



---

Score	3
-------	---

35. Sally conducted an experiment to find out how well each material, P, Q, R and S, can absorb water.

Each material was identical in size, length and thickness. She dipped one end of each material into a container of coloured water.

At the end of the experiment, the height of the water level on each material was observed as shown below.

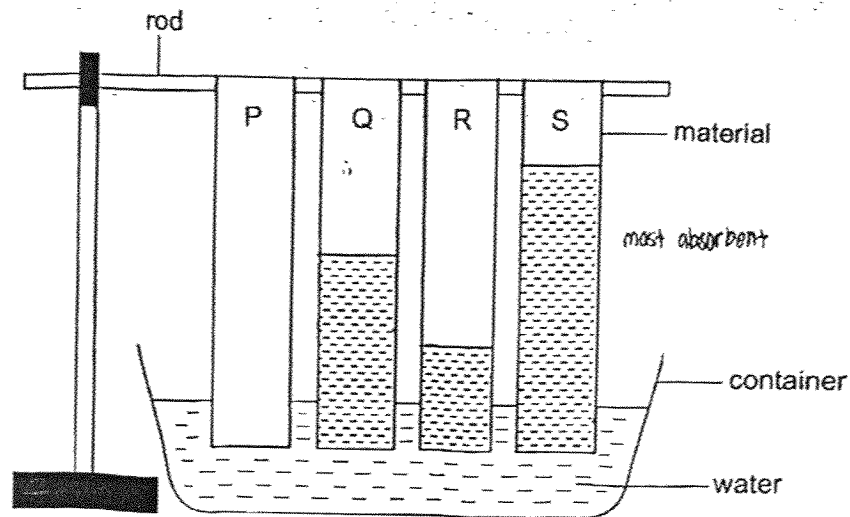

- (a) Arrange and write down the materials, P, Q, R or S, in the box, starting from the non-absorbent to the most absorbent material. [1]

Non-absorbent  $\longrightarrow$  Most absorbent

--	--	--	--

Continue on page 29

Score	1
-------	---

Continued from page 28

The diagram below shows a mop.

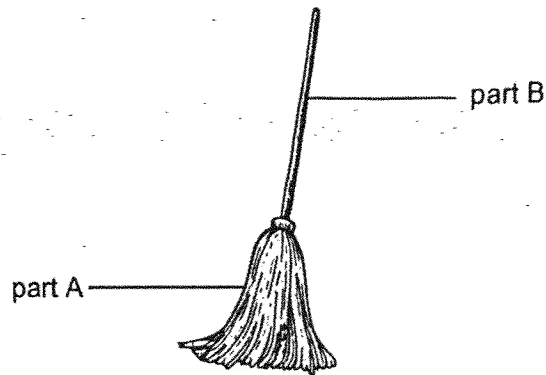

- (b) Using the information from your answer in part (a), which material, P, Q, R or S, is most suitable to make part A of a mop?

Give a reason for your answer.

[2]

---

---

Score	2
-------	---

36. Mrs Gopal wanted to find out if the type of metal rod affects the strength of an electromagnet. She set up the experiment using metal rods, W, X, Y and Z separately as shown in the diagram.

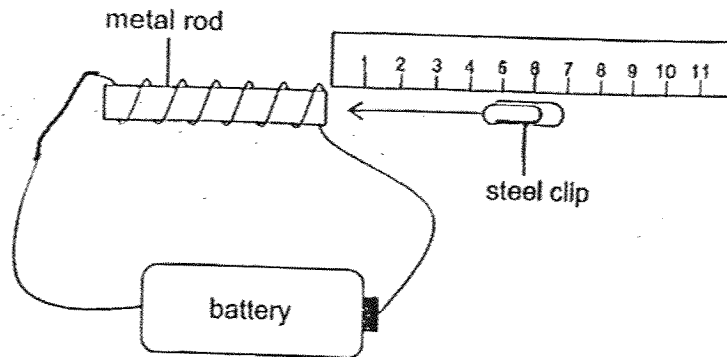

Mrs Gopal observed that the steel clip would start to be attracted by different types of metal rods at different distances. She recorded the distances in the table below.

Metal rod	Distance at which the steel clip would be attracted by the metal rods (cm)
W	8
X	6
Y	4
Z	-

Mrs Gopal observed that there was no interaction between the set-up and the steel clip when rod Z was used.

- (a) Put a tick (✓) next to the material(s) that was used to make metal rod Z. [1]

Material	Metal rod Z
Iron	
Nickel	
Copper	
Cobalt	

Continue on page 31

Score	1
-------	---

Continued from page 30

- (b) State a reason for your answer in part (a). [1]

---

---

Mrs Gopal wants to make an electromagnet to pick up as many steel nails as possible as shown in the diagram.

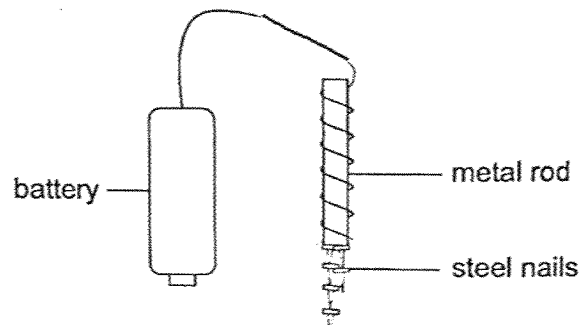

- (c) Which metal rod, W, X, Y or Z, should she use? Explain why. [2]

---

---

---

End of Paper

Score	3
-------	---

P3 Science EYE 2025



**SCHOOL : RAFFLES GIRLS' PRIMARY SCHOOL**  
**LEVEL : PRIMARY 3**  
**SUBJECT : SCIENCE**  
**TERM : 2025 END OF YEAR EXAMINATION**

Q1	Q2	Q3	Q4	Q5	Q6	Q7	Q8	Q9	Q10
3	3	1	4	4	3	3	4	2	4
Q11	Q12	Q13	Q14	Q15	Q16	Q17	Q18	Q19	Q20
2	3	2	1	4	4	1	3	3	2
Q21	Q22	Q23	Q24	Q25					
1	4	3	3	3					

26a	(i) Group A: dry scales (ii) Group B: feathers
26b	(i) Group A: reptiles (ii) Group B: birds
27a	True
27b	False
27c	False
27d	True
28a	D does not lay eggs but F lays eggs.
28b	C, F, D, E
29a	Type of bread Amount of water on the bread
29b	Yes. Mould needs warmth, air and water. In this case, the bread only has warmth and air because the toasting process removed the water, so the mould will not grow on the bread.

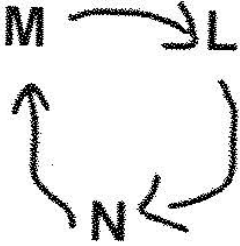
30a	
30b	Adult
31a	Eight days
31b	The layer of oil floating on water will clog the breathing tubes, causing the larva to not have air to survive, and it will die.
32	4, 1, 2, 3
33a	Set up A and Set up C
33b	A and B. There is presence of water. Water is needed by the seeds to germinate.
34a	Material X is transparent.
34b	No. Although X is transparent, it is not strong so it will not be able to hold the weight of the visitors without breaking.
35a	P, R, Q, S
35b	S. It was the most absorbent compared to the rest and part A of the mop needs to be absorbent to absorb the spilled liquid most effectively and quickly.
36a	Copper
36b	The set-up with Rod Z did not attract the steel clip as Z is made of copper which is a non-magnetic material.
36c	W. It attracted the steel clip from the furthest distance, showing that it has the most magnetic strength. Therefore, Mrs Gopal should use W.