



HENRY PARK PRIMARY SCHOOL  
2025 END OF YEAR EXAMINATION  
MATHEMATICS  
PRIMARY 4

Name: \_\_\_\_\_ (     )

Parent's Signature

Class: Primary 4 \_\_\_\_\_

\_\_\_\_\_

Duration of Paper: 1 h 30 min

Marks:

Section A (MCQ)	20
Section B (Open-Ended)	50
Section C (Problem Sums)	30
<b>Total</b>	<b>100</b>

**SECTION A: Multiple-Choice Questions (20 marks)**

Questions 1 to 10 carry 2 mark each.

For each question, four options are given. One of them is the correct answer.

Make your choice (1, 2, 3 or 4) and shade your answer in the Optical Answer Sheet.

---

1. In which of the following does the digit 6 stand for 600?

(1) 6790

(2) 7690

(3) 7906

(4) 9760

( )

2. In which of the following are the numbers arranged from the smallest to the greatest?

*(smallest)*

*(greatest)*

(1) 4890 , 4809 , 4089

(2) 4089 , 4890 , 4809

(3) 4890 , 4089 , 4809

(4) 4089 , 4809 , 4890

( )

3. The figure shown is made up of identical triangles.  
What fraction of the triangles is shaded?

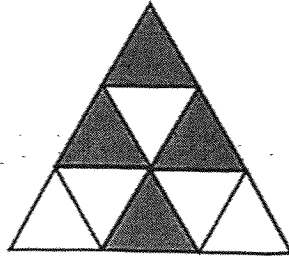

- (1)  $\frac{4}{5}$   
(2)  $\frac{4}{8}$   
(3)  $\frac{4}{9}$   
(4)  $\frac{5}{9}$

( )

4. Express  $\frac{28}{100}$  as a decimal.

- (1) 0.208  
(2) 0.028  
(3) 0.28  
(4) 2.08

( )

5. Find the sum of 0.4 and 81.23.

- (1) 85.23  
(2) 81.63  
(3) 81.27  
(4) 80.83

( )

6. Which angle is greater than a right angle?

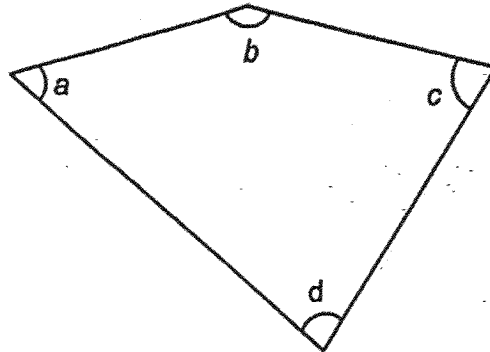

- (1)  $\angle a$
- (2)  $\angle b$
- (3)  $\angle c$
- (4)  $\angle d$

( )

7. ABCD is a square with an area of  $64 \text{ cm}^2$ . Find the length of one side of the square.

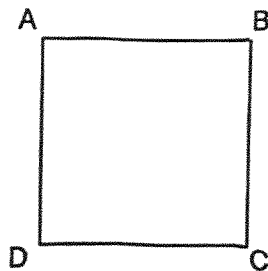

- (1) 32 cm
- (2) 16 cm
- (3) 8 cm
- (4) 4 cm

( )

8. The table below shows the number of books borrowed by some students from the library in a week.

Number of books borrowed	1	2	3	4	5
Number of students	35	112	265	184	67

How many students borrowed more than 3 books?

- (1) 147  
 (2) 251  
 (3) 265  
 (4) 516 ( )
9. Ethan took  $\frac{3}{4}$  h to complete a puzzle. His sister completed the puzzle  $\frac{1}{6}$  h faster than him. How long did his sister take to complete the puzzle?

- (1)  $\frac{4}{10}$  h  
 (2)  $\frac{2}{12}$  h  
 (3)  $\frac{7}{12}$  h  
 (4)  $\frac{11}{12}$  h ( )

10. ABCD is a rectangle.  $\angle x$  is twice the size of  $\angle y$ .  
Find  $\angle y$ .

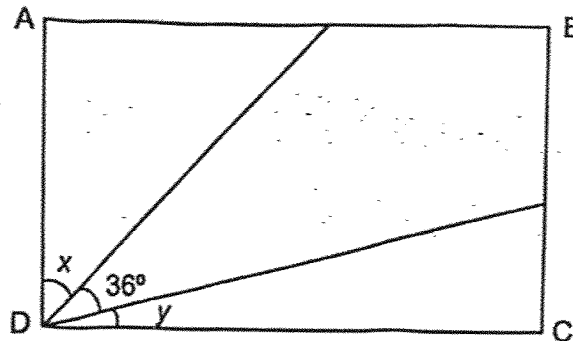

- (1)  $18^\circ$
- (2)  $27^\circ$
- (3)  $54^\circ$
- (4)  $72^\circ$

( )

— Last Page of Section A —

Go on to Section B

**SECTION B: Open-Ended Questions (50 marks)**

Questions 11 to 35 carry 2 marks each. Show your working clearly and write your answers in the spaces provided. For questions which require units, give your answers in the units stated.

Do not write  
in this space

11. Round 39 520 to the nearest hundred.

Ans: \_\_\_\_\_

12.  $2009 - 463 =$  \_\_\_\_\_

Ans: \_\_\_\_\_

13. Find the product of 1760 and 9.

Ans: \_\_\_\_\_

14. How many one-eighths are there in 1 whole?

Do not write  
in this space

Ans: \_\_\_\_\_

15.  $\frac{3}{5} = \frac{12}{\boxed{?}}$

What is the missing number in the box?

Ans: \_\_\_\_\_

16.  $\frac{2}{3} + \frac{2}{9} =$

Ans: \_\_\_\_\_

17. Write the decimal represented by A.

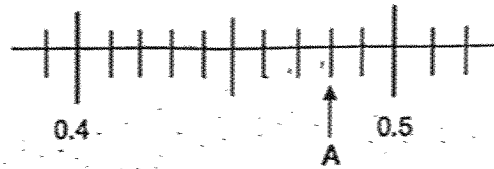

Ans: \_\_\_\_\_

Do not write  
in this space

18. Find the value of  $6.37 \times 8$

Ans: \_\_\_\_\_

19. Measure and write down the size of  $\angle x$ .

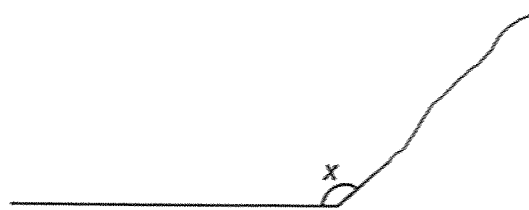

Ans: \_\_\_\_\_

20. The figure is made up of straight lines that meet at right angles.  
Find the perimeter of the figure.

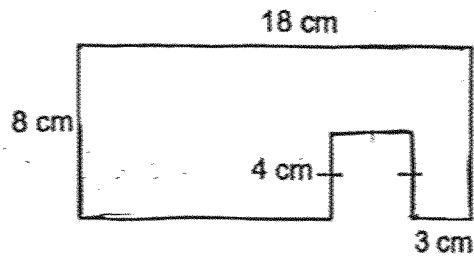

Do not write  
in this space

Ans: \_\_\_\_\_ cm

21. The sum of two numbers is 9081.  
The difference between the two numbers is 4523.  
What is the smaller number?

Ans: \_\_\_\_\_

22. The pie chart shows the favourite food of a group of children.  $\frac{1}{2}$  of the children chose nuggets as their favourite food.

Do not write  
in this space

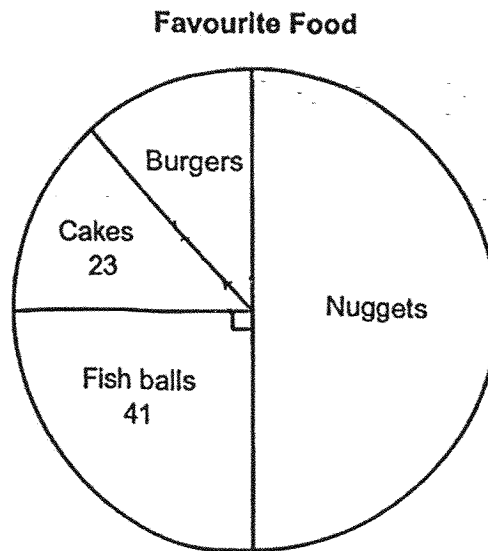

- (a) What fraction of the children chose cakes and burgers as their favourite food?

Ans: (a) \_\_\_\_\_

- (b) How many children like burgers?

Ans: (b) \_\_\_\_\_

23. A tank and 2 buckets contain 8.15 ℓ of water. The volume of water in the tank is 3 times the volume of water in each bucket. What is the volume of water in each bucket?

Do not write  
in this space

Ans: \_\_\_\_\_ ℓ

24. Mrs Toh had \$33.60. After paying \$7.80 for a packet of chocolate chip cookies, she had just enough money to buy 4 packets of butter cookies. How much did a packet of butter cookies cost?

Ans: \$ \_\_\_\_\_

25. In the square grid below, EF and EH are two sides of square EFGH. Complete and label the drawing of square EFGH.

Do not write  
in this space

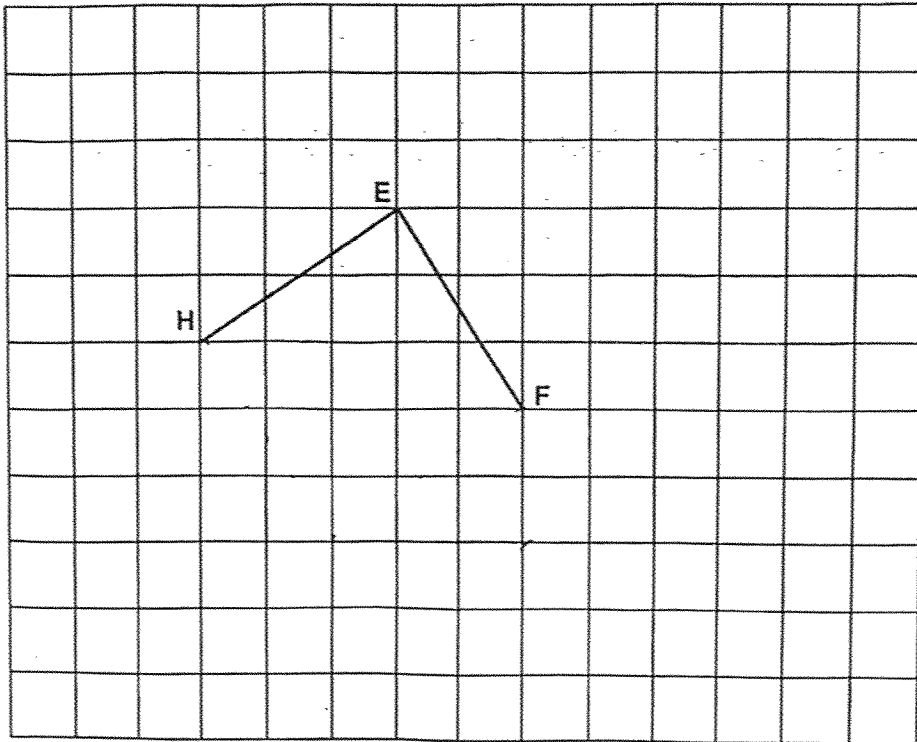

26. (a) There are 10 shaded squares in the figure. Shade 3 more squares to form a symmetric figure with XY as the line of symmetry.

Do not write  
in this space

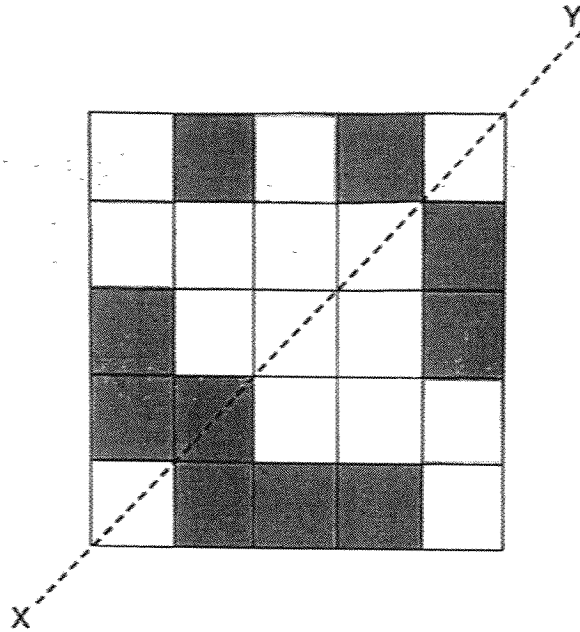

- (b) Complete the symmetric figure with line CD as the line of symmetry.

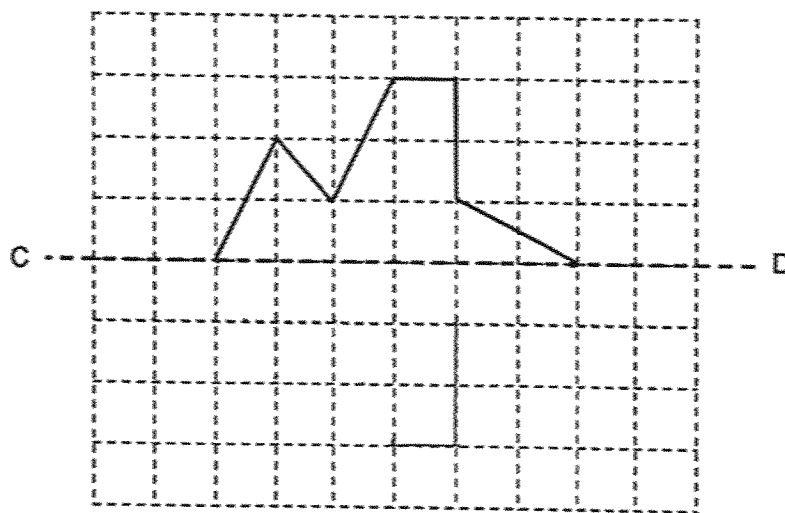

27. A rectangular piece of paper is folded as shown. What is the area of the rectangular piece of paper before it is folded?

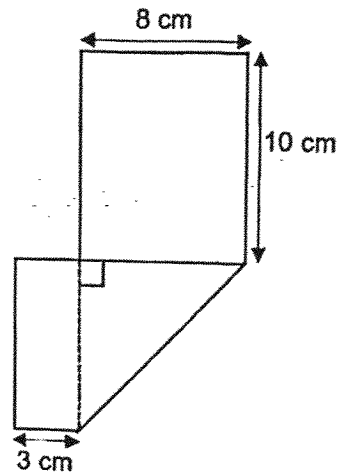

Ans: \_\_\_\_\_ cm<sup>2</sup>

Do not write  
in this space

28. Joseph and Kelvin started running at 11 45. Joseph took 1 h 10 min to complete his run. Kelvin took 30 minutes longer than Joseph. What time did Kelvin complete his run? Give your answer using the 24-hour clock.

Ans: \_\_\_\_\_

29. The graph below shows the number of bottle caps collected by 5 pupils for a Recycling Project.

Do not write in this space

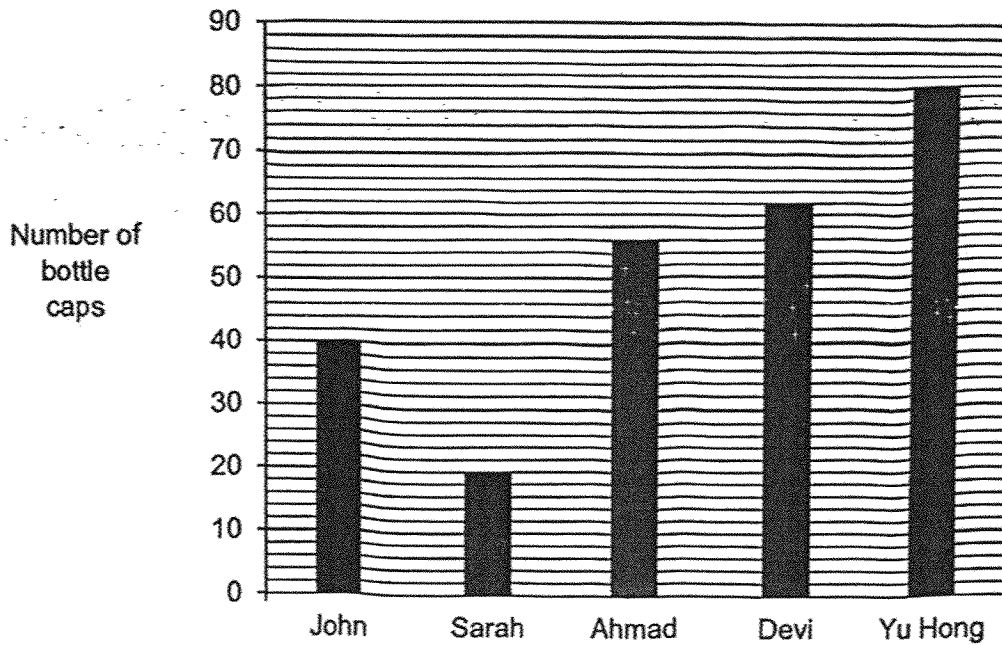

(a) How many bottle caps did Sarah, Ahmad and Devi collect in total?

Ans: (a) \_\_\_\_\_

(b) Who collected twice the number of bottle caps as John?

Ans: (b) \_\_\_\_\_



30. The line graph shows the amount of money saved by Sam from January to June.

Do not write  
in this space

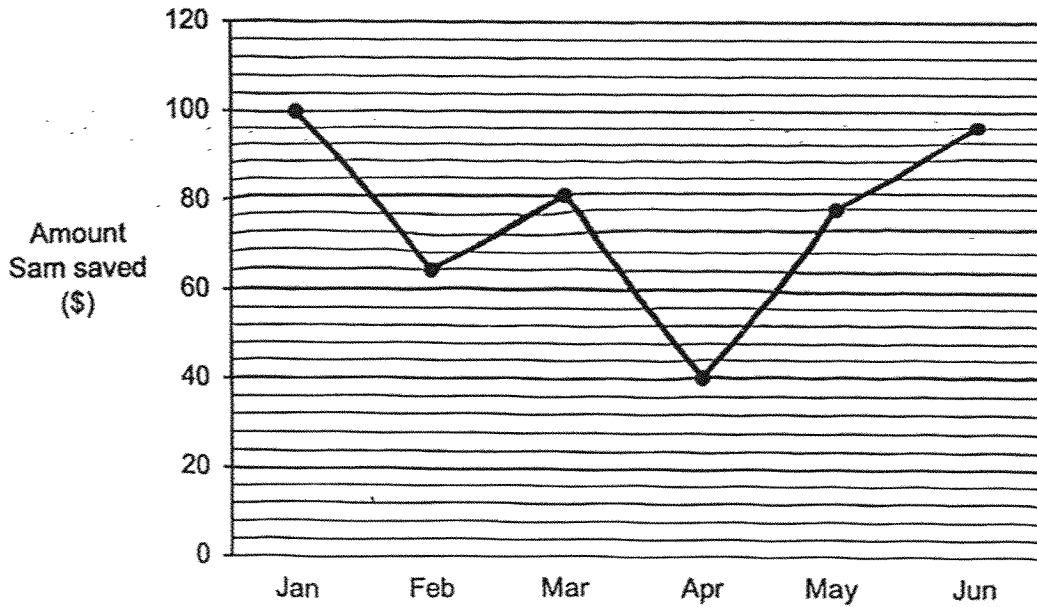

- (a) How much money did Sam save in February?

Ans: (a) \$ \_\_\_\_\_

- (b) During which 1-month period was the increase in the amount of money saved by Sam the greatest?

Ans: (b) \_\_\_\_\_ to \_\_\_\_\_



31. Which two of the following figures are not the nets of a cube?

Do not write  
in this space

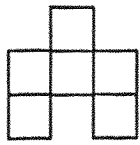

A

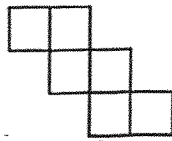

B

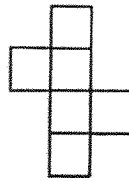

C

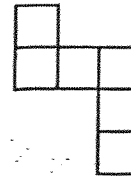

D

Ans: \_\_\_\_\_ and \_\_\_\_\_

32. Pears are sold at the prices shown below.

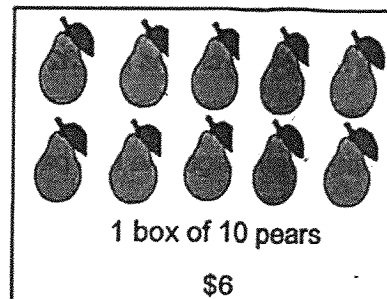
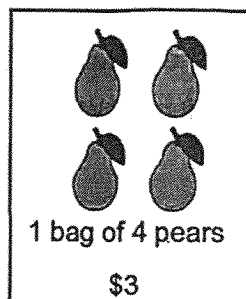
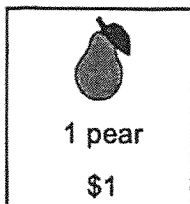

Claire wants to buy 16 pears for a class party. What is the least amount of money she needs to pay for the apples?

Ans: \$ \_\_\_\_\_

33.  $\frac{4}{7}$  kg of flour is needed to bake 6 buns. Melvin has 3 kg of flour and he baked 12 buns. How much flour does he have left?

Do not write  
in this space

Ans: \_\_\_\_\_ kg

34. Elsie has 24 keychains and 32 bookmarks. She packed the keychains and bookmarks equally into gift bags with none left over. What is the greatest number of gift bags she can pack?

Ans: \_\_\_\_\_

35. Mrs Tan baked some muffins.  $\frac{4}{5}$  of the muffins were chocolate and the rest were vanilla. There were 240 more chocolate muffins than vanilla muffins. How many vanilla muffins did Mrs Tan bake?

Do not write  
in this space

Ans: \_\_\_\_\_



— Last Page of Section B —

**SECTION C: Problem Sums (30 marks)**

For questions 36 to 43, show your working clearly and write your answers in the spaces provided. The number of marks available is shown in the brackets [ ] at the end of each question or part-question.

36. Ali bought 455 boxes of pens. Each box contained 12 pens.

(a) How many pens did Ali buy altogether?

Ans: (a) \_\_\_\_\_ [2]

(b) Ali repacked the pens into packets of 8. How many pens were left unpacked?

Ans: (b) \_\_\_\_\_ [2]

Do not write  
in this space

37. Fatimah and Ben had 828 stamps altogether. After Fatimah gave 68 stamps to Ben, Ben had three times as many stamps as Fatimah.

Do not write  
in this space

(a) How many stamps did Fatimah have in the end?

Ans: (a) \_\_\_\_\_ [2]

(b) How many stamps did Ben have at first?

Ans: (b) \_\_\_\_\_ [2]



38. Mr Chan bought a wallet, a belt and a shirt. The wallet cost twice as much as the belt. The shirt cost \$6 less than the belt. He paid \$90.80 in total.

Do not write  
in this space

(a) How much did the belt cost?

Ans: (a) \_\_\_\_\_ [3]

(b) How much did the wallet cost?

Ans: (b) \_\_\_\_\_ [1]

39. ABCD is a rectangle and EFGC is a square.

Do not write  
in this space

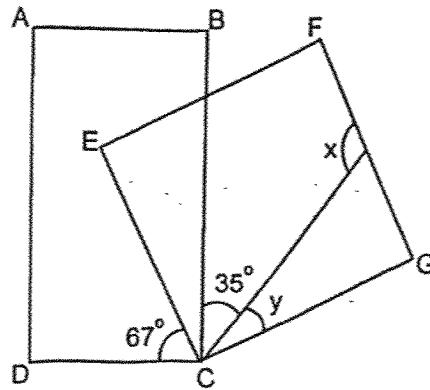

- (a) Circle the correct answer.

$\angle x$  is a/an ( acute / obtuse / right ) angle. [1]

- (b) Find  $\angle y$ .

Ans: (b) \_\_\_\_\_ [2]



40. Samantha started doing her homework at 15 35. She took 1 h 5 min to complete her homework. After that, she swam till 18 10.

Do not write  
in this space

(a) How long did she swim? Give your answer in hours and minutes.

Ans: (a) \_\_\_\_\_ [2]

(b) Ken started doing his homework 50 minutes before Samantha started doing her homework. He took 1 h 25 min to complete. What time did he finish his homework? Give your answer using the 12-hour clock.

Ans: (b) \_\_\_\_\_ [2]

41. Lisa spent  $\frac{4}{7}$  of her money on a mobile phone and \$65 on a set of earphones. She had \$190 left in the end. How much did the mobile phone cost?

Do not write  
in this space

Ans: \_\_\_\_\_ [3]

42. Cheryl had \$1253 and Fiona had \$845. After each of them bought a bag at the same price, Cheryl had 5 times as much money as Fiona.

Do not write  
in this space

(a) How much more money does Cheryl has than Fiona at first?

Ans: (a) \_\_\_\_\_ [1]

(b) What was the cost of the bag?

Ans: (b) \_\_\_\_\_ [3]

43. A piece of wire has a length of 116 cm. It is bent to form rectangle WXYZ. XY has a length of 12 cm.

Do not write  
in this space

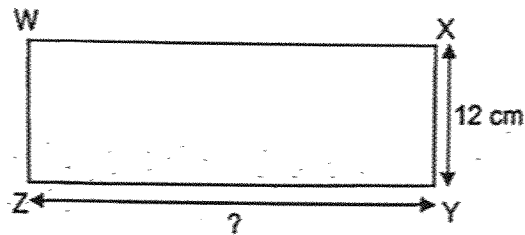

- (a) Find the length of ZY.

Ans: (a) \_\_\_\_\_ [2]

The same piece of wire is straightened and used to bent into 4 squares of different sizes as shown in the figure. PQ is straight line.

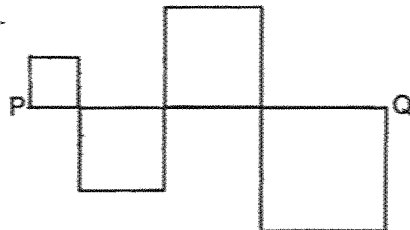

- (b) Find the length of PQ.

Ans: (b) \_\_\_\_\_ [2]

— END OF PAPER —

**SCHOOL : HENRY PARK PRIMARY SCHOOL**  
**LEVEL : PRIMARY 4**  
**SUBJECT : MATHEMATICS**  
**TERM : 2025 END OF YEAR EXAMINATION**

Q1	Q2	Q3	Q4	Q5	Q6	Q7	Q8	Q9	Q10
2	4	3	3	2	2	3	2	3	1

Q11 39 500

Q12 1 546

Q13 15 840

Q14 8

Q15 20

Q16  $\frac{2}{3} + \frac{2}{9} = \frac{8}{9}$

Q17 0.48

Q18 50.96

Q19 138°

Q20)  $18\text{cm} + 18\text{cm} + 8\text{cm} + 8\text{cm} + 8\text{cm} = 60\text{cm}$

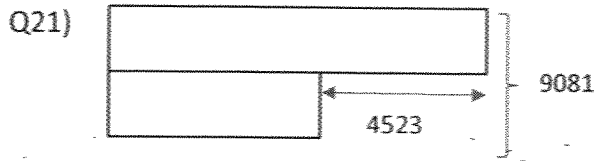

$$9081 - 4523 = 4558$$

$$4558 \div 2 = 2279$$

Ans:2279

Q22a)  $\frac{1}{4}$

Q22b)  $41 - 23 = 18$

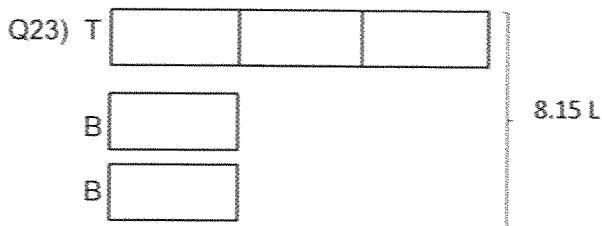

$$5u = 8.15$$

$$1u = 8.15 \div 5$$

$$= 1.63$$

Ans: 1.63 L

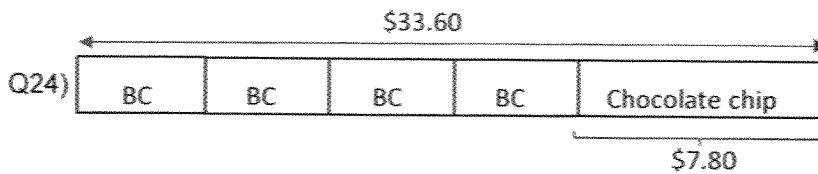

$$4u = 33.60 - 7.80$$

$$= 25.80$$

$$1u = 25.80 \div 4$$

$$= 6.45$$

Ans: \$6.45

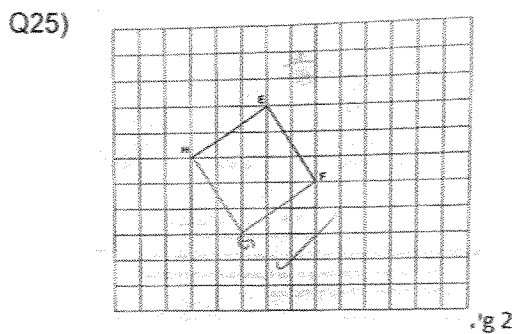

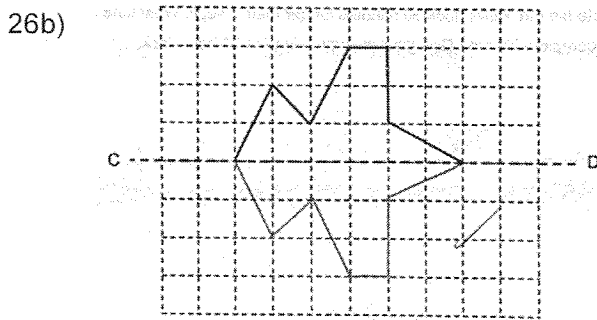
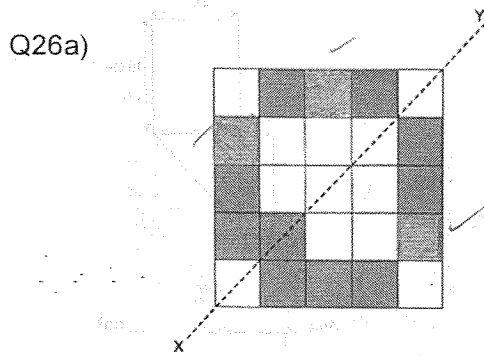

Q27) Length =  $10 + 8 + 3$   
 $= 21$   
 Breadth =  $8$   
 Area =  $L \times B$   
 $= 21 \times 8$   
 $= 168$

Ans :  $168 \text{ cm}^2$

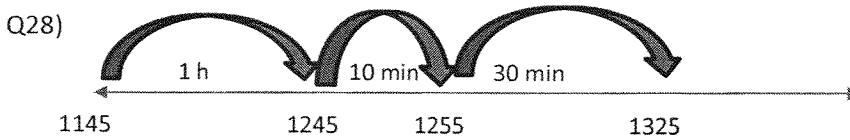

Ans: 1325

Q29a) 138 bottle caps

Q29b) Yu Hong

Q30a) \$64

Q30b) April to May

Q31) A and D

- Q32 1 box of 10 pears = \$6  
 1 box of 4 pears = \$3  
 $16 - 10 - 4 = 2$  (extra pears)  
 $2 \times \$1 = \$2$   
 $6 + 3 + 2 = 11$

**Ans: \$11**

- Q33  $\frac{4}{7}$ kg = 6 buns  
 $12 \text{ buns} = \frac{4}{7} \times 2$   
 $= \frac{8}{7}$   
 $= 1\frac{1}{7}$   
 $3 - 1\frac{1}{7} = 2\frac{7}{7} - 1\frac{1}{7}$   
 $= 1\frac{6}{7}$

**Ans:  $1\frac{6}{7}$ kg**

- Q34 **32**                      **24**  
 $1 \times 32$                    $1 \times 24$   
 $2 \times 16$                    $2 \times 12$   
 $4 \times 8$                      $3 \times 8$   
                                   $4 \times 6$

Find highest common multiple of 32 and 24

**Ans: 8 gift bags**

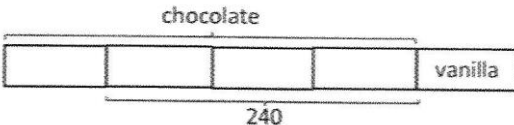
- Q35 

$$3 \text{ u} = 240$$

$$1 \text{ u} = 240 \div 3$$

$$= 80$$

**Ans: 80 vanilla muffins**

- Q36a  $455 \times 12 = 5460$

**Ans: 5460 pens**

- Q36b  $5460 \div 8 = 682 \text{ R } 4$

**Ans: 4 pens**

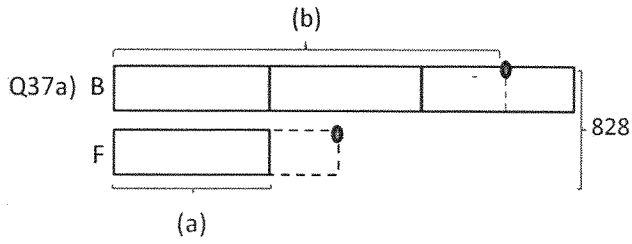

$$4 u = 828$$

$$1 u = 828 \div 4$$

$$= 207$$

Ans (a): 207 stamps

b)  $3 u = 207 \times 3$   
 $= 621$   
 $621 - 68 = 553$

Ans (b): 553 stamps

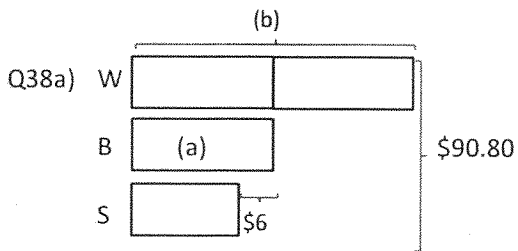

(a)  $4 u = 90.80 + 6.00$   
 $= 96.80$   
 $1 u = 96.80 \div 4$   
 $= 24.20$

Ans (a) : \$24.20

(b)  $2 u = 24.20 \times 2$   
 $= 48.40$

Ans (b) : \$48.40

Q39a) obtuse

b)  $90^\circ - 67^\circ = 23^\circ$   
 $23^\circ + 35^\circ = 58^\circ$   
 $90^\circ - 58^\circ = 32^\circ$

Ans (b) :  $32^\circ$

Q40a)

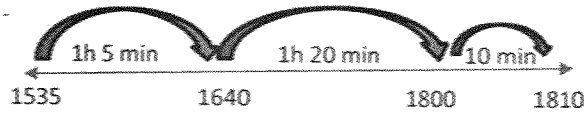

$$1\text{h } 20\text{ min} + 10\text{ min} = 1\text{h } 30\text{ min}$$

Ans : 1h 30 min

$$\begin{aligned} \text{(b) } 15\text{h } 35\text{min} - 50\text{min} &= 14\text{h } 45\text{min} \\ 14\text{h } 45\text{min} + 1\text{h } 25\text{min} &= 15\text{h } 70\text{ min} \\ &= 16\text{h } 10\text{min} \end{aligned}$$

$$1610 = 4.10\text{pm}$$

Ans (b) : 4.10pm

Q41)



$$\begin{aligned} 3u &= 65 + 190 \\ &= 255 \\ 1u &= 255 \div 3 \\ &= 85 \\ 3u &= 85 \times 4 \\ &= 340 \end{aligned}$$

Ans : \$340

Q42) C

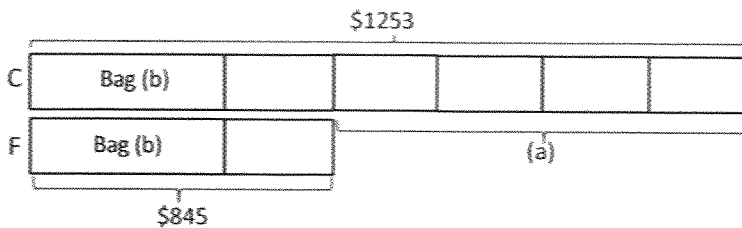

$$\begin{aligned} \text{(a) } 4u &= 1253 - 845 \\ &= 408 \end{aligned}$$

Ans (a): \$408

$$\begin{aligned} \text{(b) } 1u &= 408 \div 4 \\ &= 102 \\ 845 - 102 &= 743 \end{aligned}$$

Ans (b) : \$743

$$\begin{aligned} \text{Q43a) } 12 \times 2 &= 24 \\ 2L &= 116 - 24 \\ &= 94 \\ 1L &= 94 \div 2 \\ &= 46 \end{aligned}$$

Ans (a) : 46 cm

$$\text{(b) } 116 \div 4 = 29$$

Ans (b) : 29 cm

.CC

[www.sgexam.com](http://www.sgexam.com)