

Ai Tong School
P5 Mathematics
2025 Term 2 Review

Name: _____ () Class : 5 _____

Date: _____ Marks: _____/35

Duration: 60 min Parent's signature: _____

Follow all instructions. Answer all questions.
You are allowed to use a calculator.

Section A

Questions 1 to 5 carry 2 marks each. Show your working clearly in the space provided for each question and write your answers in the spaces provided.

For questions which require units, give your answers in the units stated. (10 marks)

- 1 (a) Express 6095 cm^3 in ℓ and $\text{m}\ell$.

Ans: _____ ℓ _____ $\text{m}\ell$

- (b) Express 8 kg 20 g in kg.

Ans: _____ kg

- 2 The cuboid shown has a height of 8 cm and a square base of side 3 cm. Find its volume.

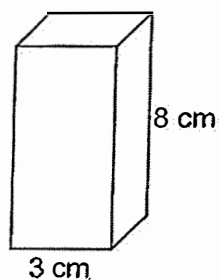

Ans: _____ cm^3

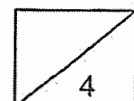

3 Find the area of the shaded triangle.

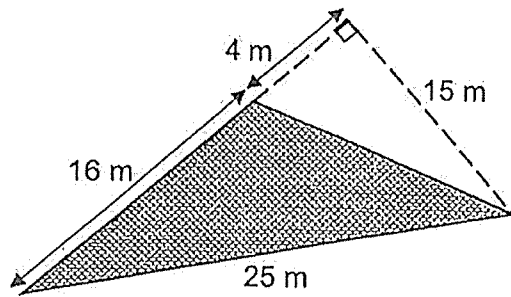

Ans: _____ m²

4 A wire is 2.5 m long. Some of it is used to form a triangle with 3 equal sides. Each side of the triangle is 75 cm. What is the length of wire that is left unused?

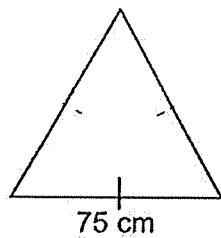

Ans: _____ cm

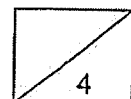

- 5 7 unit cubes were stacked and glued together to form the solid below.

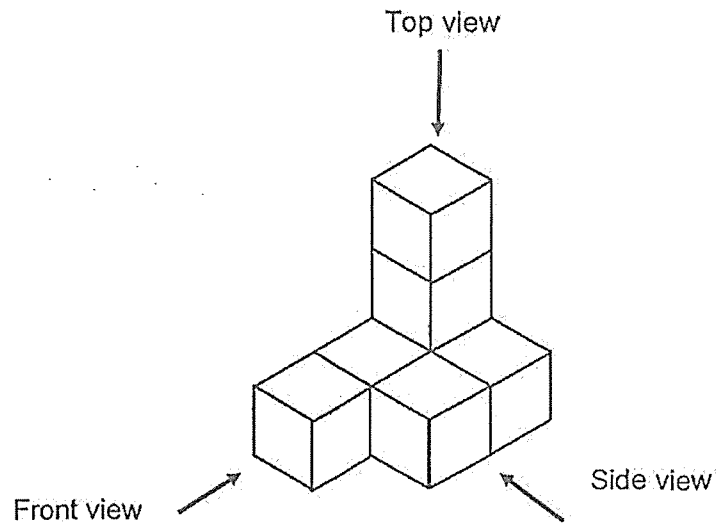

Draw the side view and the top view of the solid on the grid below.

Side view	Top view
• • • • • • •	• • • • • • •
• • • • • • •	• • • • • • •
• • • • • • •	• • • • • • •
• • • • • • •	• • • • • • •
• • • • • • •	• • • • • • •
• • • • • • •	• • • • • • •
• • • • • • •	• • • • • • •

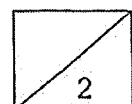

Section B

For questions 6 to 12, show your working clearly in the space provided for each question and write the answers in the spaces provided. The number of marks available is shown in the brackets [] at the end of each question or part-question. (25 marks)

- 6 In a competition, $\frac{3}{5}$ of the participants were men. $\frac{1}{3}$ of the remaining participants were women and the rest were children. There were 225 more men than children. How many participants were there in the competition?

Ans: _____ [3]

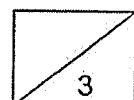

- 7 At a party, a rectangular container measuring 45 cm by 38 cm by 40 cm was $\frac{5}{8}$ filled with fruit punch at first. Each guest was served with a 550 mL cup of fruit punch. What was the greatest possible number of such cups of fruit punch served?

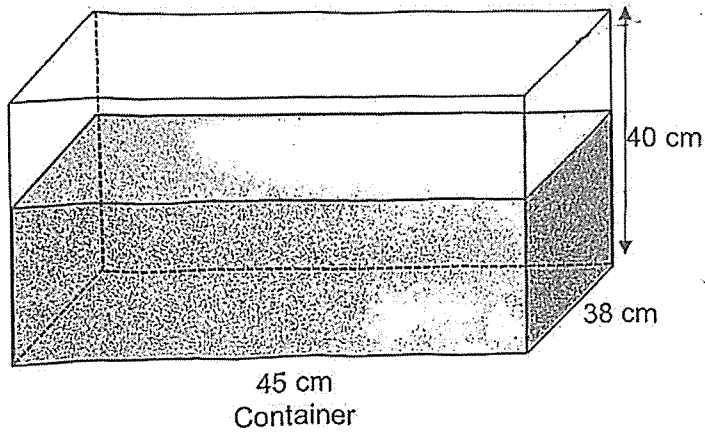

Ans: _____ [3]

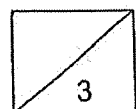

- 8 The cost of 2 pens and 4 files is \$23.90. The cost of a file is \$1.40 more than the cost of a pen. Find the cost of a pen:

Ans: \$ _____ [3]

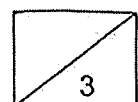

- 9 Amanda went shopping with some money. She spent $\frac{1}{3}$ of her money on a table, $\frac{1}{4}$ of it on a sofa and \$54 on a lamp. Then, she had $\frac{1}{6}$ of her money left. How much did she spend on the table?

Ans: \$ _____ [3]

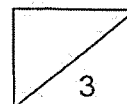

10. Rectangle ACEH is made up of two identical rectangles, BCDK and KDEF and two identical squares, ABKJ and JKFH. $AC = 21$ cm and $DE = 6$ cm.

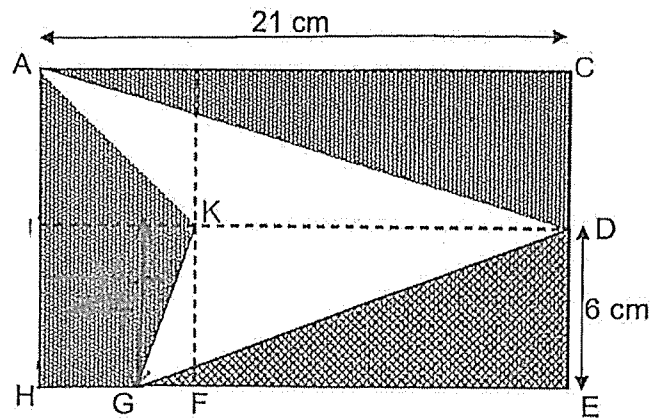

- (a) Find the area of triangle GKD.

Ans: (a) _____ cm^2 [2]

- (b) Find the total area of the shaded parts.

Ans: (b) _____ cm^2 [2]

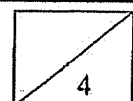

- 11 A total of 60 light bulbs are set up at an equal distance apart around a rectangular garden ABCD. A light bulb is set up at each corner of the garden. The distance between every two light bulbs is 30 cm.

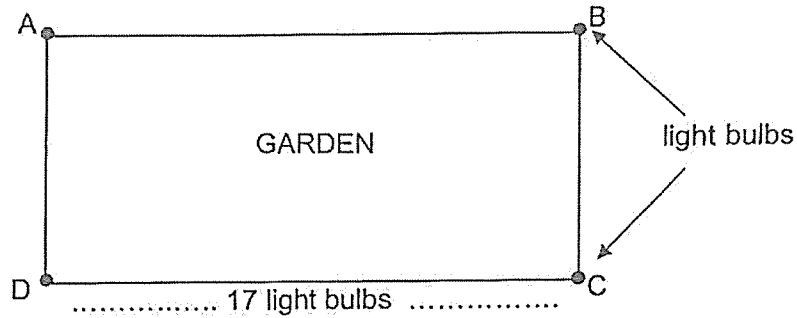

- (a) 17 light bulbs are set up along side DC. Find the length of DC.

Ans: (a) _____ cm [2]

- (b) How many light bulbs are placed along BC?

Ans: (b) _____ [3]

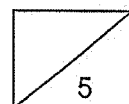

- 12 Daryl and Ben had an equal amount of money at first. Each day, Daryl spent \$5.50 and Ben spent \$3.20. After some days, Daryl had \$95.20 left and Ben had \$132 left. How much money did each of them have at first?

Ans: \$ _____ [4]

End of Paper
-- CHECK YOUR WORK CAREFULLY --

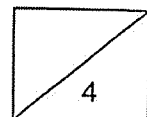

SCHOOL : AI TONG SCHOOL
LEVEL : PRIMARY 5
SUBJECT : MATHEMATICS
TERM : 2025 TERM 2 REVIEW

Section A

1a) 6 ℓ 95 m ℓ

b) 8.02 Kg

2) 72 cm³

3) Area of shaded part = $\frac{1}{2} \times 16 \times 15 = 120$

Ans : 120 cm²

4) 2.5 m = 2.5 × 100
= 250 cm

75 × 3 = 225

250 - 225 = 25

Ans : 25 cm

5)

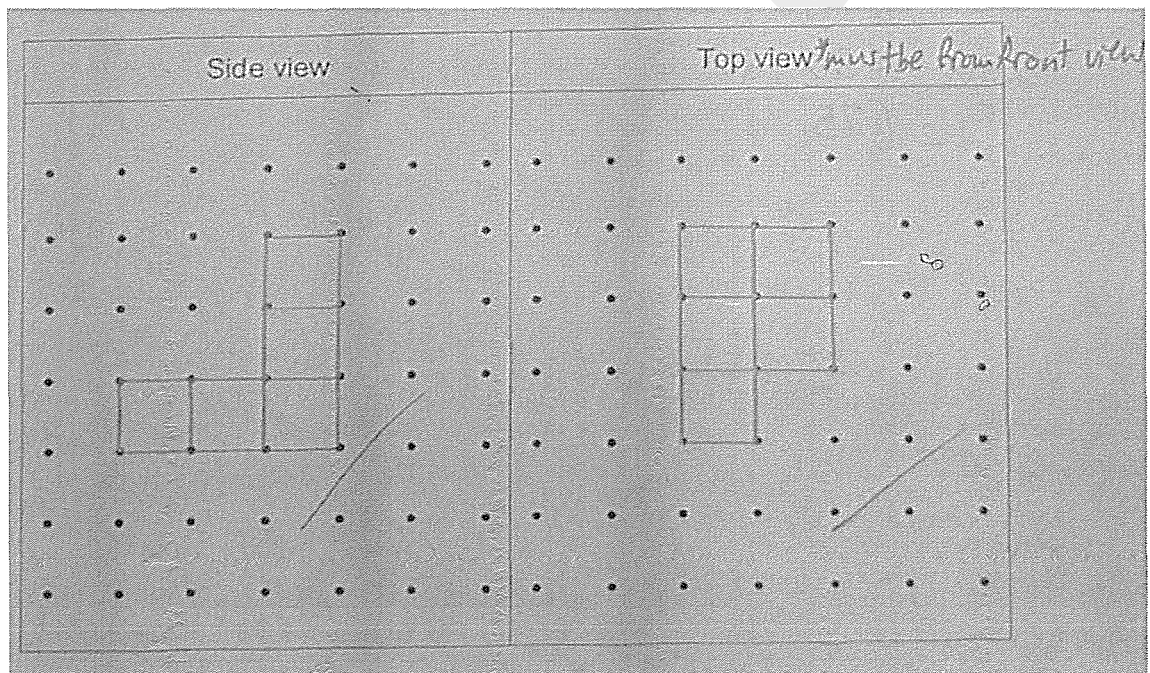

Q6)

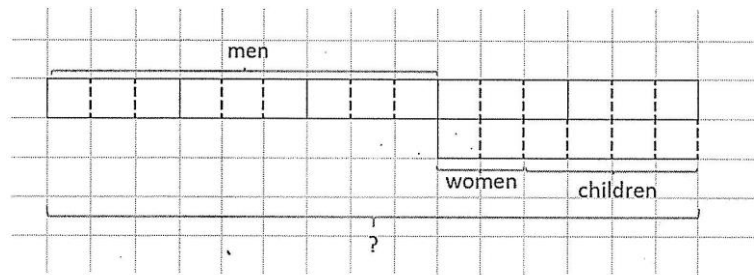

$$9 \text{ parts} - 4 \text{ parts} = 5 \text{ parts}$$

$$5 \text{ parts} = 225$$

$$1 \text{ part} = 225 \div 5 \\ = 45$$

$$15 \text{ parts} = 45 \times 15 \\ = 675$$

Ans: 675 participants

Q7) Vol of fruit punch = $\frac{5}{8} \times 45 \times 38 \times 40$
 $= 42750$

$$42750 \div 550 = 77 \text{ r } 400 \text{ m}\ell$$

Ans: 77 cups

Q8)

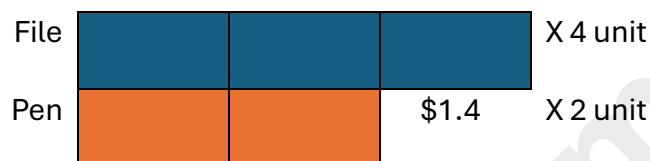

$$1.40 \times 4 = 5.60$$

$$6 \text{ units (minus cost difference)} = 23.90 - 5.60 \\ = 18.30$$

$$1 \text{ unit} = 18.30 \div 6 \\ = 3.05$$

Ans: \$3.05

Q9)

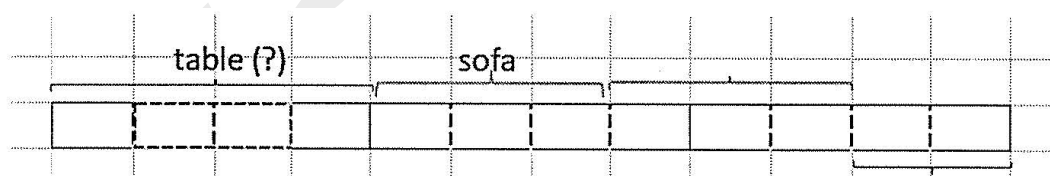

$$3 \text{ parts} = 54$$

$$1 \text{ part} = 54 \div 3 \\ = 18$$

$$4 \text{ parts} = 18 \times 4 \\ = 72$$

Ans: \$72

Q10a) $21 - 6 = 15$

$$\begin{aligned} \text{Area of GKD} &= \frac{1}{2} \times 6 \times 15 \\ &= 45 \end{aligned}$$

Ans: 45 cm^2

b) Area of Rectangle ACEH = 21×12
= 252

Area of AKD = GKD = 45 cm^2

$$\begin{aligned} \text{Area of shaded parts} &= 252 - 45 - 45 \\ &= 162 \end{aligned}$$

Ans : 162 cm^2

Q11a)

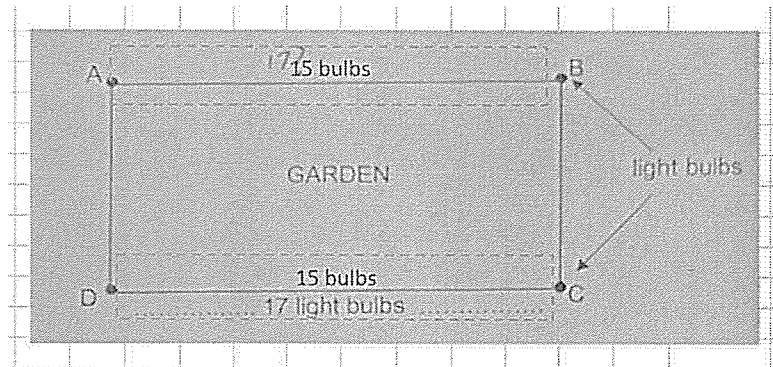

$17 \text{ light bulbs} = 16 \text{ gaps}$

$16 \times 30 = 480$

Ans (a): 480 cm

(b) $60 - 17 - 17 = 26$

$26 \div 2 = 13$

$13 + 1 + 1 = 15$

Ans (b): 15 light bulbs

Q12) $5.50 - 3.20 = 2.30$ (Ben spent \$2.30 less per day)

$132 - 95.20 = 36.80$ (Ben saved \$36.80 more)

$36.80 \div 2.30 = 16$

$16 \times 5.50 = 88$

$88 + 95.20 = 183.20$

Ans : \$183.20

20