

Nanyang Primary School
Primary 5
Mathematics
Term 2 Weighted Assessment

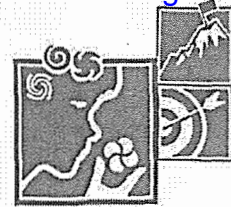

Marks:
/20

Name: _____ ()

Class: Primary 5 ()

Date: _____

Parent's Signature: _____

Duration: 40 minutes

The use of an approved calculator is allowed.

Please sign and return the paper the next day. Any queries should be raised at the same time when returning paper.



Questions 1 to 2 carry 2 marks each. Show your working clearly and write your answers in the spaces provided. For questions which require units, give your answers in the units stated. (4 marks)

1 (a) Ali builds a solid using 9 unit cubes.

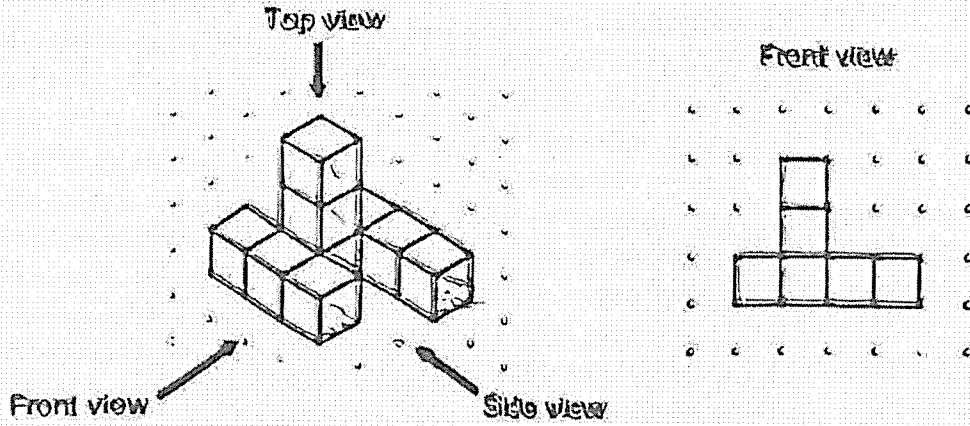

Draw the side view of the solid on the grid below.

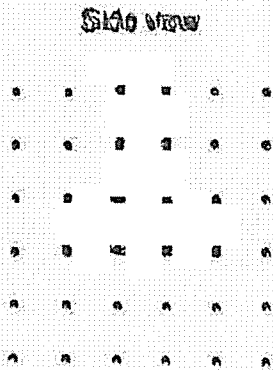

(b) Find the greatest number of unit cubes Ali can add to the solid without changing the front view and side view.

Ans: _____

- 2 Jack had some marbles at first. He sold $\frac{1}{5}$ of the marbles. He then gave $\frac{5}{8}$ of the remaining marbles to his sister. He had 360 marbles left in the end. How many marbles did he have at first?

Ans: _____

For questions 3 to 6, show your working clearly and write your answers in the spaces provided. The number of marks available is shown in brackets [] at the end of each question or part-question. (16 marks)

- 3 Anna had $\frac{7}{8}$ kg of flour at first. She used $\frac{3}{7}$ of the flour to bake a cake. Bob used $\frac{1}{4}$ kg of flour more than Anna. How much flour did Bob use? Give your answer in kg.

Ans: _____ kg [3]

- 5 The figure below shows a rectangular tank. It was $\frac{5}{7}$ - filled with water at first.

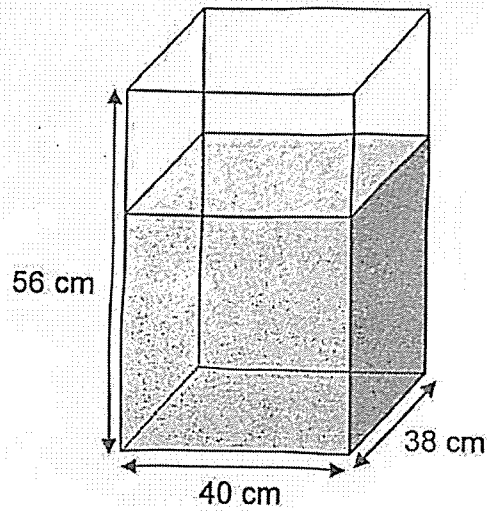

- (a) How much water was in the tank at first?

Ans: (a) _____ cm^3 [2]

- (b) Syakir poured the water from the tank to completely fill as many empty bottles as possible. The capacity of each bottle was 225 cm^3 . How much water was left in the tank in the end?

Ans: (b) _____ cm^3 [2]

6. At an amusement park, $\frac{1}{3}$ of the visitors were children. $\frac{1}{6}$ of the children were boys and $\frac{1}{4}$ of the adults were men. There were 196 men and boys altogether.

(a) How many visitors were there at the amusement park?

Ans: (a) _____ [3]

- (b) After some children went home, there were three times as many adults as children left at the amusement park. How many children went home?

Ans: (b) _____ [2]

End of Paper

SCHOOL : NANYANG PRIMARY SCHOOL
LEVEL : PRIMARY 5
SUBJECT : MATHEMATICS
TERM : 2025 WEIGHTED ASSESSMENT 2

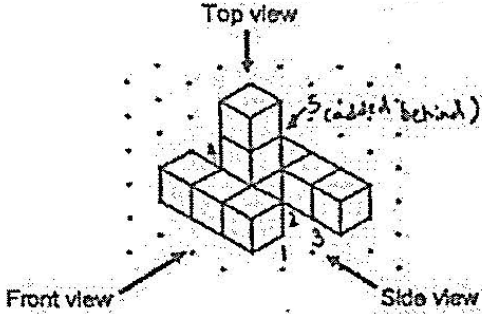
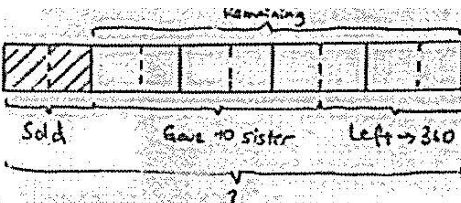
1a)	
1b)	5
2)	 <p>3 units = 360</p> <p>1 unit = $360 \div 3$ = 120</p> <p>10 units = 120×10 = 1200 (ans)</p> <hr/> <p><u>Alternative method</u></p> <p>$1 - \frac{1}{5} = \frac{4}{5}$ → Fraction of marbles at first remaining</p> <p>$1 - \frac{5}{8} = \frac{3}{8}$ → Fraction of remaining marbles left</p> <p>$\frac{3}{8} \times \frac{4}{5} = \frac{3}{10}$ → Fraction of marbles at first left</p> <p>$\frac{3}{10}$ of marbles at first → 360</p> <p>$\frac{1}{10}$ of marbles at first → $360 \div 3$ = 120</p> <p>Ans: <u>1200</u></p> <p>Ans: 1200</p>

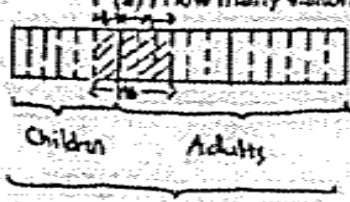
3)	<p>Amount of flour remaining $\rightarrow \frac{3}{7} \times \frac{7}{8} \text{kg} = \frac{3}{8} \text{kg}$</p> <p>Amount of flour Bob used $\rightarrow \frac{3}{8} \text{kg} + \frac{1}{8} \text{kg} = \frac{5}{8} \text{kg}$</p> <p>Ans: $\frac{5}{8} \text{kg}$</p>
4a)	<p>$AC \rightarrow 10 + 8 = 18$</p> <p>$BC \rightarrow 16 + 8 = 24$</p> <p>Area of $ABC \rightarrow \frac{1}{2} \times 18 \times 24 = 216 \text{ (cm}^2\text{)}$</p>
4b)	<p>Area of $COEF \rightarrow 8 \times 8 = 64$</p> <p>Area of $ADEFB \rightarrow 216 - 64 = 152$</p> <p>Area of $GFGDH = \text{Area of } ADEFB$</p> <p>Thus, area of shaded parts $\rightarrow 152 \times 2 = 304 \text{ (cm}^2\text{)}$</p> <p>Ans: 304 cm^2</p>
5a)	<p>$\frac{5}{2} \times 56 \times 40 \times 38 = 60800 \text{ (cm}^3\text{)}$</p> <p>Ans: 60800 cm^3</p>
5b)	<p>$60800 \div 225 \approx 270$</p> <p>270 bottles were filled completely</p> <p>$270 \times 225 = 60750$</p> <p>$60800 - 60750 = 50 \text{ (cm}^3\text{)}$</p> <p>Ans: 50 cm^3</p>
6a)	<p>$\frac{1}{4}$ of children $\rightarrow \frac{1}{4} = \frac{2}{8}$ of adults</p> <p>(a) How many visitors were there at the amusement park?</p>  <p> $\frac{1}{4} \times \frac{1}{3} = \frac{1}{12}$ Fraction of visitors that were boys $\frac{1}{12}$ of visitors $\rightarrow 196 \div 4 = 49$ </p> <p> $1 - \frac{1}{3} = \frac{2}{3}$ Fraction of visitors that were adults $\frac{1}{4} \times \frac{2}{3} = \frac{1}{6}$ Fraction of visitors that were men $\frac{1}{6} + \frac{1}{12} = \frac{1}{4}$ Fraction of visitors that were boys and men $\frac{1}{4}$ of visitors $\rightarrow 196$ </p> <p> $4 \text{ units} = 196$ $18 \text{ units} = 4 \times 18 = 882 \text{ (cm)}$ $1 \text{ unit} = 196 \div 4 = 49$ </p> <p>Ans: (a) <u>882</u> [3]</p>

6b)

$$\begin{aligned} \text{Number of adults} &\rightarrow \frac{2}{3} \times 882 \\ &= 588 \end{aligned}$$

$$\begin{aligned} \text{Number of children} \\ \text{at the end} &\rightarrow 588 \div 3 \\ &= 196 \end{aligned}$$

$$\begin{aligned} \text{Number of children} \\ \text{at first} &\rightarrow \frac{1}{2} \times 882 \\ &= 294 \end{aligned}$$

$$294 - 196 = 98 \text{ (ans)}$$

$$\text{Ans: (b) } \underline{\quad 98 \quad} [2]$$

Ans: 98

www.sgexam.com

www.sgexam.com