



MAHA BODHI SCHOOL  
2025 END OF YEAR EXAMINATION  
PRIMARY FIVE SCIENCE  
(BOOKLET A)

Name : \_\_\_\_\_ (      )

Class : Primary 5 \_\_\_\_\_

Date : 27 Oct 2025

Total Duration for Booklets A and B: 1 h 45 min

---

**INSTRUCTIONS TO CANDIDATES:**

1. Do not turn over this page until you are told to do so.
2. Follow all instructions carefully.
3. Answer all questions.
4. Shade your answers in the Optical Answer Sheet (OAS) provided.

This booklet consists of **18** printed pages.

**BLANK PAGE**

**BOOKLET A : [30 x 2 marks = 60 marks]**

For each question from 1 to 30, four options are given. One of them is the correct answer. Make your choice (1, 2, 3 or 4). Shade your answer on the Optical Answer Sheet.

1. What is/are the function(s) of a leaf?

- A. make food
- B. absorb water
- C. exchange of gases
- D. transport food to plant parts

- (1) A only
- (2) A and C only
- (3) B and D only
- (4) A, C and D only

2. Which part does **not** match its system correctly?

	part	system
(1)	windpipe	digestive
(2)	lungs	respiratory
(3)	blood vessels	circulatory
(4)	food-carrying tube	plant transport

3. Which of the following about how plants and human transport substances is **not** correct?

	Question	Plant transport system	Human circulatory system
(1)	Transports substances in tubes?	Yes	Yes
(2)	Needs a pump to push substances?	No	Yes
(3)	Transports substances to different parts?	Yes	Yes
(4)	Transports food and water through same tubes?	Yes	No

4. The diagram below shows how blood transports substances around the human body. Arrows A, B, C and D represent the flow of blood in the body.

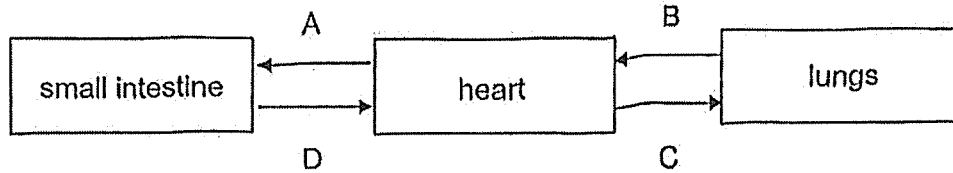

Which arrows represent the flow of blood containing the least amount of oxygen and most amount of digested food?

	flow of blood with least amount of oxygen	flow of blood with most amount of digested food
(1)	C	A
(2)	C	D
(3)	B	D
(4)	A	B

5. The table below shows the amount of gases in inhaled and exhaled air.

gas	amount of gas in inhaled air (%)	amount of gas in exhaled air (%)
nitrogen	78	78
oxygen	21	16
carbon dioxide	0.04	4.4
water vapour	0.96	1.6

Based on the above information, which gas does not enter or leave the blood when air passes through the lungs?

- (1) nitrogen
- (2) oxygen
- (3) carbon dioxide
- (4) water vapour

6. Which of the following is not needed for germination?

- (1) light
- (2) water
- (3) oxygen
- (4) warmth

7. The diagrams below show the human male and female reproductive systems.

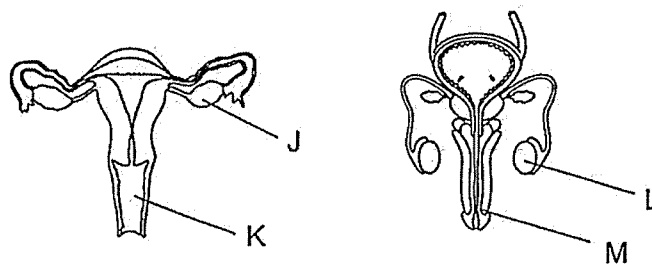

Which parts produce the female and male reproductive cells?

	Part which produces the male reproductive cell	Part which produces the female reproductive cell
(1)	J	K
(2)	J	L
(3)	M	K
(4)	L	J

8. The diagram below shows the life cycle of a flowering plant.

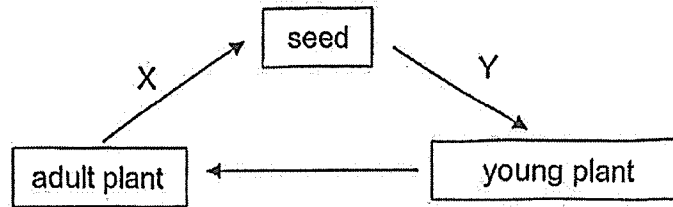

Which of the following correctly identifies processes X and Y?

	X	Y
(1)	germination	pollination
(2)	pollination	fertilisation
(3)	fertilisation	dispersal
(4)	dispersal	germination

9. Which of the following animals has young that do not look like the adult?

- (1) frog
- (2) chicken
- (3) cockroach
- (4) grasshopper

10. Which of the following correctly shows the life cycle of a mosquito?

- (1)
- 
- (2)
- 
- (3)
- 
- (4)
-

11. The diagram shows how substances P and Q are transported in a plant. X and Y represent different parts of the plant. The arrows represent the movement of substances P and Q.

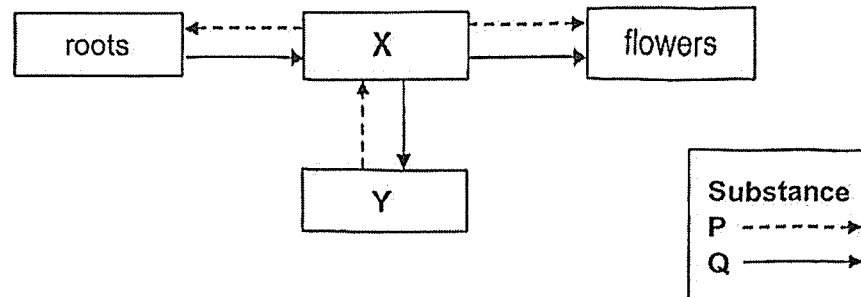

Which of the following correctly identifies Q and Y?

	Substance Q	Part Y
(1)	food	stem
(2)	food	leaves
(3)	water	stem
(4)	mineral salts	leaves

12. John plucked a leaf from a plant and placed it in a beaker of hot water.

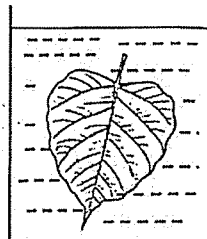

After a while, he observed that bubbles formed only on the lower surface of the leaf.

Based on the information, which of the following is correct?

- (1) Air exited through openings on both surfaces of the leaf.
- (2) Bubbles in the water landed onto the lower surface of the leaf.
- (3) Air entered the upper surface of leaf and exited through the lower surface.
- (4) The leaf had openings on the lower surface but not on its upper surface.

13. The diagram shows the roots of a plant placed into two containers of coloured water.

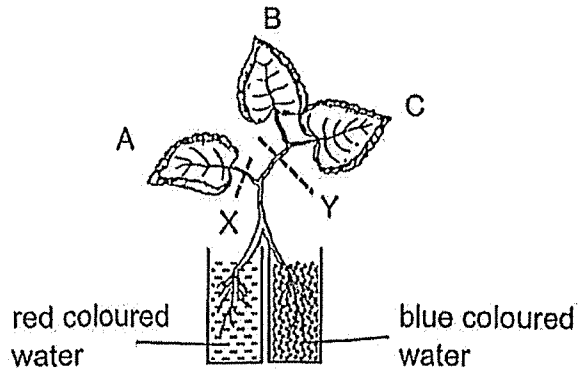

The table below recorded the observations of the leaves A, B and C after a few hours.

Leaf	Observation
A	Had red parts only
B	Had red and blue parts
C	Had blue parts only

Two cuts X and Y were made on the plant as shown above.

Which of the following correctly shows the observations of the surfaces of the cut parts X and Y?

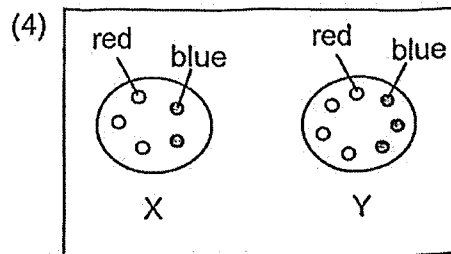
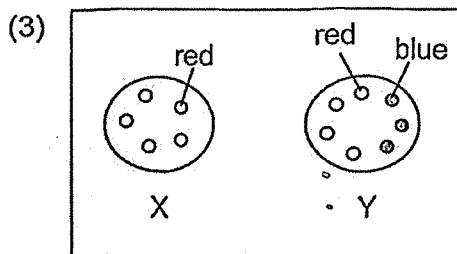
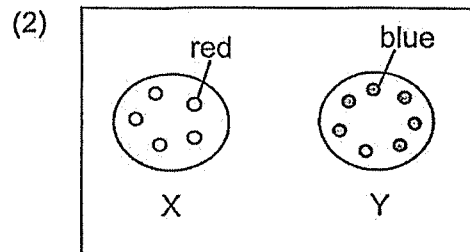
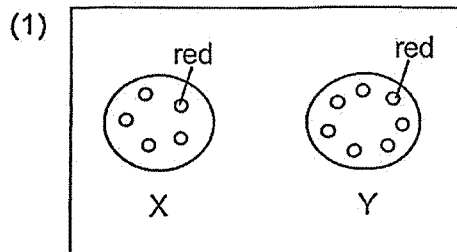

14. The table below shows 5 set-ups to be used for germination experiment.

Set-up	Number of seeds	Surrounding temperature (°C)	Amount of light (units)	Type of cotton wool
P	6	10	100	dry
Q	7	25	100	moist
R	6	10	50	dry
S	7	25	50	moist
T	7	25	50	dry

Which two set-ups should be used to find out if the amount of light affects the germination of seeds?

- (1) P and R
- (2) R and T
- (3) Q and S
- (4) Q and T

15. Three different types of plants were planted at different places as shown in Diagram K. After some time, some young plants were observed growing in the same area as shown in Diagram L.

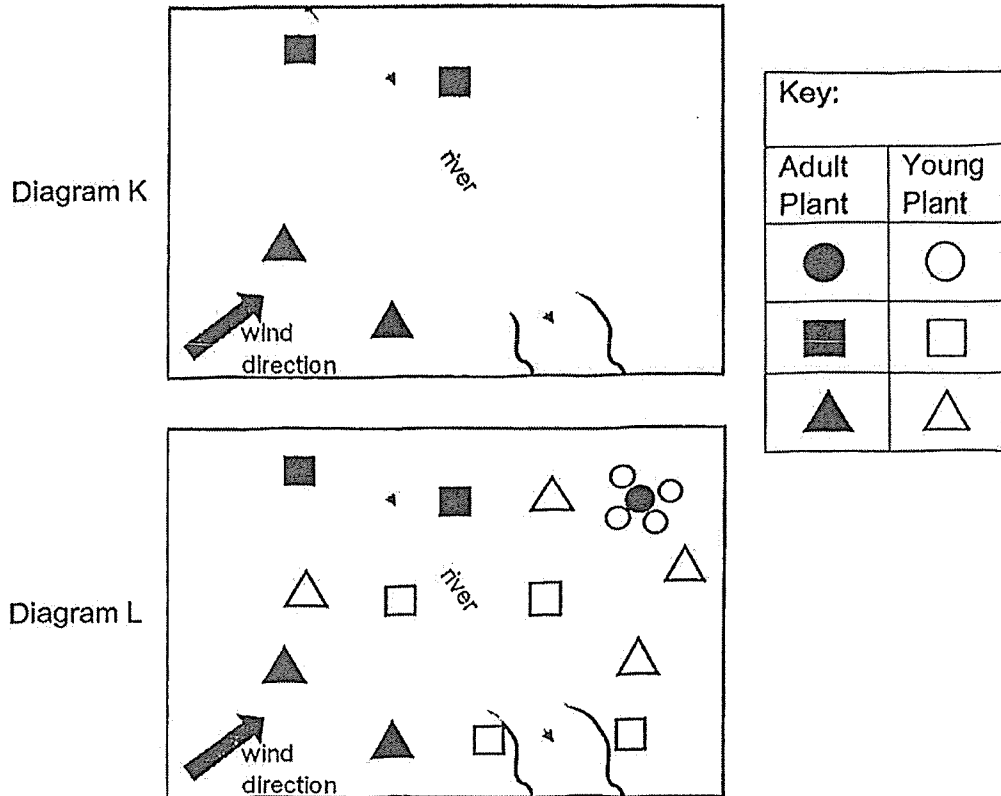

Based on the information above, how are the seeds of each type of plant dispersed?

	●	■	▲
(1)	water	splitting	animal
(2)	animal	splitting	wind
(3)	wind	animal	water
(4)	splitting	water	wind

16. Study the flowchart below.

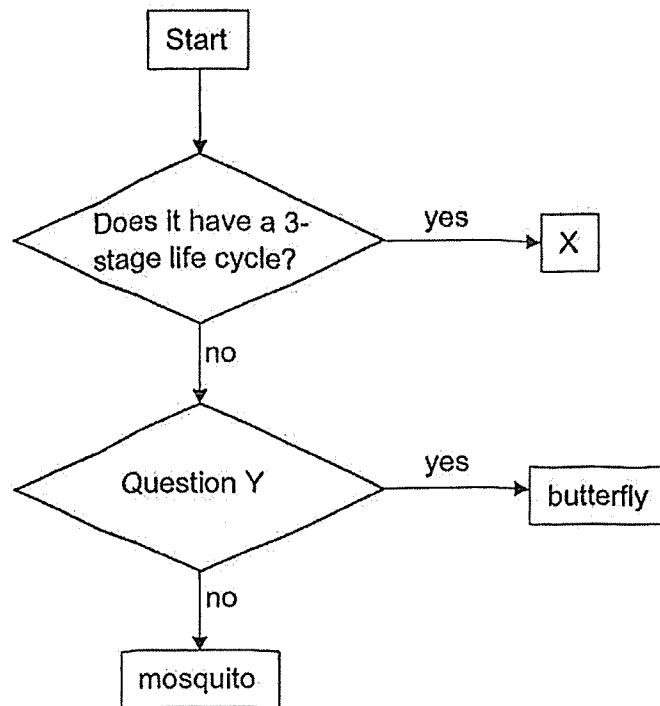

Which of the following correctly shows what organism X and Question Y are?

	X	Question Y
(1)	plant	Does the young live on land?
(2)	frog	Does the young look like the adult?
(3)	cockroach	Does it have a larva stage?
(4)	beetle	Do the adults have wings?

17. The diagram below shows the change of state of water,

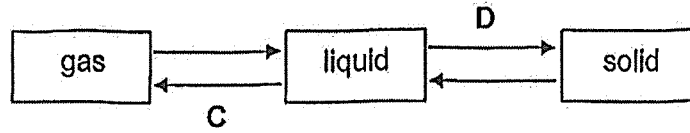

What are processes C and D?

	C	D
(1)	boiling	melting
(2)	evaporation	freezing
(3)	condensation	freezing
(4)	evaporation	condensation

18. The diagram shows a water cycle.

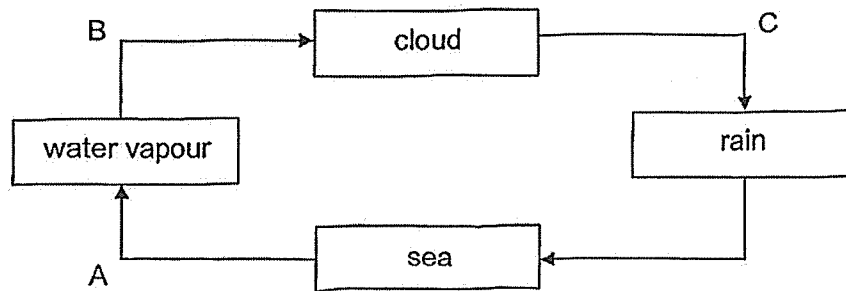

Which process(es) involve(s) water losing heat and changing state?

- (1) A only
- (2) B only
- (3) C only
- (4) B and C only

19. In which of the following circuits will the bulb light up?

(1)

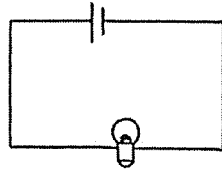

(2)

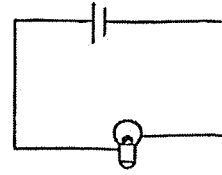

(3)

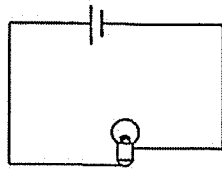

(4)

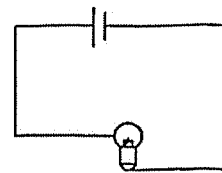

20. A magnet was brought near object Q. It was observed that object Q rolled away from the magnet.

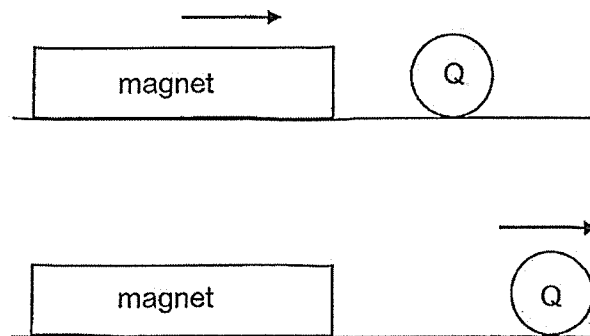

What material is object Q made of?

- (1) iron
- (2) glass
- (3) plastic
- (4) aluminium

21. Study the set-up below.

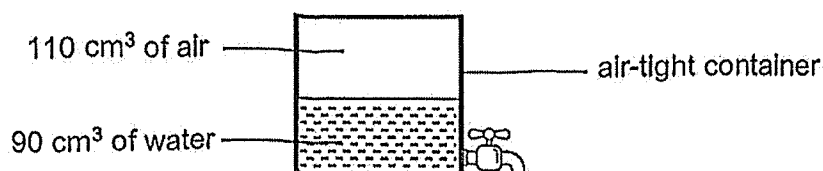

How does the mass and volume of the air in the container change when 20 cm<sup>3</sup> water is removed from the container?

	mass of air	volume of air
(1)	remains the same	remains the same
(2)	remains the same	increases
(3)	increases	remains the same
(4)	increases	increases

22. The table below shows the melting and boiling points of two substances, K and L.

Substance	Melting point (°C)	Boiling point (°C)
K	39	700
L	63	762

Which of the following shows the correct state(s) of K and L at 55°C?

	K	L
(1)	solid	solid
(2)	solid	liquid
(3)	liquid	solid
(4)	liquid	liquid

Use the information below to answer Questions 23 and 24.

Henry added the same amounts of water onto two identical shirts, L and M. He folded shirt L into half and hung both to dry. He measured the mass of each shirt over a few hours.

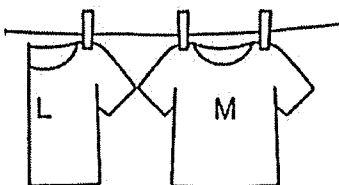

23. What happened to the water in the shirts?

- (1) boiled
- (2) melted
- (3) evaporated
- (4) condensed

24. Which graph correctly shows the change in the masses of shirts L and M over time?

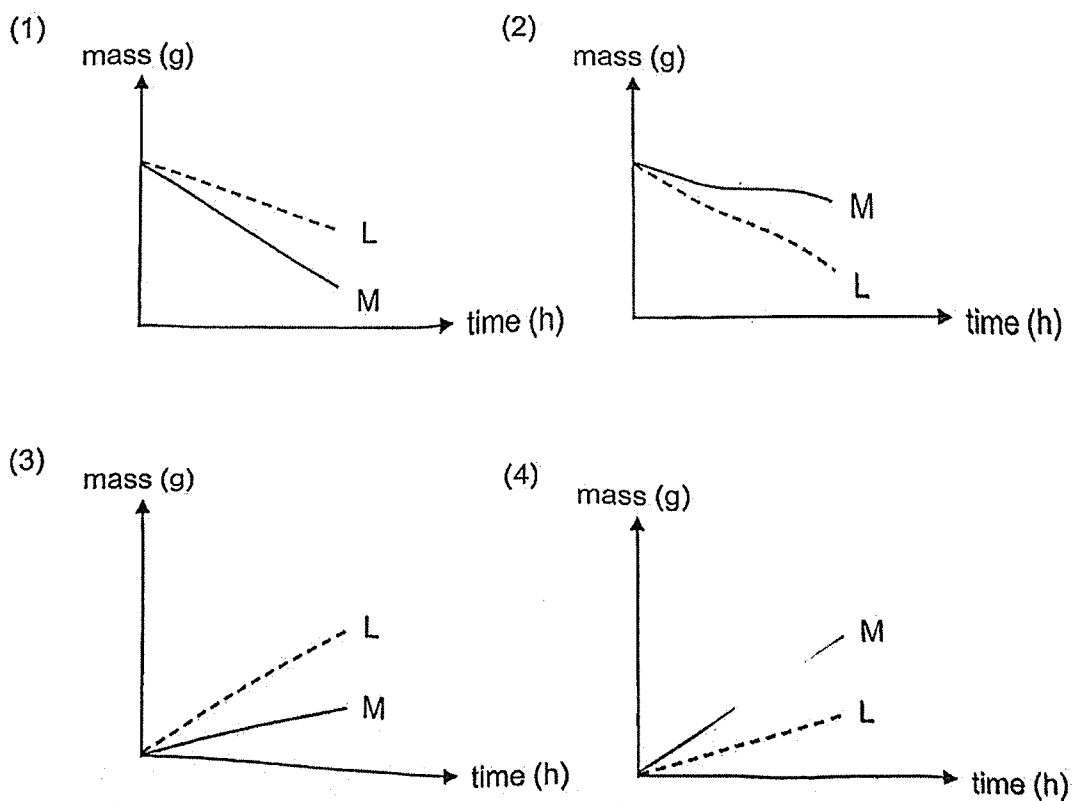

25. A circuit is set up as shown below.

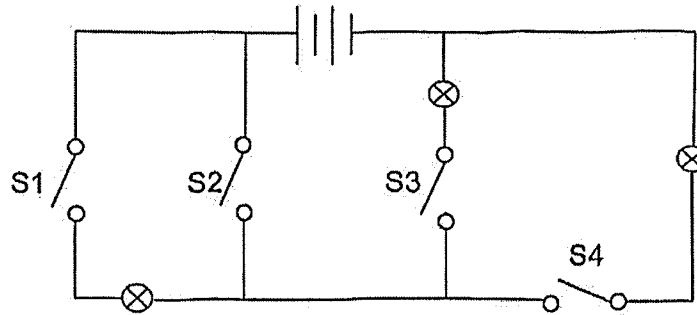

Which two switches should be closed for only one bulb to light up?

- (1) S1 and S2
- (2) S1 and S3
- (3) S2 and S4
- (4) S3 and S4

26. Tom set up four circuits as shown below. Objects P, Q, R and S are made of different materials.

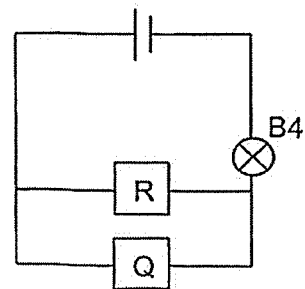
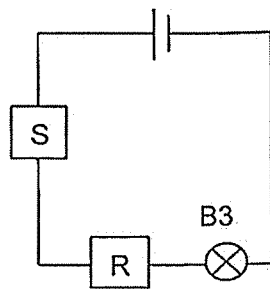
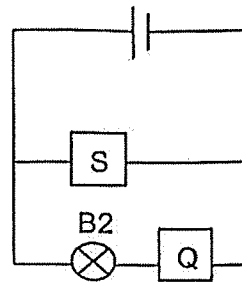
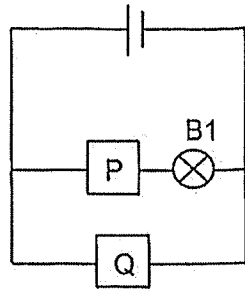

Only bulbs B2 and B4 lit up.

Which of the following correctly shows the properties of objects P, Q, R and S?

	electrical conductor	electrical insulator	unable to tell
(1)	P and Q	R and S	-
(2)	P	Q and S	R
(3)	Q	P	R and S
(4)	P, Q and R	S	

27. The graph below shows how the length of Damien's shadow changed over time as he walked in a straight line under a lamp.

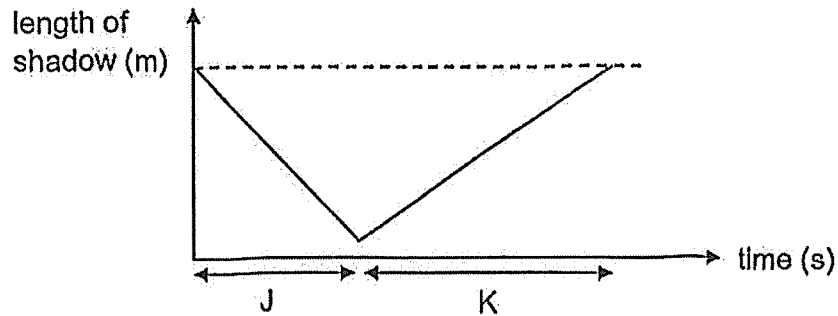

Which of the statements is correct?

- (1) He walked slower during period K as compared to J.
  - (2) He was directly under the lamp at the start and at the end.
  - (3) He walked a shorter distance during period J as compared to K.
  - (4) He was further away from the lamp at the end as compared to at the start.
28. Sammy wanted to find out which material of the rod is the best conductor of heat using the set up below.

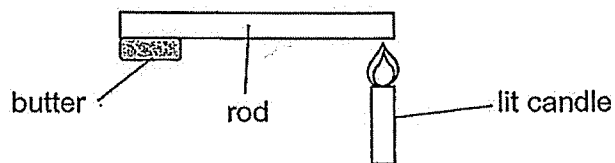

Which of the following correctly identifies the variable to be changed and variable to be measured?

- A. number of lit candles
- B. length of rod
- C. time taken for butter to melt
- D. amount of butter
- E. material of rod

	variable to be changed	variable to be measured
(1)	E	D
(2)	D	B
(3)	A	A
(4)	E	C

29. Harry had two cups with the same amount of water, but the water in each cup was at a different temperature. He placed both cups in a room with a temperature of  $25^{\circ}\text{C}$ . Harry started measuring the temperature of the water in cup B. Then, he poured the water from cup A into cup B and continued to measure the temperature in cup B for one hour.

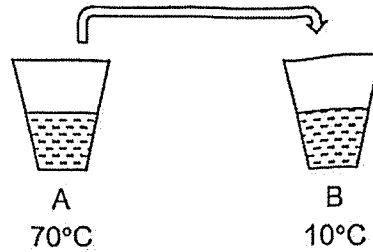

Which of the following graphs shows the change in the temperature of water in cup B?

(1) temperature ( $^{\circ}\text{C}$ )

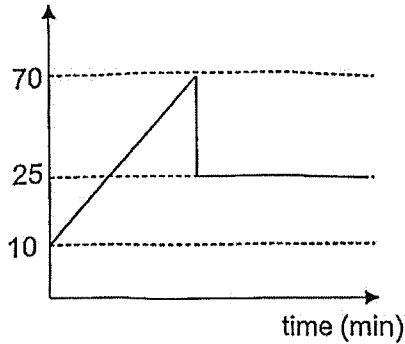

(2) temperature ( $^{\circ}\text{C}$ )

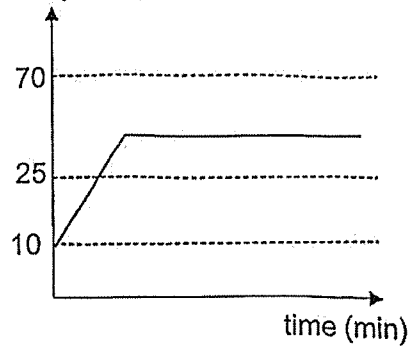

(3) temperature ( $^{\circ}\text{C}$ )

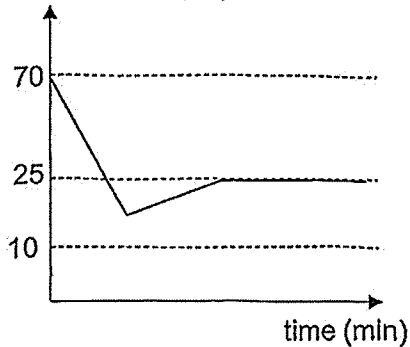

(4) temperature ( $^{\circ}\text{C}$ )

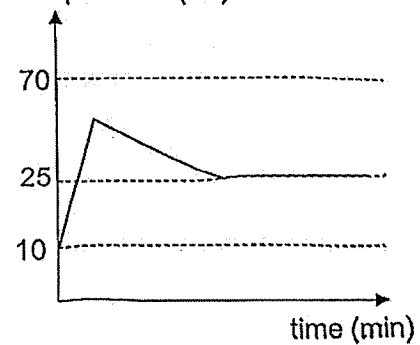

30. Study the flowchart below:

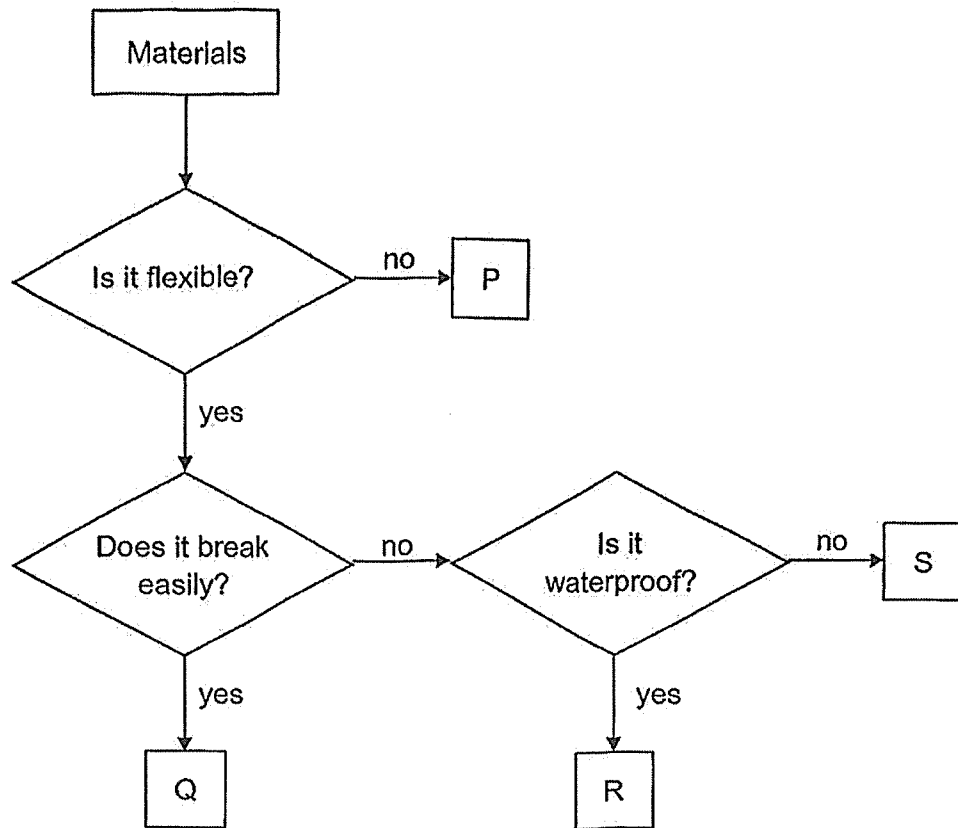

Which material P, Q, R or S would be most suitable for making part X of the mop shown below?

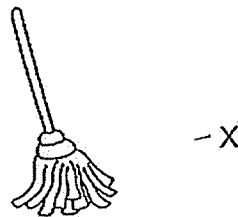

Which material P, Q, R or S would be most suitable for making part X of the mop shown below?

- (1) P
- (2) Q
- (3) R
- (4) S

END OF BOOKLET A

GO ON TO BOOKLET B



MAHA BODHI SCHOOL  
2025 END OF YEAR EXAMINATION  
PRIMARY FIVE SCIENCE  
(BOOKLET B)

Name: \_\_\_\_\_ (      )

Class: Primary 5 \_\_\_\_\_

Date : 27 Oct 2025

Total Duration for Booklets A and B: 1 h 45 min

---

**INSTRUCTIONS TO CANDIDATES:**

1. Do not turn over this page until you are told to do so.
2. Follow all instructions carefully.
3. Answer all questions.
4. Write all your answer in this booklet.

Booklet	Marks Obtained	Max Marks
A		60
B		40
Total		100

Parent's signature: \_\_\_\_\_

This booklet consists of 13 printed pages.

**BLANK PAGE**

**BOOKLET B : [40 marks]**

For questions 31 to 40, write your answers in this booklet.

The number of marks available is shown in the brackets [ ] at the end of each question or part-question.

---

31. Study the diagram of the plant below.

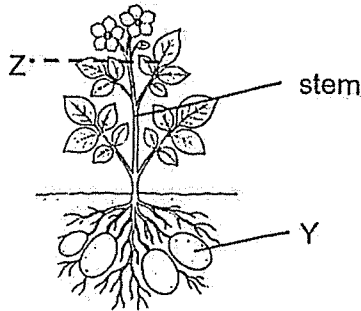

(a) (i) Explain how food is stored in Y. [1]

---

(ii) State one function of the stem. [1]

---

---

(b) A cut is made at Z to remove the food-carrying tubes.

(i) Explain why the flowers cannot survive after some time. [1]

---

---

(ii) Explain why Y can grow bigger after some time. [1]

---

---

Marks : 

/ 4
-----

32. (a) In the table below, identify the part(s) involved in the exchange of gases in a plant and a fish. [1]

(i) plant	
(ii) fish	

Karen filled three tanks, P, Q and R with equal amounts of water but different numbers of plants. She placed the covered tanks under the same lamp in a room.

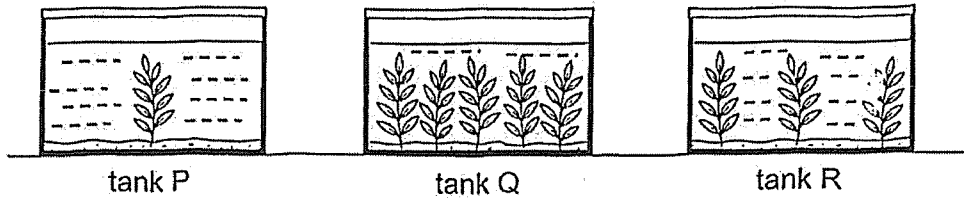

After some time, she measured and recorded the amount of oxygen in the water as shown in the graph below.

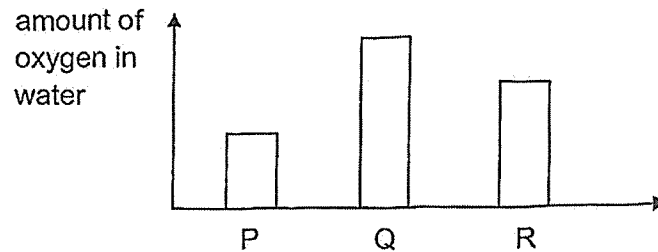

- (b) Based on the above information, what is the relationship between the number of plants and the amount of oxygen in the water over time? [1]

---



---

- (c) She removed all the plants in the three tanks and added 5 fishes into each tank. After some time, in which tank, P, Q or R, will the breathing rate of the fish start to increase first? Explain your answer. [2]

---



---



---

Marks : / 4

33. The diagram below shows a flower Z.

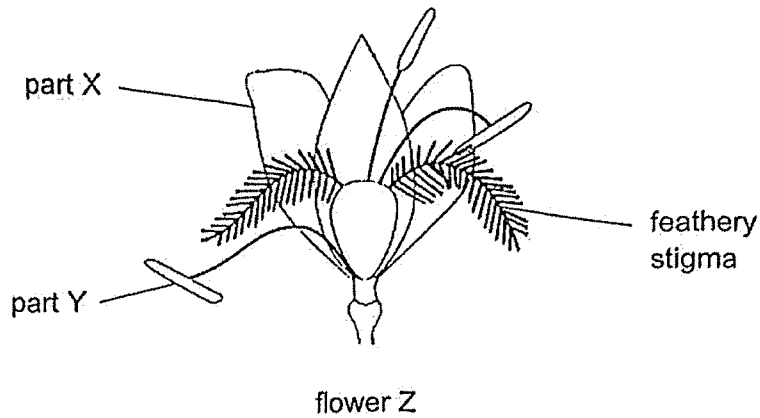

(a) Identify parts X and Y in the diagram above. [1]

(i) Part X

(ii) Part Y

(b) What is the method of pollination for flower Z? [1]

---

(c) Two of the three labelled parts were removed from flower Z. It was still able to develop into a fruit.

Which labelled part of flower Z was not removed? Explain your answer. [2]

---

---

---

Marks :  / 4

34. (a) Jason observed the growth of a seed. He recorded his observations in the table below.

	Day 1	Day 3	Day 5	Day 7	Day 9	Day 11
Height of seedling (cm)	0	1	4	9	14	20
Mass of seed leaf (g)	0.50	0.48	0.30	0.16	0.02	-
Number of green leaves	0	0	0	0	0	2

- (i) State the relationship between the height of the seedling and the mass of the seed leaf. [1]

---

---

- (ii) Explain why the seedling could continue to grow from Day 11 onwards. [1]

---

---

Marks : / 2

34. (b) Study the fruits of plant R and Q below.

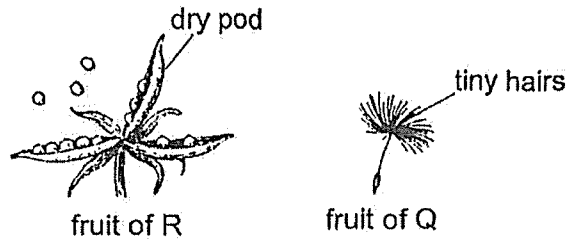

The bars X and Y in the graph below show the number of young plants spotted at different distances from their parent plant in a field.

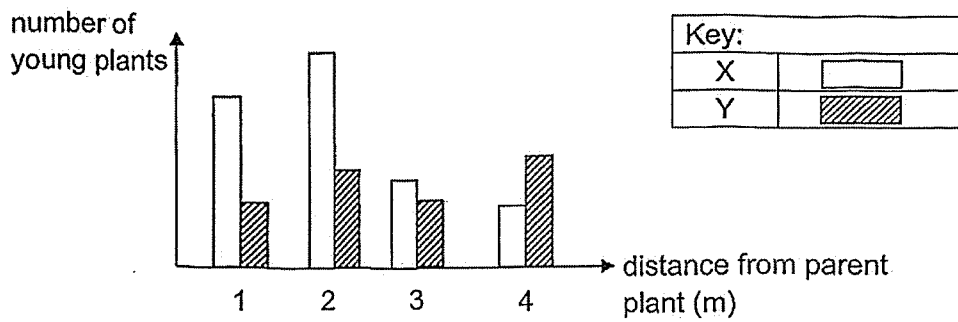

Which plant, R or Q does bars X likely show? Explain your answer. [2]

---



---



---

Marks : / 2

35. Edward placed two identical drink cans, P and Q at different temperatures onto a balance in a room. The temperature of the room was 25°C.

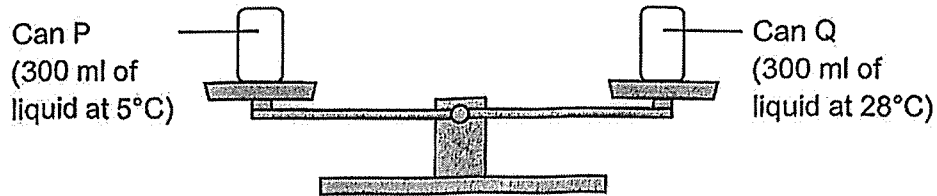

After some time, water droplets started forming onto one of the drink cans. The balance started tilting towards that drink can.

- (a) Which drink can, P or Q, have water droplets forming on it? Explain why the balance tilted towards that drink can. [1]

---



---

- (b) Explain how the water droplets formed on the drink can. [2]

---



---



---

- (c) If Edward left the set-up alone, when will the two drink cans become equal in mass again? [1]

---



---

Marks : 

--

 / 4

36. Gwen conducted an experiment using containers, X, Y and Z, which were made of the same material. She filled them with equal volumes of water and placed the containers next to an open window in the Science room.

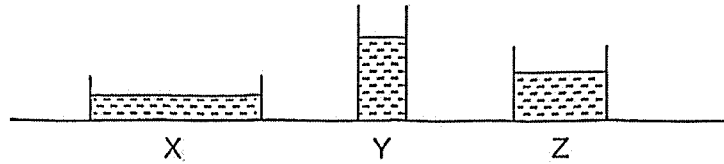

She measured the time taken for the water in each container to evaporate completely.

- (a) Based on the above information, complete the table below with X, Y and Z. [1]

time taken for water to evaporate completely			
shortest $\longrightarrow$ longest			
container			

- (b) Give two reasons why placing all three containers at the same place helps to make the experiment a fair test. [2]

---



---



---

Marks : / 3

37. Lily bought a toy police car which could make a siren sound and the wheels would move when the switch is closed.



- (a) The circuit diagram of the toy car below shows the arrangement of the components after Lily had added two batteries.

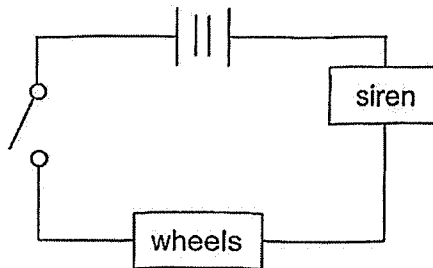

- (i) Give a reason why the wheels did not move and the siren did not make sounds after Lily closed the switch. [1]

---

- (ii) She made some changes to the components in the circuit. The wheels could move and the siren could make sound.

After a while, the siren suddenly stopped making sound. She observed that the wheels also stopped moving although the batteries were still working.

Explain Lily's observation. [2]

---



---



---

Marks : / 3

- (b) Lily decided to set up a new circuit in the toy as shown below. The observations that she wanted to make are described in the table below.

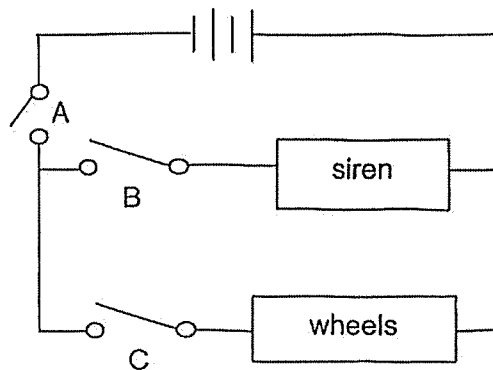

- (i) Which switch(es) should be close for the wheels to move but the siren does not make a sound? [1]

---

- (ii) When all the switches were closed, after some time the wheels stopped moving but the siren still made sound. Explain why. [1]

---

---

Marks : 

/ 2
-----

38. The diagram below shows a container.



(a) Describe how water can be used to find the volume inside the container. [2]

---



---



---

(b) Suggest two properties of water to explain why water is used in (a). [1]

Property 1	
Property 2	

(c) The volume inside the container is  $150 \text{ cm}^3$ . There are 150 similar wooden cubes. Each cube has a volume of  $1 \text{ cm}^3$ .

Explain why all 150 cubes cannot be placed into the empty container. [1]

---



---

Marks : 

--

 / 4

39. The set-up below is used to count sheets of material G.

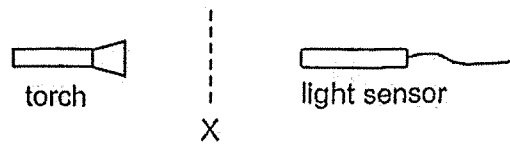

When no sheet is placed at position X, the light sensor shows a reading. A sheet of material G was added to position X every two minutes.

The graph below shows the results of the experiment.

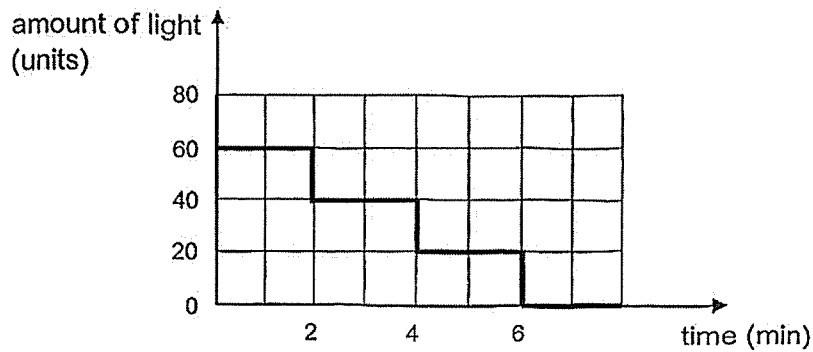

- (a) Based on the results, what was the reading of the light sensor when no sheet of material G was placed at X? [1]
- 
- (b) Based on the results, what was the most number of sheets of material G the set-up could count? [1]
- 
- (c) Based on the above information, what could be concluded about the property of material G? [1]
- 

Marks : / 3

40. (a) What is temperature?

[1]

- (b) Thomas wanted to find out which material allows ice to melt the fastest. He placed similar sized ice cubes in four containers made of different materials W, X, Y and Z and recorded the time taken for the ice cubes to completely melt.

Material	Number of ice cubes	Place where container was placed	Time taken for ice cubes to melt (min)
W	5	classroom	10
X	5	classroom	5
Y	5	fridge	40
Z	3	fridge	25

- (i) What two changes should he make to ensure that his experiment is a fair test? [2]

Change 1:

\_\_\_\_\_

Change 2:

\_\_\_\_\_

Marks : 

/ 3
-----

(b) (ii) After he made the changes, his results are shown below.

Material	Time taken for ice cubes to melt (min)
W	10
X	5
Y	19
Z	13

Based on his results, which material W, X, Y and Z should he choose to make a container to keep food hot the longest? Explain your answer. [2]

---

---

---

Marks : 

12
----

~ END OF PAPER ~



**SCHOOL : MAHA BODHI PRIMARY SCHOOL**  
**LEVEL : PRIMARY 5**  
**SUBJECT : SCIENCE**  
**TERM : 2025 END OF YEAR EXAMINATION**

Q1	Q2	Q3	Q4	Q5	Q6	Q7	Q8	Q9	Q10
2	1	4	2	1	1	4	3	1	2
Q11	Q12	Q13	Q14	Q15	Q16	Q17	Q18	Q19	Q20
4	4	3	3	4	1	2	2	3	1
Q21	Q22	Q23	Q24	Q25	Q26	Q27	Q28	Q29	Q30
2	3	3	1	3	3	1	4	4	4

31(a)(i)	Food made by the leaves is transported through food-carrying tubes to Y.
31(a)(ii)	Any one function: <ul style="list-style-type: none"> <li>• Keeps the plant upright / support the plant</li> <li>• Transports substances to all parts of the plant</li> </ul>
31(b)(i)	Food could not be transported to the flowers.
31(b)(ii)	More food could be transported to Y to be stored.
32(a)	Plant – leaves / stomata / tiny openings Fish – gills
32(b)	<b>Cause / Effect</b> As the number of plants increased the amount of oxygen in the water increased.
32(c)	<b>Claim</b> – Tank P <b>Evidence</b> – It had the least amount of oxygen in the water. <b>Reasoning</b> – Breathing rate increased first so that the fish could have enough oxygen to survive.
33(a)	Part X – petal(s) Part Y – anther(s)
33(b)	Wind pollination
33(c)	<b>Claim</b> – (Feathery) stigma (was not removed) <b>Reasoning</b> – Pollination could still take place and then fertilisation could continue to occur.

34(a)(i)	<b>Cause / Effect</b> As the height of the seedling increased the mass of the seed leaf decreased.
34(a)(ii)	<b>Evidence</b> – Green leaves have grown <b>Reasoning</b> – They can make food for the seedling.
34(b)	<b>Claim</b> – Plant R <b>Evidence</b> – There are more young plants growing nearer to parent plant. <b>Reasoning</b> – Seeds dispersed by splitting would be dispersed nearer to the parent plant as compared to wind.
35(a)	<b>Claim</b> – Can P <b>Reasoning</b> – Water droplets added mass to the can.
35(b)	The (hotter) water vapour touched the cooler drink can. The water vapour lost heat and condensed into water droplets.
35(c)	When all of the water droplets have evaporated.
36(a)	Container: <b>X, Z, Y</b>
36(b)	They would have the same temperature and the same amount of wind.
37(a)(i)	The batteries were placed / arranged wrongly.
37(a)(ii)	<b>Evidence</b> – The siren and wheels were arranged in series. <b>Reasoning</b> – When the siren did not work, there is a gap / an open circuit. Current could not flow through.
37(b)(i)	Switches A and C
37(b)(ii)	<b>Evidence</b> – The siren and the wheels were arranged in parallel. <b>Reasoning</b> – Current can still flow through the wheels (to make them move).
38(a)	Pour water into the container fully / to the brim. Pour into a measuring cylinder to measure the volume of water.
38(b)	Property 1 – Water has a definite volume. Property 2 – Water has no definite shape.
38(c)	The cubes have fixed / definite shape. They cannot occupy the remaining (air) spaces (in the container).
39(a)	60 units
39(b)	2 (If the reading is zero, it could be 3 or more, so maximum is 2)
39(c)	G is translucent / G allows some light to pass through.
40(a)	A measure of how hot or cold an object is.

40(b)(i)	Change 1: Add 2 more ice cubes to Z / Make number of ice cubes to be the same. Change 2: Place Y and Z in the classroom / Place them in the same location / area.
40(b)(ii)	<b>Claim</b> – Y <b>Evidence</b> – The ice cubes took the longest time to melt. <b>Reasoning</b> – Y is poorest conductor of heat / heat flowed through Y the slowest. Hot food will lose heat the slowest to the surroundings.

www.sgexam.com

[www.sgexam.com](http://www.sgexam.com)