

Henry Park Primary School
Primary Five Science
2025 Weighted Assessment 2

Marks: _____ / 25

Name: _____ () Class: 5 __ Parent's Signature: _____

Booklet A (14 marks)

Duration: 30 minutes

For each question from 1 to 7, four options are given. One of them is the correct answer.

Make your choice (1, 2, 3 or 4) and write the answers in the boxes given below.

Q1	Q2	Q3	Q4	Q5	Q6	Q7

1 Bars C, D, E and F were hung on a rod and the observations are shown.

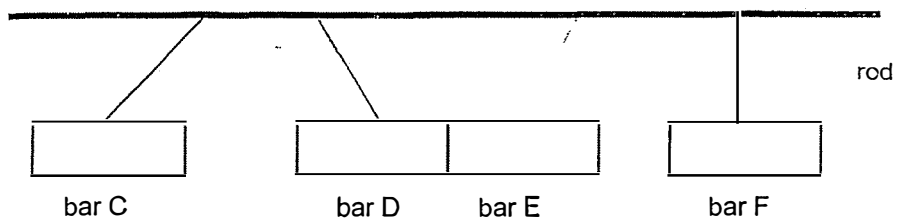

Which one of the following statements is not correct?

- (1) C is a magnet.
- (2) D is made of aluminium.
- (3) E is made of a magnetic material.
- (4) F is made of a non-magnetic material.

- 2 Roy filled two cups, X and Y, with water and covered them with a metal cover. The two cups were placed in a room at 25°C. The diagram below shows what was observed five minutes later.

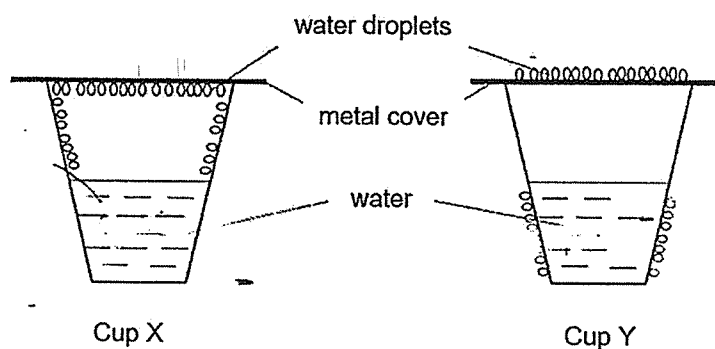

Which of the following is most likely to be the temperatures of the water in Cup X and Y at the start of the experiment?

Temperature of water in (°C)	
Cup X	Cup Y
(1) 80	10
(2) 55	25
(3) 25	10
(4) 10	80

- 3 Four blobs of wax, A, B, C and D, of equal mass were placed at four corners of an iron frame as shown below. The iron frame was heated with a burner at point X.

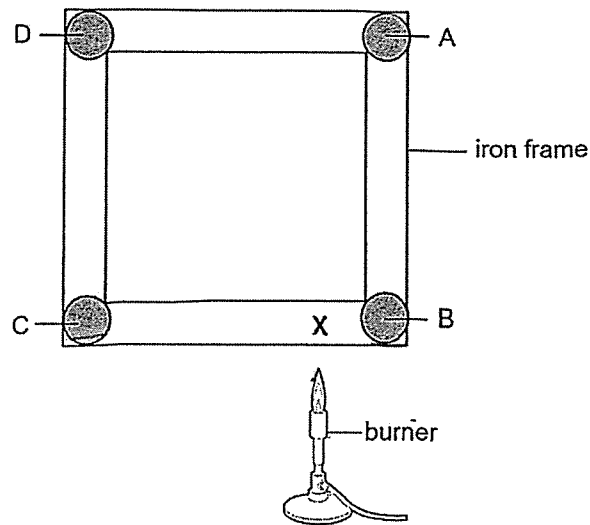

Which one of the following correctly shows the order in which the blobs of wax would melt, starting from the fastest to the slowest?

- (1) B → A → C → D
- (2) B → C → A → D
- (3) C → D → A → B
- (4) C → A → B → D

- 4 Maria set up an experiment to find out how the material of the disc affects the time taken for an ice cube to melt completely. She used two discs made of different materials. She placed an ice cube on each disc as shown below.

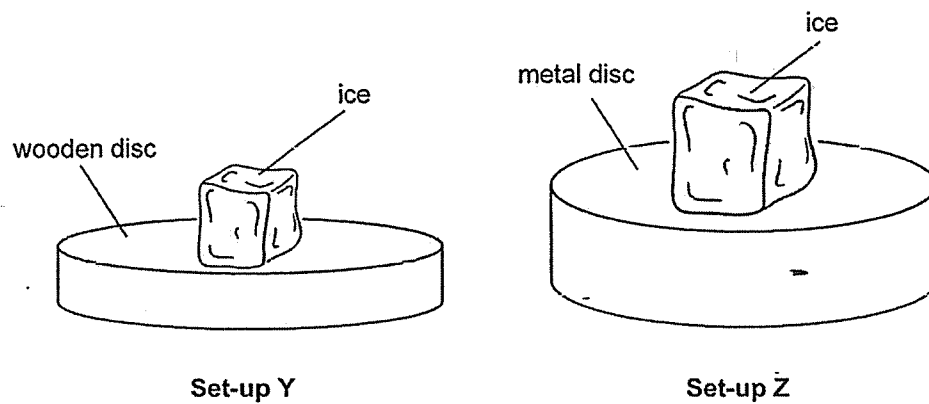

Which of the following suggestions would improve her experiment in order to ensure a fair test?

- A change the metal disc to a wooden disc
 - B keep the size of the ice cubes the same
 - C keep the thickness of the discs the same
- (1) A and B only
(2) B and C only
(3) A and C only
(4) A, B and C

- 5 The diagrams below show the reproductive parts of a flowering plant and a human respectively:

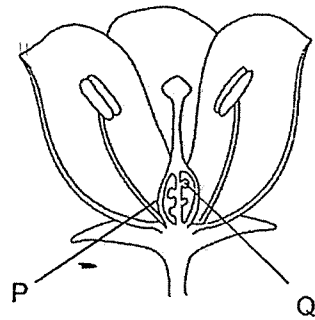

Diagram 1

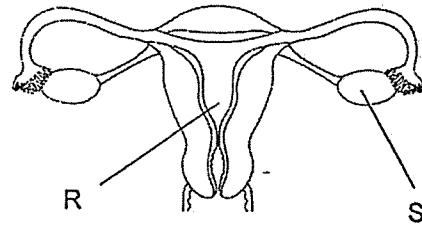
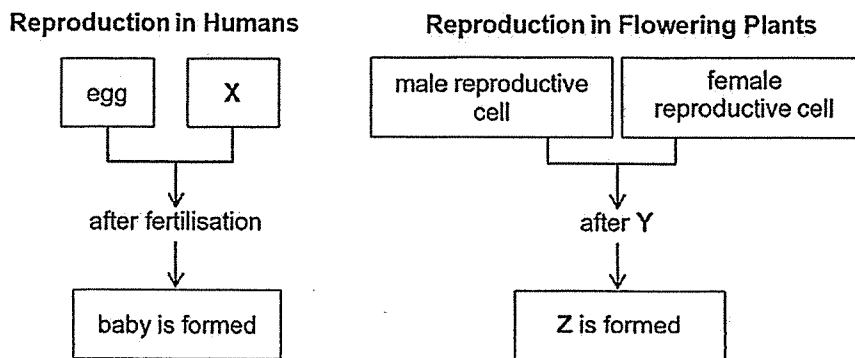

Diagram 2

Which of the following represent the ovaries in diagrams 1 and 2?

- (1) P and R
- (2) P and S
- (3) Q and R
- (4) Q and S

6 The diagram compares sexual reproduction in humans and flowering plants.



What do X, Y and Z represent?

	X	Y	Z
(1)	sperm	pollination	fruit
(2)	testis	pollination	ovary
(3)	sperm	fertilisation	fruit
(4)	testis	fertilisation	seed

7 Study the distribution of seeds by plant P.

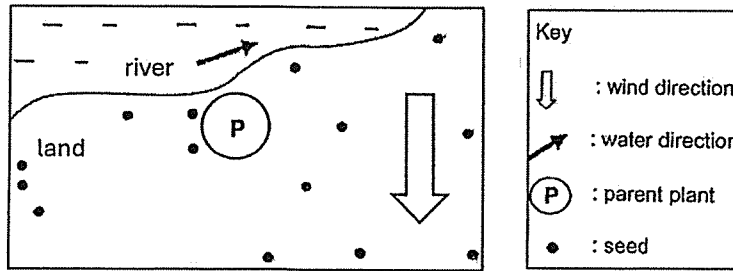

Which of one of the following fruits is produced by plant P?

(1)

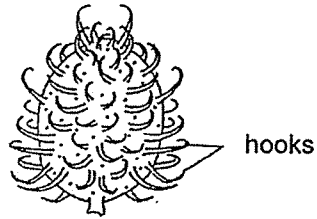

(2)

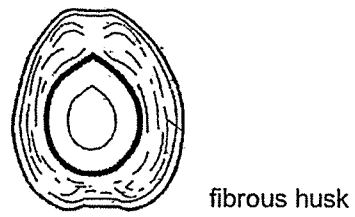

(3)

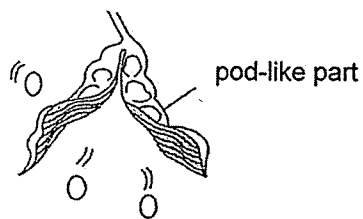

(4)

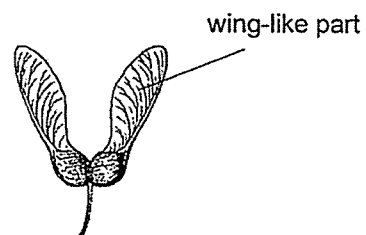

Marks: _____ / 11

Booklet B (11 marks)

For questions 8 to 12, write your answers in the space provided.

The number of marks available is shown in brackets [] at the end of each question or part question.

- 8 Tricia made two holes, W and X, on an empty bottle as shown below.

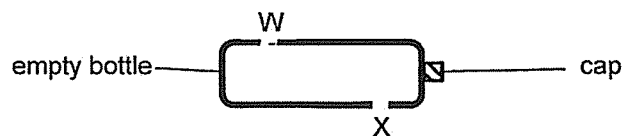

Tricia placed the bottle into a tank of water. After a while, the bottle sank as shown below.

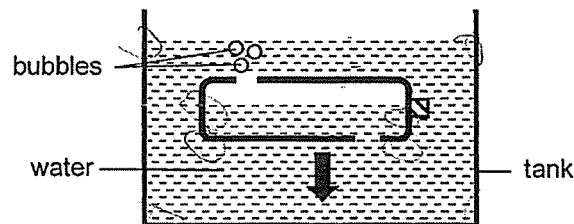

- (a) Explain why the bottle sank after a while. [2]

Tricia observed that the water took both the shape of the bottle and the shape of the tank.

- (b) What can she conclude about the property of water from this observation? [1]

- 9 David hung two identical metal cups, X and Y, from a rod. A lighted candle was then placed directly under cup X as shown below.

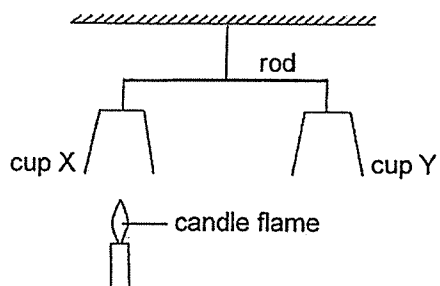

After a few minutes, David observed that the rod moved with cup X moving up and cup Y moving down.

David concluded that cup X moved up because it expanded and became lighter.

- (a) Explain why David's conclusion is wrong. [1]

- (b) Explain what caused cup X to move up. [1]

- 10 Nathan helped his parents wash plates after dinner. He placed the wet plates, one on top of another as shown in figure 1 and left them to dry.

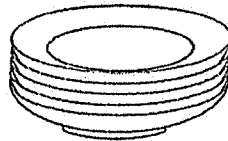

Figure 1

Nathan's sister told him that the plates would dry faster if he placed them on a rack as shown in figure 2.

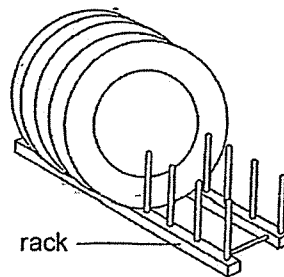

Figure 2

Give 2 reasons why the plates would dry faster than those in figure 1.

[2]

Reason 1:

Reason 2:

11 Rayner observed that magnet G and object H were attracted as shown below.

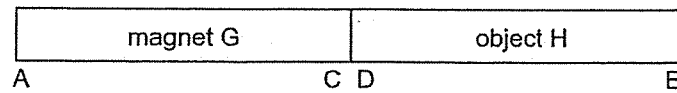



Rayner concluded that object H is definitely a magnet.

(a) Do you agree with him? Give a reason for your answer. [1]

(b) Describe a method that Rayner can use to conclude whether object H is a magnet or not. [1]

12 Param grew some seeds of a plant on four dishes inside the Science lab.

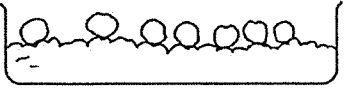
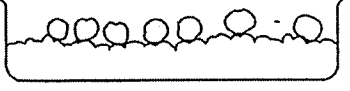
The experimental conditions and results are shown below.

Dish	Soil	Warmth	Presence of Light	Appearance of seeds on Day 4
A	Wet	Yes	No	
B	Wet	No	Yes	
C	Dry	No	Yes	
D	Wet	Yes	No	

(a) Based only on the results shown above, state the condition(s) for germination. [1]

(b) During germination, which part of the seed appears first? [1]

End of Weighted Assessment 2

SCHOOL : HENRY PARK PRIMARY SCHOOL
LEVEL : PRIMARY 5
SUBJECT : SCIENCE
TERM : 2025 WEIGHTED ASSESSMENT 2

Q1	Q2	Q3	Q4	Q5	Q6	Q7			
2	1	2	2	2	3	1			

8a	Water enters through hole X and occupies space in the bottle as air escapes through hole W.
8b	Water has no definite shape.
9a	The mass of the cup will not change when heated.
9b	The surrounding air above the candle flame gained heat and expanded, pushing the cup up.
10a	The exposed surface area of the water is larger in figure 2. The water will evaporate faster.
10b	The water from the plates will flow down in figure 2. There will be less water on the plates to evaporate.
11a	No. Object H could be a magnetic material which would also be attracted to magnet G. OR No. Magnets can both attract and repel other magnets. Since object H is only shown being attracted to magnet G, we cannot tell for sure that H is a magnet.
11b	He can bring end E to end C to see if they repel. OR He can put a magnetic material next to H to see if the magnetic material is attracted to H.
12a	Water and warmth
12b	Roots

www.sgexam.com