



Nan Hua Primary School
Primary 5 Science
Term 3 Weighted Assessment 2025

Marks	
Section A:	/ 10
Section B:	/ 10
Total:	/ 20

Name: _____ ()

Class: Primary 5S _____

Date: _____

Duration: 30 minutes

Parent's Signature

Answer all questions

Section A: (5 x 2 marks = 10 marks)

For each question from 1 to 5, four options are given. One of them is the correct answer. Make your choice (1, 2, 3 or 4) and write your answer in the brackets provided.

- 1 May put a stem with leaves into a beaker of red-coloured water. After one day, she cut the stem. The diagram below shows a cross section of the stem.

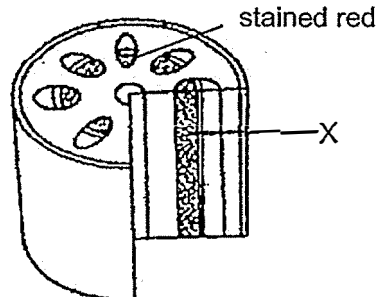

Which one of the following correctly describes part X?

	Substance transported	Carried from	Carried to
(1)	food	leaves	all parts of the plant
(2)	food	stem	leaves
(3)	water	leaves	stem
(4)	water	stem	all parts of the plant

()

2 Which of the following statement is true?

- (1) Gills only transport dissolved oxygen into the blood.
- (2) The lungs and gills are part of the circulatory system.
- (3) Water can be lost through tiny openings found on the leaves.
- (4) Only oxygen in the air enters the lungs during gaseous exchange. ()

3 The diagram below shows how digested food and gases are transported in the human body through systems Q and R. Gases X and Y are exchanged between systems Q and R.

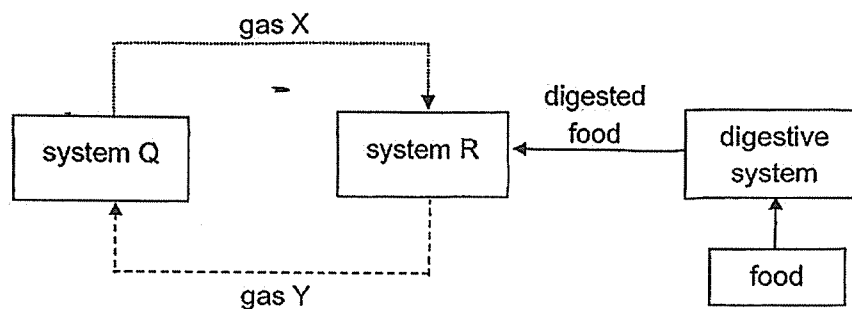

Which of the following best represents system Q, system R, gas X and gas Y?

	System Q	System R	Gas X	Gas Y
(1)	respiratory system	circulatory system	oxygen	carbon dioxide
(2)	circulatory system	respiratory system	carbon dioxide	oxygen
(3)	respiratory system	circulatory system	carbon dioxide	oxygen
(4)	circulatory system	respiratory system	oxygen	carbon dioxide

()

- 4 A group of people was trapped in a lift. The graph below shows the changes in the amount of two different gases, G and H, in the lift.

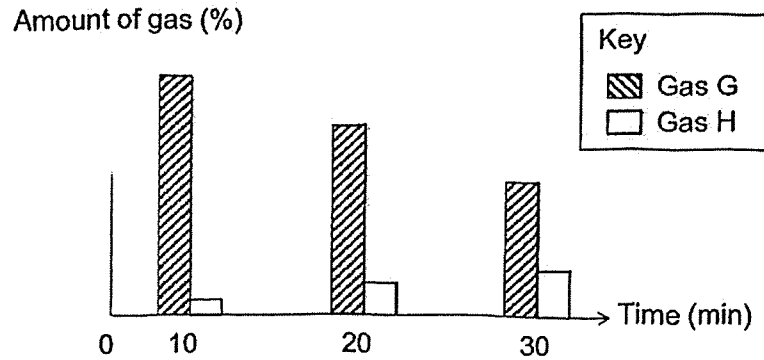

Which one of the following correctly identifies gas G and H?

	Gas G	Gas H
(1)	water vapour	oxygen
(2)	oxygen	nitrogen
(3)	oxygen	carbon dioxide
(4)	nitrogen	water vapour

()

- 5 The graph below shows the change in temperature of a block of melting ice over time.

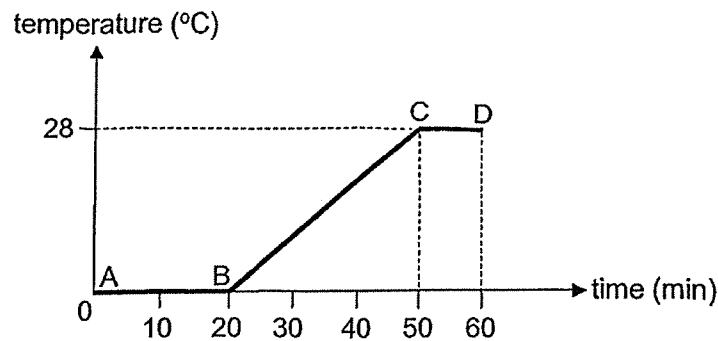

Based on the graph above, which of the following statement is correct?

- (1) There was no evaporation between CD.
- (2) The ice took 50 minutes to melt completely.
- (3) The ice did not lose heat or gain heat between AB.
- (4) The water took 30 minutes to reach 28°C after the ice had melted () completely.

Section B: Structured questions (10 marks)

For questions 6 to 8, write your answers in the space provided. The number of marks available is shown in brackets [] at the end of each question or part question.

- 6 (a) Name three parts found in the human respiratory system. [1]

Kenneth wanted to find out how his average heart rate will change when he walks up the stairs. For the next three days, he walked up five floors of stairs at the same time each day. After each walk, he measured and recorded his heart rate. His resting heart rate is 80 beats per minute (bpm).

Day	Heart rate (bpm)
1	124
2	126
3	120

- (b) Based on the results in the table, how did Kenneth's heart rate change when he walked up the stairs? Explain the change in his heart rate. [2]

SCORE	3
-------	---

- 7 The diagram below shows the movement of substances in the plant transport system. A and B represent different parts of a plant. The arrows show the direction of movement of water or food.

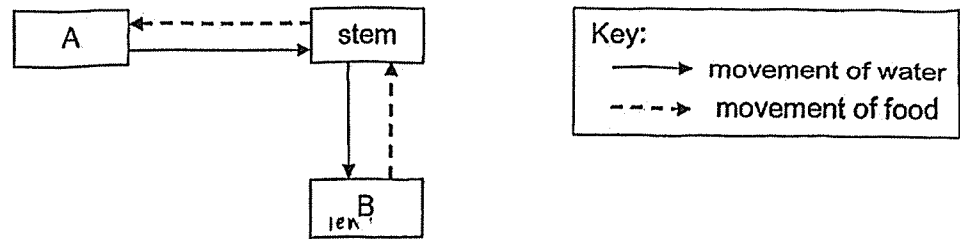

- (a) Identify the parts of the plant that A and B represent in the table below. [2]

	Part of the plant
A	
B	

The diagram below shows a plant with an outer ring of the stem removed. Only the food-carrying tubes were removed.

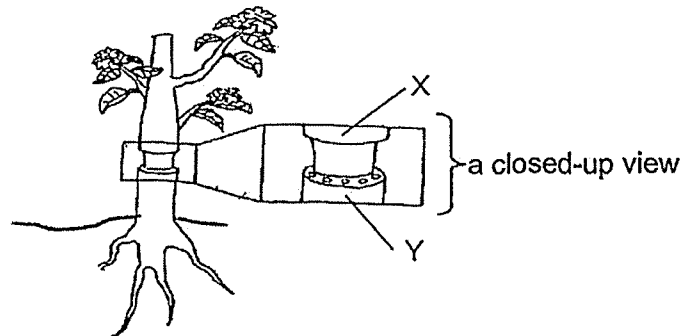

- (b) Which part(s), X and/or Y, of the stem will likely become swollen after some time? [2]
 Explain your answer.

SCORE	4
-------	---

(Go on to the next page)

- 8 Sam set up a bottle garden as shown in the diagram. He poured in some water to ensure that the soil was moist so that his plants would have enough water before covering the bottle. Sam left the bottle garden under the sun for a few hours and noticed that there were some water droplets on the inner wall of the glass bottle.

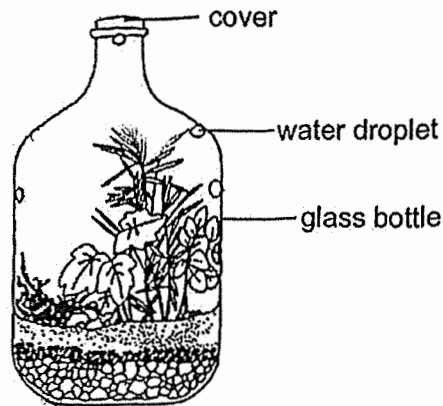

- (a) Explain how the water droplets are formed. [2]

- (b) Sam's teacher told him that he should keep the bottle covered so that he does not need to water the garden for a long time. Explain why. [1]

End of Paper

SCORE	3
-------	---

SCHOOL : NAN HUA PRIMARY SCHOOL
LEVEL : PRIMARY 5
SUBJECT : SCIENCE
TERM : 2025 WEIGHTED ASSESSMENT 3

Q1	Q2	Q3	Q4	Q5					
4	3	1	3	4					

6a	Nose, windpipe, lungs
6b	His heart rate increased. The heart pumps faster to transport blood rich in oxygen, water and digested food to his muscles/legs/all parts of his body faster to release more energy and to remove carbon dioxide faster.
7a	A – root / roots B – leaf / leaves
7b	Part X. Food made in the leaves above the cut cannot be transported downwards to the roots/other parts of the plant and is accumulated/stored at X.
8a	Water in the soil gained heat from the sun and evaporated to form water vapour. The water vapour comes into contact/touches the cooler inner wall of the bottle, lost heat and condenses into water droplets/changes from gas to liquid.
8b	The water droplets flow back into the soil. The process of evaporation and condensation repeats.

www.sgexam.com