

Name : _____ ()

Class : Primary 6 SY / C / G / SE / P

Mathematics Teachers : Mrs Tan / Mrs Lim / Mrs Ong / Ms Wong / Mrs Lee



SINGAPORE CHINESE GIRLS' SCHOOL
PRELIMINARY EXAMINATION

PRIMARY 6

22 Aug 2025

MATHEMATICS
PAPER 1
(BOOKLET A)

Additional materials: Optical Answer Sheet (OAS) Total Time for Booklets A and B: 1 h

INSTRUCTIONS TO CANDIDATES

1. Write your index number in the boxes at the top right-hand corner.
2. Do not turn over this page until you are told to do so.
3. Follow all instructions carefully.
4. Answer all questions.
5. Use a 2B pencil to shade your answers on the Optical Answer Sheet (OAS).
6. The use of calculators is **NOT** allowed.

This booklet consists of 10 printed pages and 0 blank page.

Questions 1 to 10 carry 1 mark each. Questions 11 to 15 carry 2 marks each.
For each question, four options are given. One of them is the correct answer.
Make your choice (1, 2, 3 or 4) and shade your answer on the Optical Answer Sheet.

(20 marks)

1. What is the value of the digit 4 in 347 082?

- (1) 400
- (2) 4000
- (3) 40 000
- (4) 400 000

2. $700 + 40 + 0.5 + 0.004 =$ _____

- (1) 74.540
- (2) 704.504
- (3) 740.504
- (4) 740.540

3. Which of the following is the smallest fraction?

- (1)
- (2)
- (3)
- (4)

4. The figure below shows a trapezium.
Which of the following statements is correct?

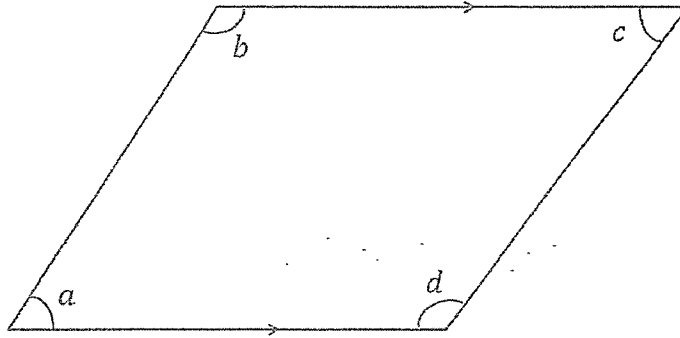

- (1) $\angle b < 90^\circ$
 (2) $\angle a = \angle c$
 (3) $\angle a + \angle b = 180^\circ$
 (4) $\angle a + \angle c > \angle b + \angle d$
5. In the number line, what is the decimal represented by A?

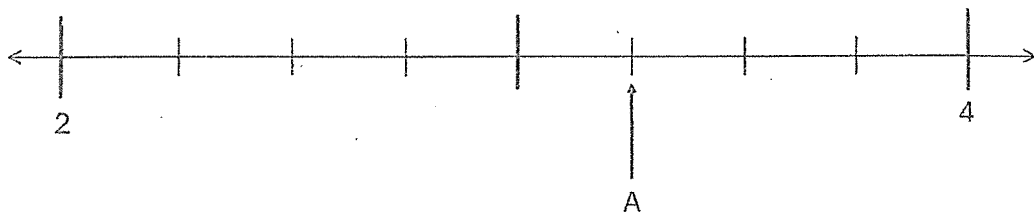

- (1) 2.50
 (2) 2.55
 (3) 3.20
 (4) 3.25

6. In the square grid below, how many shapes have both parallel and perpendicular lines?

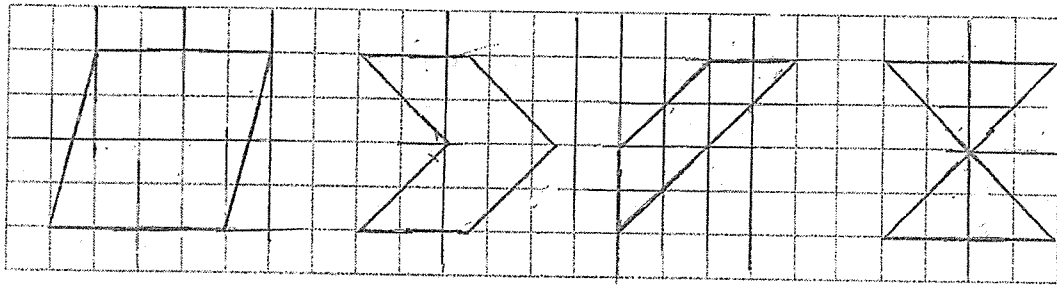

- (1) 1
- (2) 2
- (3) 3
- (4) 0

7. Simplify $20 + 5y + 8 - 2y - 7 + 3$.

- (1) $18 + 3y$
- (2) $18 + 7y$
- (3) $24 + 3y$
- (4) $24 + 7y$

8. Mrs Devi has a piece of square paper as shown below.

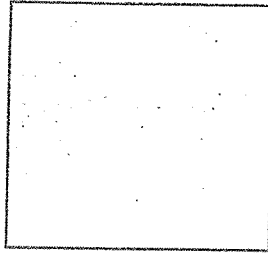

She cut out a new shape from the piece of square paper.

The new shape has the same perimeter as the original square paper.

Which one of the following could be the new shape?

(1)

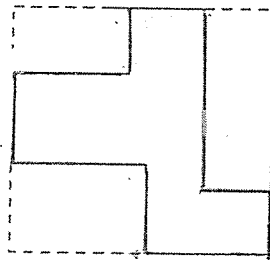

(2)

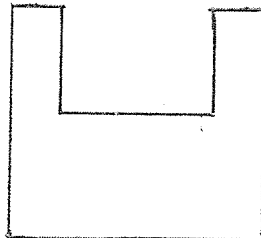

(3)

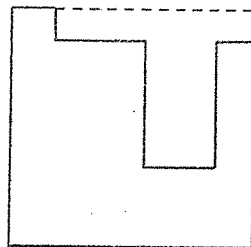

(4)

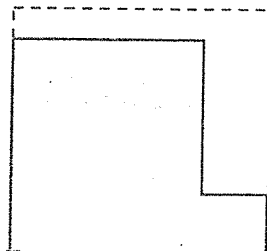

9. The bar graph below shows the number of students participating in CCA activities after school.

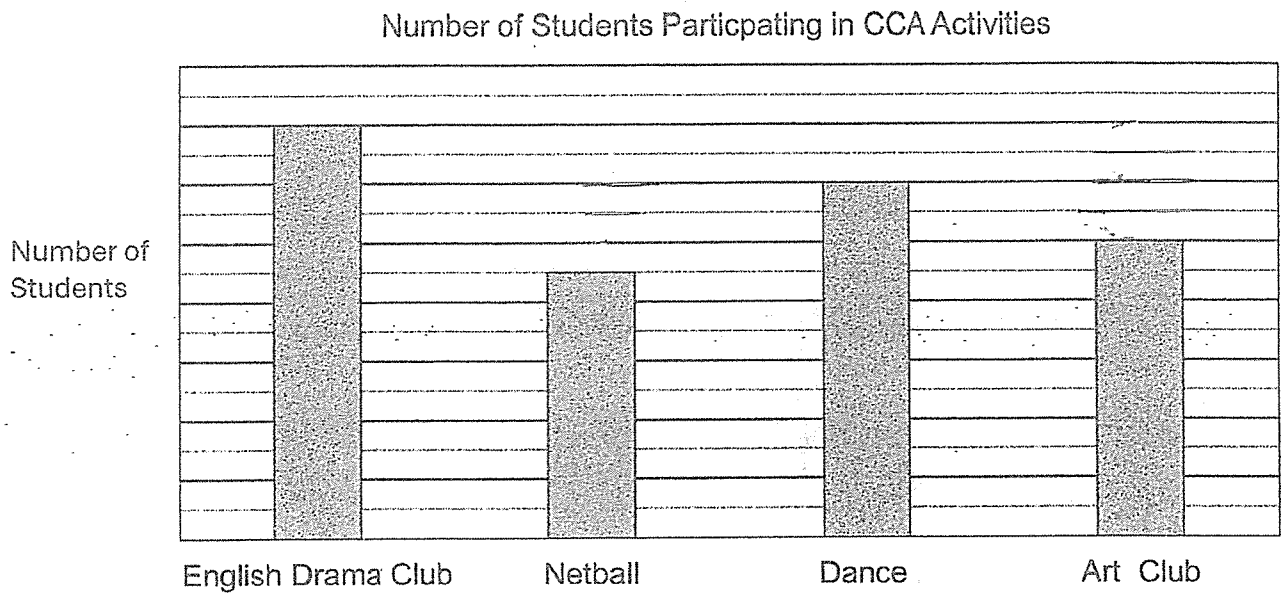

8 more students participated in English Drama Club than in Art Club.

How many more students participated in Dance than in Netball?

- (1) 6
 - (2) 8
 - (3) 3
 - (4) 12
10. Two boxes were placed on a weighing scale. What is the mass of box B in the figure below?

- (1) 4320 g
- (2) 4500 g
- (3) 9000 g
- (4) 9468 g

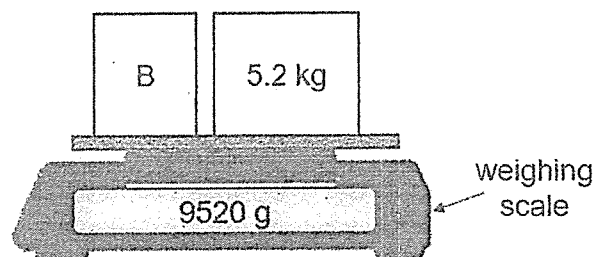

11. The figure below shows a prism.



Which one of the following is a net of the prism?

(1)

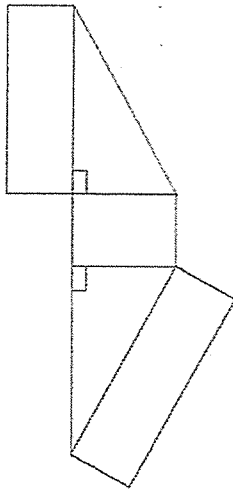

(2)

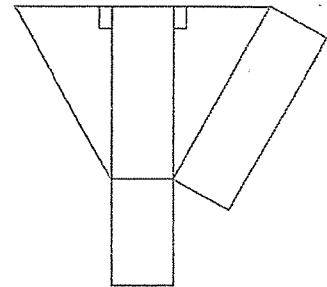

(3)

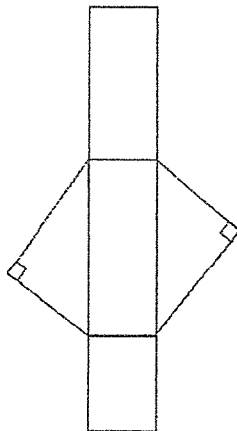

(4)

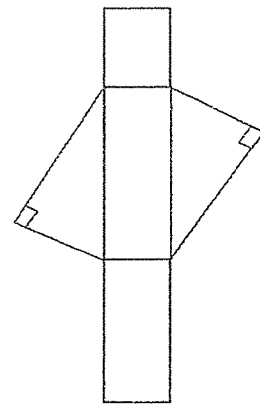

12. A gardener has a plot of land used only for growing vegetables and flowers. In March, 500 m² was used for growing vegetables, and the rest was used for growing flowers. In June, the vegetable plot area increased by 20%, while the flower plot area decreased by 50%. Every part of the land was used for growing either vegetables or flowers, and the total land area remained the same.

Find the total area of the plot of land.

- (1) 100 m²
- (2) 200 m²
- (3) 600 m²
- (4) 700 m²

13. Dora had $\frac{4}{5}$ kg of flour. She used $\frac{1}{2}$ kg to bake a cake and $\frac{1}{6}$ of the remainder to bake cookies. How much flour had she left?

- (1) $\frac{2}{15}$ kg
- (2) $\frac{1}{4}$ kg
- (3) $\frac{1}{3}$ kg
- (4) $\frac{3}{10}$ kg

14. The table below shows the number of different fruits in a basket at first. After 15 rotten apples were removed and 15 oranges were added to the basket, which pie chart best represents the final distribution of fruits in the basket in the end?

Fruit	Number of fruits in a basket at first
Apple	25
Orange	40
Mango	40
Pears	10

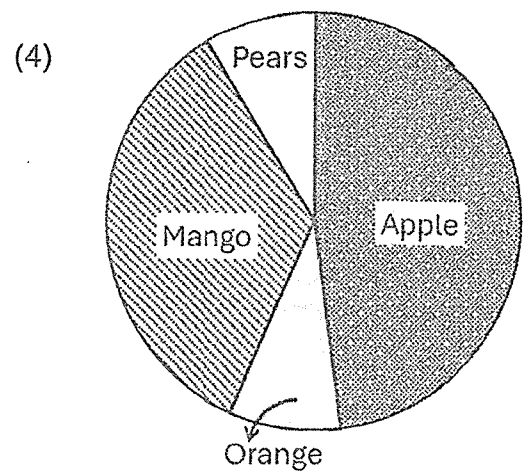
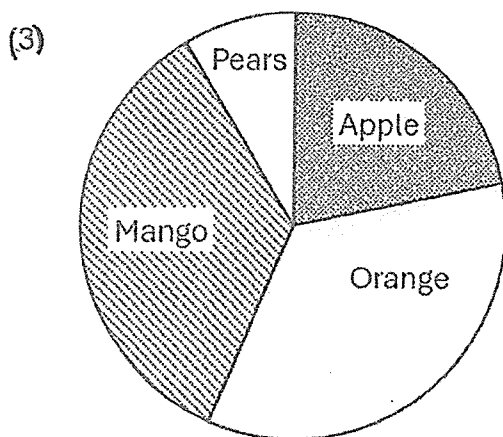
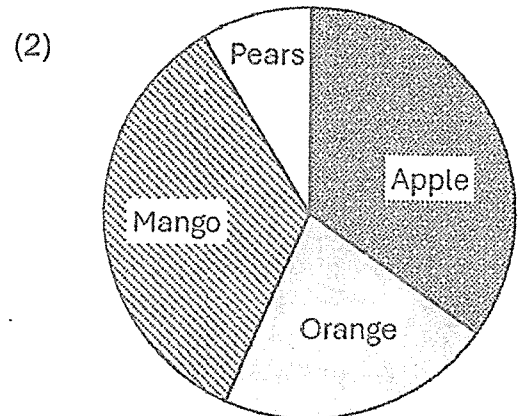
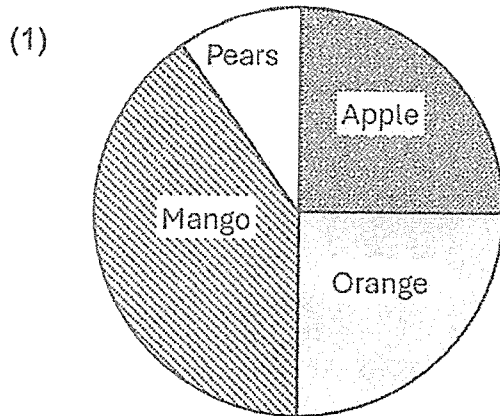

15. The picture below shows a strip of paper with a pattern as shown.
There are 28 shaded rectangles altogether.
What is the greatest possible number of unshaded rectangles I can have in this strip of paper?

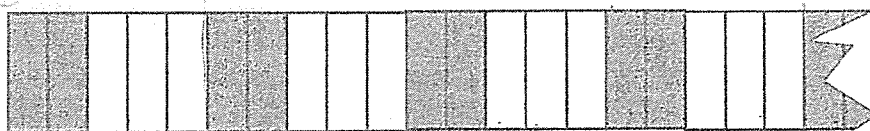

- (1) 15
- (2) 39
- (3) 42
- (4) 45

(Go on to Booklet B)

Name : _____ ()

Class : Primary 6 SY / C / G / SE / P

Mathematics Teachers : Mrs Tan / Mrs Lim / Mrs Ong / Ms Wong / Mrs Lee

	SINGAPORE CHINESE GIRLS' SCHOOL PRELIMINARY EXAMINATION	
	PRIMARY 6	22 Aug 2025
	MATHEMATICS PAPER 1 (BOOKLET B)	
		Total Time for Booklets A and B: 1 h

INSTRUCTIONS TO CANDIDATES

1. Do not turn over this page until you are told to do so.
2. Follow all instructions carefully.
3. Answer all questions.
4. Use a dark blue or black ballpoint pen to write your answers in the space provided for each question.
5. The use of calculators is **NOT** allowed.
6. Do not use correction fluid/tape or highlighters.

	Max Mark	Marks attained
Booklet B	25	

This booklet consists of 9 printed pages and 1 blank page.

Booklet B

Questions 16 to 20 carry 1 mark each. Write your answers in the spaces provided.
For questions which require units, give your answers in the units stated. (5 marks)

16. Write one hundred and six thousand and forty-five in numerals.

Ans: _____

17. Find the value of $9107 \div 7$

Ans: _____

18. Round 81.473 to the nearest hundredth.

Ans: _____

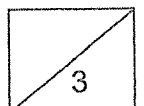

19. Find the value of $\frac{5}{6} \div 10$

Give your answer as a fraction in the simplest form.

Ans: _____

20. The figure below is not drawn to scale. AEB and CED are straight lines.
Find $\angle DEF$.

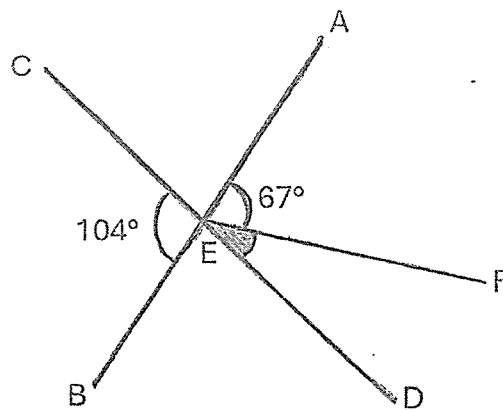

Ans: _____ °

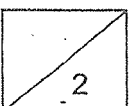

Questions 21 to 30 carry 2 marks each. Show your working clearly and write your answers in the spaces provided. For questions which require units, give your answers in the units stated. (20 marks)

21. The square grid shows the position of the different places in a neighborhood.

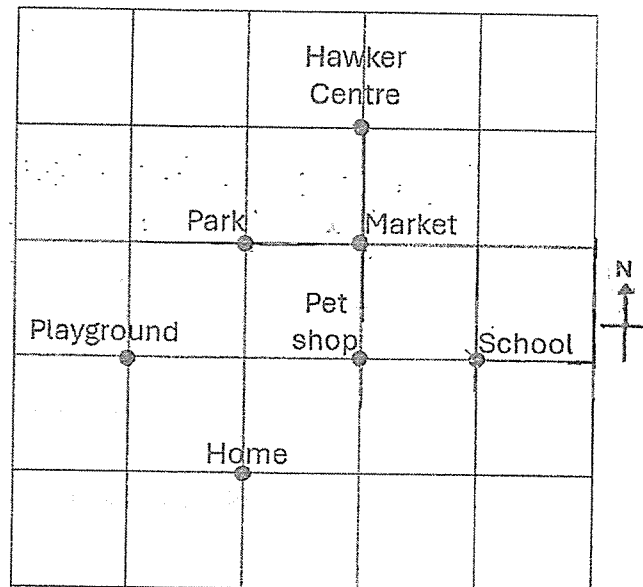

- (a) In which direction is the school from the market?
- (b) Alyssa stood at one of the places facing the hawker centre. After she turned 135° anti-clockwise, she faced the home. Which place was Alyssa at?

Ans: (a) _____

(b) _____

22. A leaking tap drips water. The volume of 4 drops of water is 3 ml of water. If 5 drops of water leaks out of the tap every second, how many ml of water leaks out of the tap in one minute?

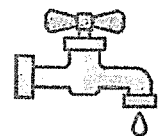

Ans: _____ ml

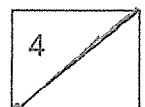

23. The total distance between Town A and Town B is 80 km. At 08 00, a car left Town A for Town B, driving at a constant speed of 90 km/h. At the same time, a bus left Town B for Town A, driving at a constant speed of 60 km/h. At what time would the car and the bus pass each other?

Ans: _____

24. The ratio of the number of beads in Box X to the number of beads in Box Y was 3 : 7 at first. After 35 beads were removed from Box Y, the number of beads in Box X is $\frac{2}{3}$ that of Box Y. How many beads were there in Box X?

Ans: _____

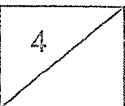

25. To create a symmetric pattern with PQ as the line of symmetry, some squares have already been shaded. What is the minimum number of **additional** squares that need to be shaded to achieve a symmetrical pattern?

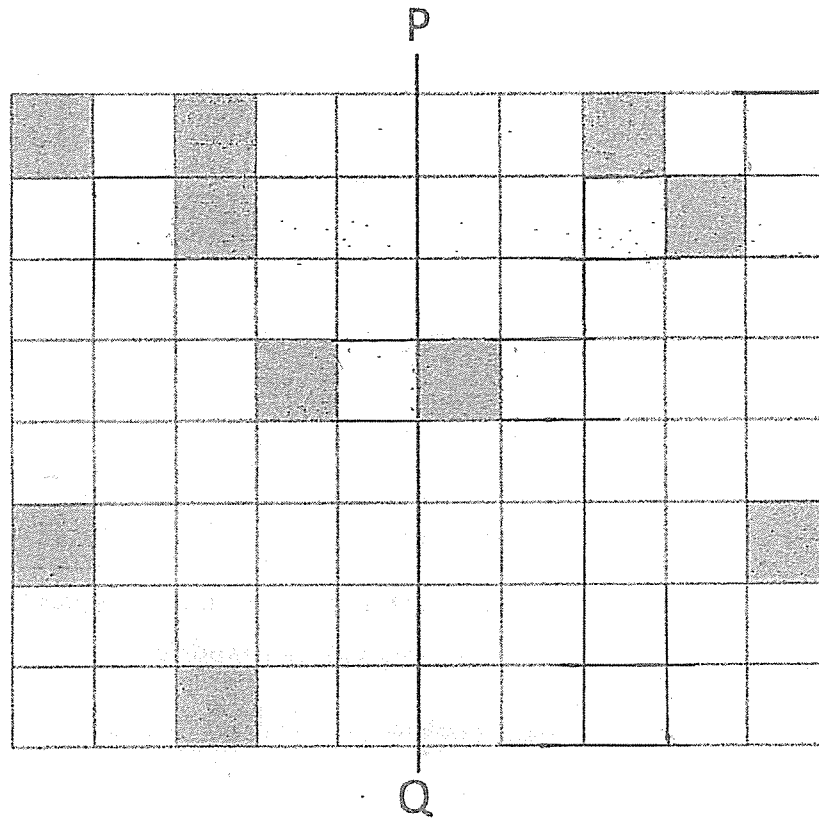

Ans: _____

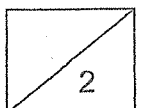

26. There are some cookies in a jar. The cookies can be put into packets of 6 or 8 with no cookies left over. When the cookies are put into packets of 10, there are 2 cookies left over. What is the smallest possible number of cookies in the jar?

Ans: _____

27. The figure below shows a pattern of identical shaded rectangles.

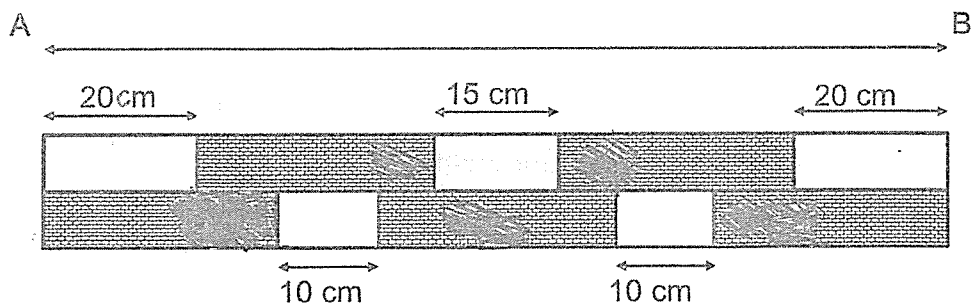

What is the length of AB? (Give your answer in m)

Ans: _____ m

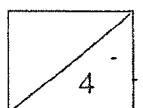

28. The number of boys to the number of girls in a class was 2 : 3. 25% of the boys wear spectacles and 50% of the girls wear spectacles. There were 6 more girls who wear spectacles than boys who wear spectacles. How many boys and girls were there in the class altogether?

Ans: _____

29. There are cats and dogs at a pet shelter. The number of dogs is twice the number of cats. The average age of all the cats is 3 years. The average age of all the dogs is 5 years.

Each statement below is either true, false or not possible to tell from the information given. For each statement, put a tick (✓) in the correct column.

Statement	True	False	Not possible to tell
The average age of all animals at the shelter is 4 years.			
If a new cat that is 6 years old joins the shelter, the average age of cats will increase.			
The oldest dog is older than the youngest cat.			

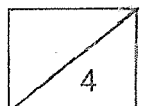

30. The figure below shows two rectangular tanks, X and Y. Water in Tank X was filled to the brim and Tank Y was empty. Water was poured from Tank X into Tank Y such that water level in Tank X was $\frac{1}{2}$ that of Tank Y.

What was the new water level in tank X?

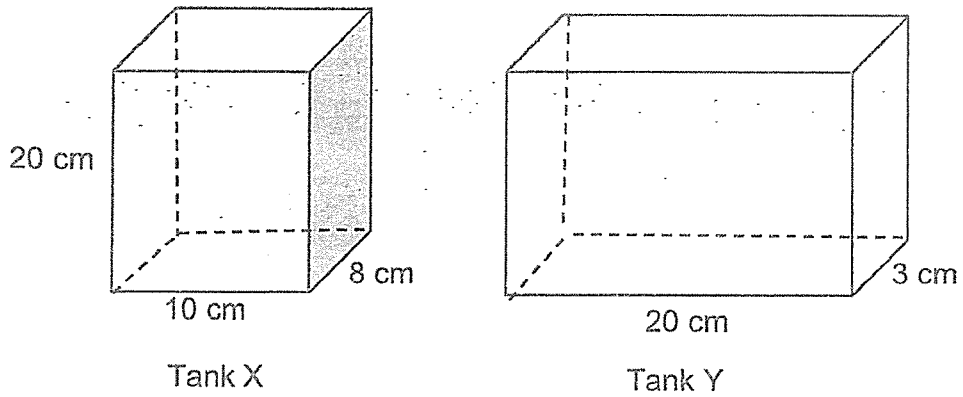

Ans: _____ cm

End of Booklet B

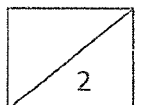

BLANK PAGE

Name : _____ ()

Class : Primary 6 SY / C / G / SE / P

Mathematics Teachers : Mrs Tan / Mrs Lim / Mrs Ong / Ms Wong / Mrs Lee

	SINGAPORE CHINESE GIRLS' SCHOOL PRELIMINARY EXAMINATION	
	PRIMARY 6	22 Aug 2025
	MATHEMATICS PAPER 2	
		Time: 1 hour 30 minutes

INSTRUCTIONS TO CANDIDATES

1. Do not turn over this page until you are told to do so.
2. Follow all instructions carefully.
3. Answer all questions.
4. Use a dark blue or black ballpoint pen to write your answers in the space provided for each question.
5. Do not use correction fluid/tape or highlighters.
6. The use of an approved calculator is allowed.

		Max Mark	Marks attained
Paper 1	Booklet A	20	
	Booklet B	25	
Paper 2		55	
Total Marks		100	

Parent's Signature

This booklet consists of 17 printed pages and 1 blank page.

Questions 1 to 5 carry 2 marks each. Show your working clearly and write your answers in the spaces provided. For questions which require units, give your answers in the units stated. (10 marks)

1. John was fixing a puzzle. The number of pieces he had fixed to the number of pieces he had not fixed was 1 : 3. After fixing another 165 pieces of the puzzle, he had fixed 80% of the puzzle. How many pieces of puzzle were there?

Ans: _____

2. The figure below is made up of 2 quarter circles, a half circle and 2 identical squares. Find the perimeter of the shaded part.

(Take $\pi = \frac{22}{7}$)

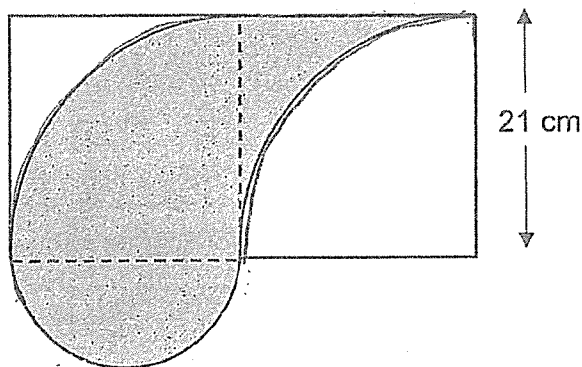

Ans: _____ cm

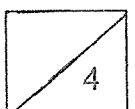

3. Ravindran took $\frac{1}{4}$ h to walk from home to the market. He then increased his speed and took 10 min to walk from the market back to his home. If the distance between his home and the market is 1.2 km, what was his average speed for the whole journey?

Ans: _____ km/h

4. In the figure below, AB is one side of a trapezium, ABCD.
 Draw a trapezium ABCD in the square grid such that $AB = AD$, $BC = \frac{1}{2} AC$ and $\angle ABC = 90^\circ$. Label the trapezium ABCD.

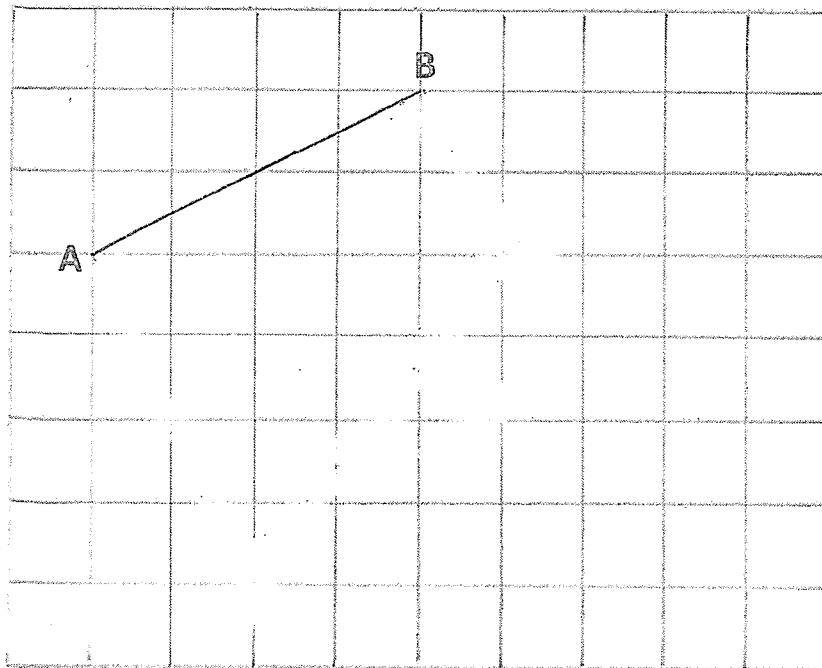

5. A player has to play a total of five games in Round 1 of a competition.
The table below shows Bala's score for his first four games in Round 1.

Game 1	Game 2	Game 3	Game 4	Game 5
15	24	14	20	?

Bala will qualify for Round 2 if his average score for four of the five games is 20 or more.

What is the lowest score Bala must get in Game 5 to qualify for Round 2?

Ans: _____

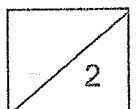

For questions 6 to 17, show your working clearly and write your answers in the spaces provided. The number of marks available is shown in brackets [] at the end of each question or part-question. (45 marks)

6. A jug contained $\frac{5}{6}$ l of fruit tea. A cup had a capacity of $\frac{2}{9}$ l. Jason poured the fruit tea into cups, filling as many cups completely as possible.

- (a) How many cups could Jason fill completely?
- (b) What volume of fruit tea was left? (Give your answer in litres)

Ans: (a) _____ [1]

(b) _____ [2]

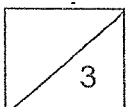

7. Mdm Kamisah bought two dresses with a discount coupon.
The first dress had a 10% discount, and the second dress had a 20% discount.
She paid \$259.42 which includes a GST of 9%.
Both dresses had the same original price before discount.
How much was the original price of each dress (excluding GST)?



Ans: _____ [4]

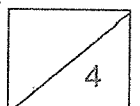

8. The 2 graphs below show the number of students who joined two different Co-Curricular Activities (CCAs), the Robotics Club and the Drama Club, from 2020 to 2024.

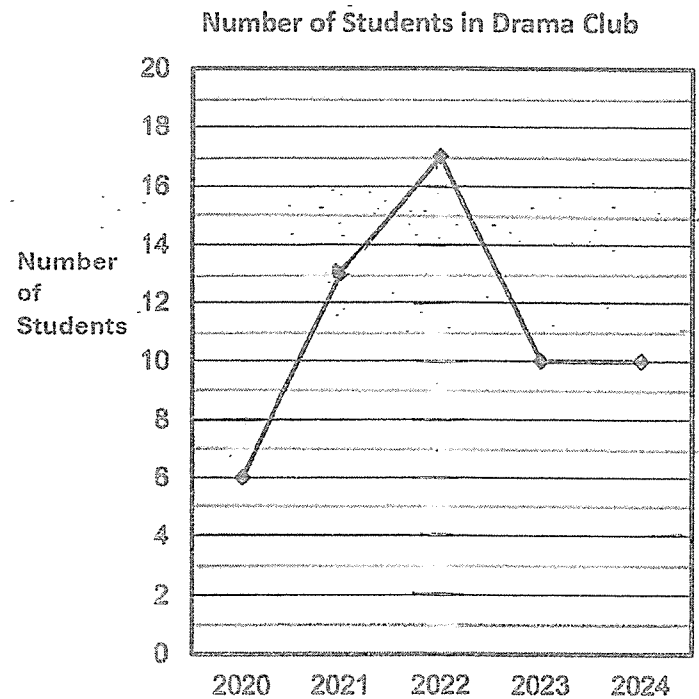
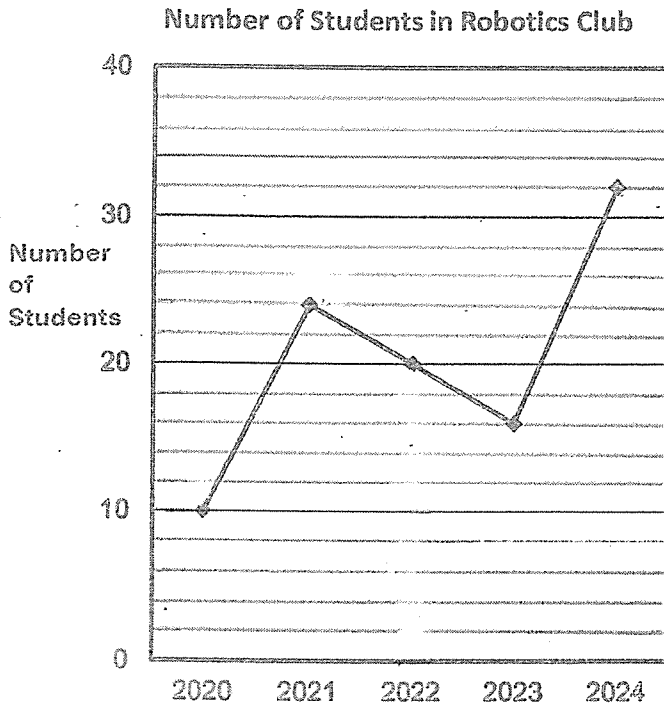

- (a) In 2022, if 3 students left the Drama Club to join the Robotics Club, how many students would each club have?
- (b) Both the Robotics and Drama Club membership increased between 2020 and 2021. Compare this percentage increase. Which CCA had a higher percentage increase?

Ans: (a) Robotics Club : _____

Drama Club : _____ [1]

(b) _____ [2]

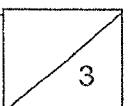

9. The table below shows the prices of admission tickets to Mandai Wildlife Reserve.

Types of ticket	Price (\$)
Child	$3y$
Adult	60
Senior Citizen	$3y - 15$
Family Package (2 adults and 2 children)	$4y + 100$

- (a) A family group consisting of 2 adults, 2 children and 1 senior citizen buy their admission tickets using a family package. How much do they pay? (Express your answer in terms of y)
- (b) The zoo offers a 10% discount off the family package. If $y = \$18$ and the family uses the family package, how much will a family consisting of 2 adults and 2 children pay after the discount?

Ans : (a) _____ [1]

(b) _____ [2]

10a. Michelle stacked her cubes to make the figure as shown below.

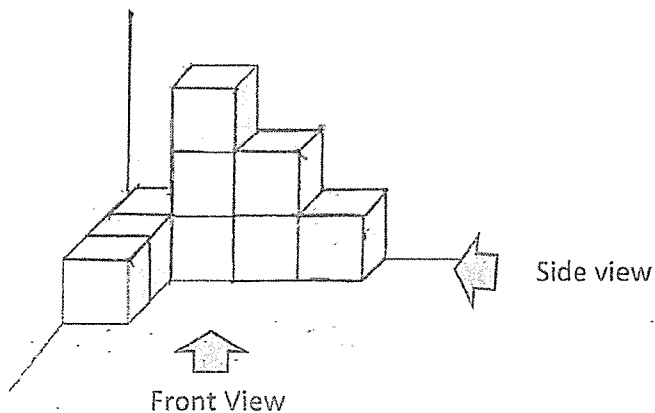

She wants to add more cubes so that her figure matches the view shown below.
What is the minimum number of cubes Michelle needs to add?

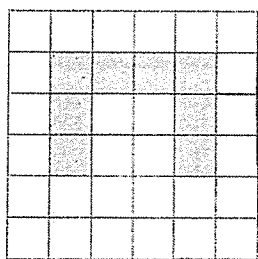

Top View

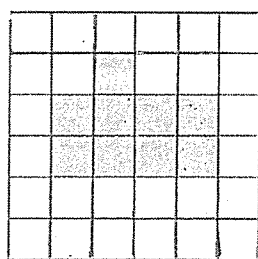

Front View

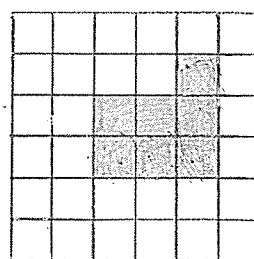

Side View

Ans: (a) _____ [1]

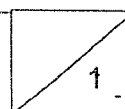

10b, A large water tank contained some water at first. Tap A was turned on to fill up the tank at a rate of 12 l/min. After 6 min, Tap B was also turned on to drain the water at a rate of 8.5 l/min. Both taps continued to turn on for the next 10 min. In the end, there was 165 l of water in the tank.

How much water was in the tank at first?

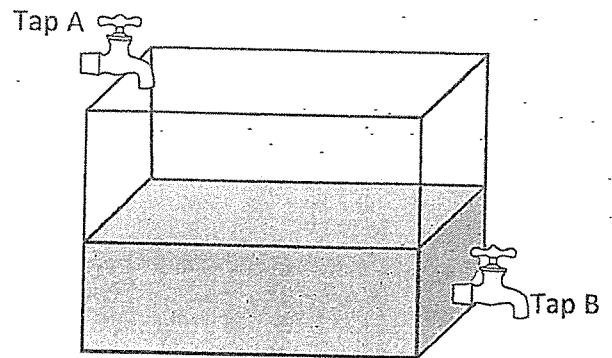

Ans: _____ [3]

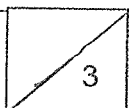

11. The figure below is not drawn to scale. ABCD is a rhombus, CDE is an equilateral triangle and AEDF is a trapezium. Given that $AE \parallel DF$ and $\angle BCE = 42^\circ$, find $\angle BAE$.

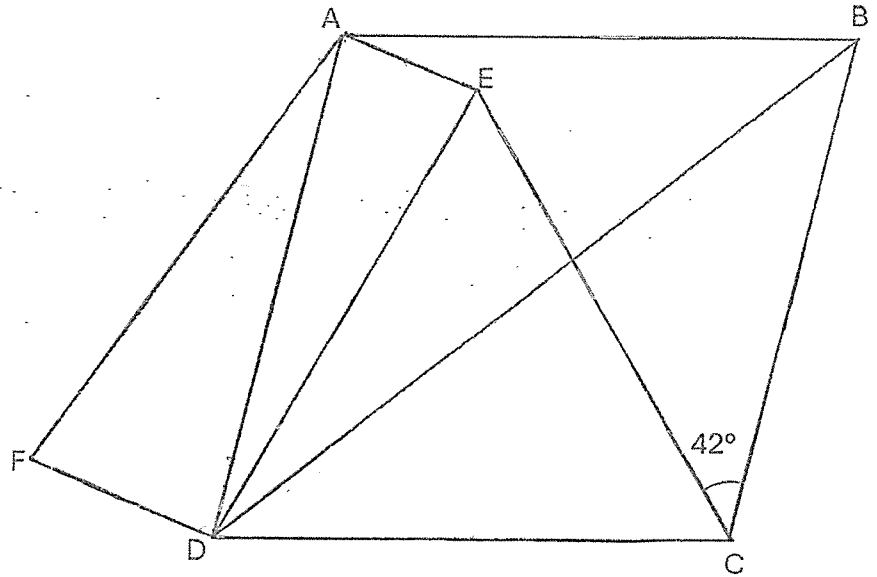

Ans: _____ [3]

12. A string of rectangular lights is being placed along a wall with a total length of 12 m. Each rectangular light is 8 cm wide, and consecutive rectangular lights are each 30 cm apart. The lights must be spaced evenly as shown on the diagram.

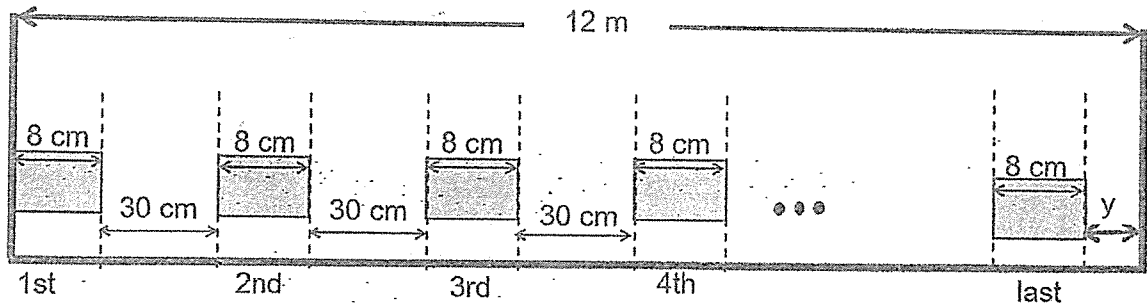

- (a) What is the maximum number of lights that can be placed along this wall?
- (b) What is the distance y , as shown in the diagram?

Ans : (a) _____ [3]

(b) _____ [2]

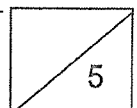

13. The figure is made up of two quarter circles and a rectangle overlapping one another.

The radius of the larger quarter circle is equal to the length of the rectangle.

The radius of the smaller quarter circle is equal to the breadth of the rectangle.

The length of the rectangle is 26 cm, and its breadth is 13 cm.

Find the difference in area between the shaded parts, H and G.

(Take $\pi = 3.14$)

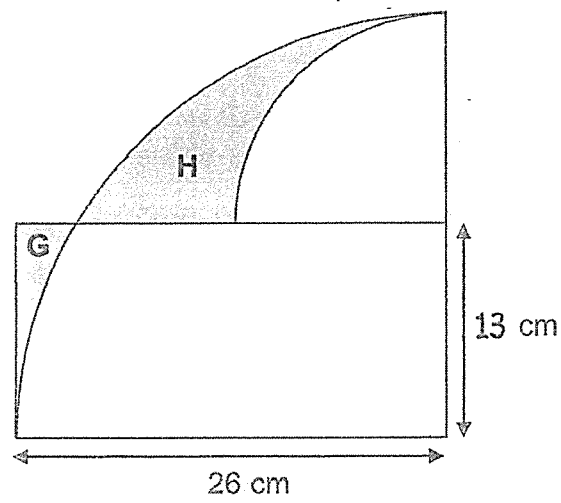

Ans : _____ [3]

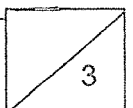

14. A company offered 120 soft toys at a discount of 20% during a 5-day sale. The bar graph shows the number of soft toys left unsold at the end of each day.

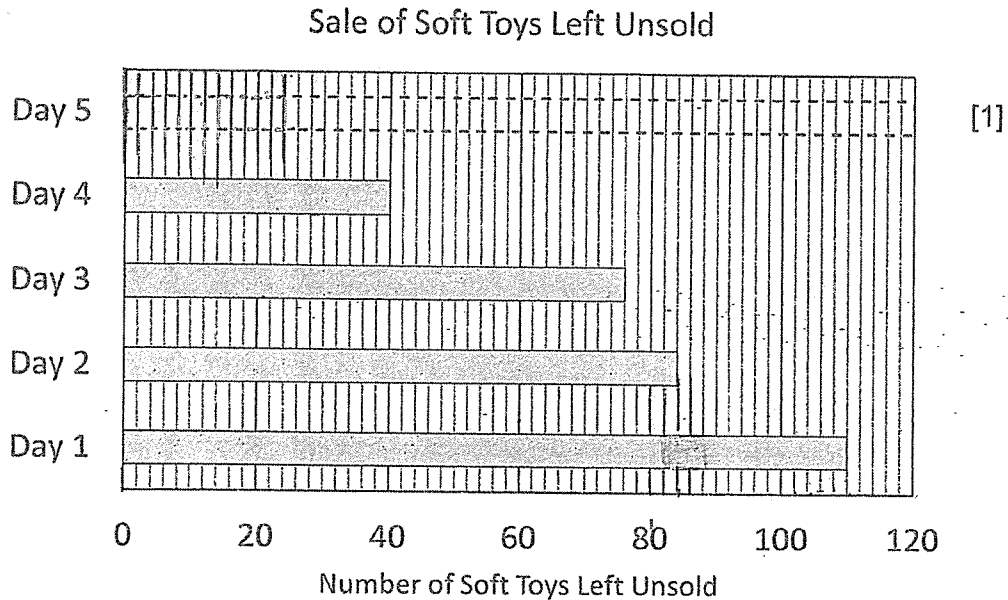

- (a) What fraction of the soft toys were sold in Day 2?
- (b) After the 5-day sales, the ratio of number of soft toys sold to the total number of soft toys was 4 : 5. Draw and shade the bar representing the number of soft toys left unsold on Day 5.
- (c) The usual price of one soft toy was \$80. What was the amount of money collected during the 5-day sale?

Ans: (a) _____ [1]

(c) _____ [2]

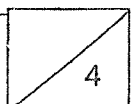

15. The figure below is not drawn to scale. A triangular piece of paper is folded as shown in the figure.

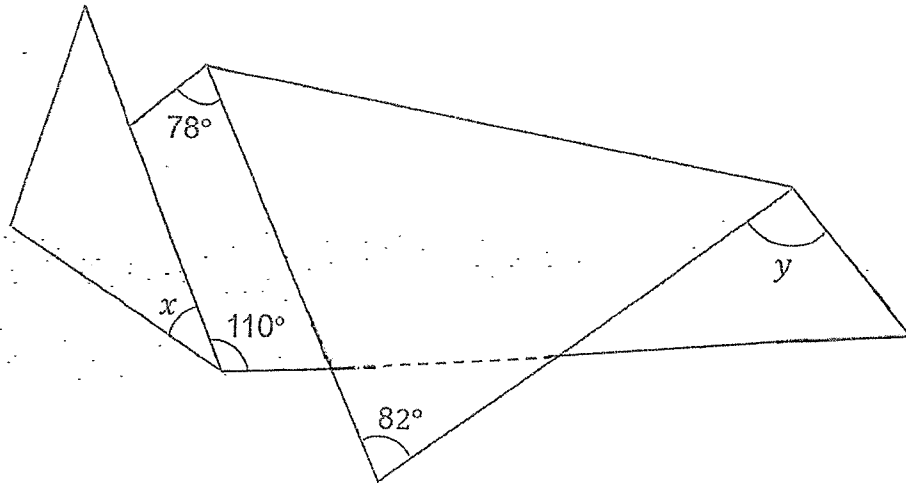

- (a) Find $\angle x$.
(b) Find $\angle y$.

Ans: (a) _____ [1]

(b) _____ [3]

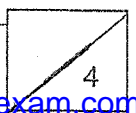

16. Figure 1 shows a rectangle WXYZ with a length of 48 cm. The shaded region in Figure 2 shows the remaining part of the rectangle after 8 identical isosceles triangles were cut out. The perimeter of Figure 2 is 112 cm longer than the perimeter of rectangle WXYZ.

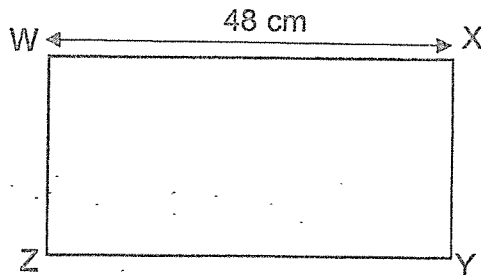

Figure 1

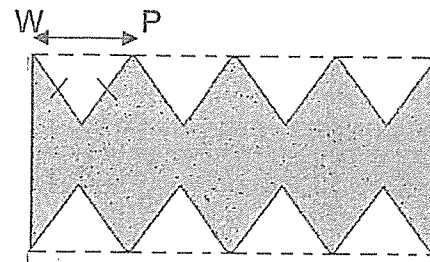
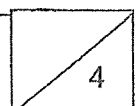

Figure 2

- (a) What was the length of WP?
 (b) What was the perimeter of each isosceles triangle that was cut out?

Ans: (a) _____ [1]

(b) _____ [3]



17. In a bookshop, for every 3 files sold, 1 pencil case was sold.

The total amount collected was \$1176.

The amount collected from files was \$147 more than the amount collected from pencil cases.

Each pencil case was sold for \$3 more than a file.

How many pencil cases were sold?

Ans: _____ [5]

End of Paper 2

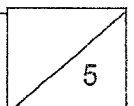

BLANK PAGE

SCHOOL : SINGAPORE CHINESE GIRLS' SCHOOL
LEVEL : PRIMARY 6
SUBJECT : MATHEMATICS
TERM : 2025 PRELIMINARY EXAMINATION

Q1	Q2	Q3	Q4	Q5	Q6	Q7	Q8	Q9	Q10
3	3	4	3	4	2	3	1	1	1
Q11	Q12	Q13	Q14	Q15					
1	4	2	3	3					

Q16	One hundred and six thousand and forty-five in numerals = 106,045
Q17	$9107 \div 7 = 1301$
Q18	$81.473 = 81.47$ (nearest hundredth)
Q19	$\frac{5}{6} \div 10 = \frac{5}{6} \times \frac{1}{10} = \frac{1}{12}$
Q20	$\angle DEF = 104^\circ - 67^\circ = 37^\circ$
Q21	(a) South-East (b) Pet shop
Q22	$60 \times 5 \times \frac{3}{4} = 225$ ml
Q23	Combined speed = $90 + 60 = 150$ km/h Time taken = $80 \div 150 = \frac{8}{15}$ h $= \frac{8}{15} \times 60 = 32$ min 32 minutes after 08 00 is 08 32
Q24	Box X : Box Y Before removal \rightarrow 6:14 After removal \rightarrow 6:9 $14 - 9 = 5$ $35 \div 5 = 7$ $7 \times 6 = 42$ Answer: 42 beads

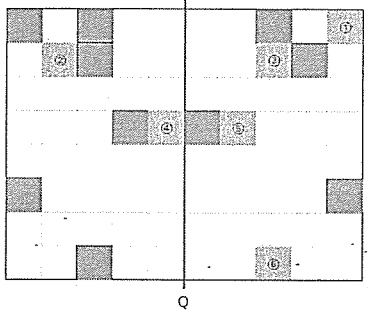
<p>Q25</p>	 <p>Minimum 6 squares are needed as shown in the figure.</p> <p style="text-align: right;">ANS : 6</p>												
<p>Q26</p>	<p>Least common multiple of 6 and 8 is 24. The multiples of 24 are</p> <table border="1" data-bbox="384 779 1310 891"> <tr> <td>Multiples of 24</td> <td>24</td> <td>48</td> <td>72</td> <td>96</td> <td>120</td> </tr> <tr> <td>Reminder when divided by 10</td> <td>4</td> <td>8</td> <td>2</td> <td>6</td> <td>0</td> </tr> </table> <p>So the mallest possible number of cookies is 72.</p> <p style="text-align: right;">ANS : 72</p>	Multiples of 24	24	48	72	96	120	Reminder when divided by 10	4	8	2	6	0
Multiples of 24	24	48	72	96	120								
Reminder when divided by 10	4	8	2	6	0								
<p>Q27</p>	<p>Assume the length of 1 rectangle be u cm. Then, $AB = 2u + 20 + 15 + 20 = 3u + 10 + 10$, $2u + 55 = 3u + 20 \rightarrow u = 55 - 20 = 35$. $\therefore AB = 2 \times 35 + 55 = 70 + 55 = 125 \text{ cm} = 1.25 \text{ m}$.</p> <p style="text-align: right;">ANS : 1.25 m</p>												
<p>Q28</p>	<table border="1" data-bbox="384 1238 1310 1529"> <thead> <tr> <th>Description</th> <th>Boys</th> <th>Girls</th> </tr> </thead> <tbody> <tr> <td>Ratio boys to girls in the class</td> <td>2</td> <td>3</td> </tr> <tr> <td>Percentage of boys / girls wear spectacles</td> <td>25%</td> <td>50%</td> </tr> <tr> <td>Ratio of boys to girls wear spectacles</td> <td>$2(25\%) = 50\% = 0.5$</td> <td>$3(50\%) = 150\% = 1.5$</td> </tr> </tbody> </table> <p>$\therefore 1.5 - 0.5 = 1.0 \rightarrow 6$. $2 + 3 = 5 \rightarrow 5 \times 6 = 30$ students.</p> <p style="text-align: right;">ANS : 30 students</p>	Description	Boys	Girls	Ratio boys to girls in the class	2	3	Percentage of boys / girls wear spectacles	25%	50%	Ratio of boys to girls wear spectacles	$2(25\%) = 50\% = 0.5$	$3(50\%) = 150\% = 1.5$
Description	Boys	Girls											
Ratio boys to girls in the class	2	3											
Percentage of boys / girls wear spectacles	25%	50%											
Ratio of boys to girls wear spectacles	$2(25\%) = 50\% = 0.5$	$3(50\%) = 150\% = 1.5$											

Q29	<p>- Average age of all animals = $\frac{3+2 \times 5}{3} = 4\frac{1}{3}$ years.</p> <p>- A new cat is 6 years old joins the shelter, new average age = $\frac{3n+6}{n+1} > 3$. The new average age of cats has increased.</p> <p>- The oldest dog is older than 5 years, while the youngest cat is younger than 3 years. \therefore The oldest dog is older than the youngest cat.</p> <table border="1" data-bbox="395 660 1326 922"> <thead> <tr> <th>Statement</th> <th>True</th> <th>False</th> <th>Not possible to tell</th> </tr> </thead> <tbody> <tr> <td>The average age of all animals at the shelter is 4 years.</td> <td></td> <td>✓</td> <td></td> </tr> <tr> <td>If a new cat that is 6 years old joins the shelter, the average age of cats will increase.</td> <td>✓</td> <td></td> <td></td> </tr> <tr> <td>The oldest dog is older than the youngest cat.</td> <td>✓</td> <td></td> <td></td> </tr> </tbody> </table>	Statement	True	False	Not possible to tell	The average age of all animals at the shelter is 4 years.		✓		If a new cat that is 6 years old joins the shelter, the average age of cats will increase.	✓			The oldest dog is older than the youngest cat.	✓		
Statement	True	False	Not possible to tell														
The average age of all animals at the shelter is 4 years.		✓															
If a new cat that is 6 years old joins the shelter, the average age of cats will increase.	✓																
The oldest dog is older than the youngest cat.	✓																
Q30	<p>Volume of water = $10 \times 8 \times 20 = 1600 \text{ cm}^3$.</p> <p>If water level in Tank X is u cm, then level in Tank Y is $2u$ cm.</p> <p>Combine volume of water in Tank X and Tank Y</p> <p>= $10 \times 8 \times u + 20 \times 3 \times 2u = 80u + 120u = 200u = 1600$</p> <p>New height of water in Tank X,</p> <p>$u = \frac{1600}{200} = 8 \text{ cm}$. ANS : 8 cm</p>																

PAPER 2

Q1	<p>Percentage of puzzle fixed at first = $\frac{1}{1+3} = \frac{1}{4} \times 100\% = 25\%$</p> <p>$80\% - 25\% = 55\% \rightarrow 165$, $5\% \rightarrow 15$, $100\% \rightarrow 15 \times 20 = 300$.</p> <p style="text-align: right;">ANS : 300</p>
Q2	<p>Perimeter = $21 + \frac{1}{2} \times 2 \times \frac{22}{7} \times 21 + \frac{1}{2} \times 2 \times \frac{22}{7} \times \frac{21}{2}$</p> <p>= $21 + 66 + 33 = 120$. ANS : 120 cm</p>
Q3	<p>Total distance travelled by Ravindran = $2 \times 1.2 = 2.4 \text{ km}$,</p> <p>Total time taken = $\frac{1}{4} \text{ h} + 10 \text{ min} = \frac{1}{4} \text{ h} + \frac{10}{60} \text{ h} = \frac{5}{12} \text{ h}$,</p> <p>Average speed = $2.4 \div \frac{5}{12} = 2.4 \times \frac{12}{5} = 5.76 \text{ km/h}$.</p> <p style="text-align: right;">ANS : 5.76 km/h</p>

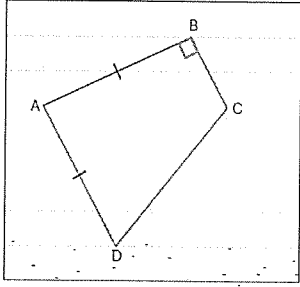
Q4	 <p style="text-align: right;">ANS : See figure</p>
Q5	<p>Total score to qualify for Eound 2 = $20 \times 4 = 80$ Lowest score needed to qualify for Round 2 $= 80 - 24 - 20 - 15 = 21$. ANS : 21</p>
Q6	<p>(a) $\frac{5}{6} \div \frac{2}{9} = \frac{5}{6} \times \frac{9}{2} = \frac{15}{4} = 3\frac{3}{4}$. 3 cups can be filled completely. (b) Volume of fruit left = $\frac{3}{4} \times \frac{2}{9} = \frac{1}{6} l$. ANS : (a) 3 cups (b) $\frac{1}{6} l$</p>
Q7	<p>$100\% - 10\% = 90\%$, $100\% - 20\% = 80\%$, $90\% + 80\% = 170\%$ Total discounted price before GST = $\\$259.42 \div 109\% = \\238 Original price of each dress (excluding GST) $= \\$238 \div 170\% = \\140. ANS : \$140</p>
Q8	<p>(a) Number of students in Robotics Club = $20 + 3 = 23$. Number of students in Drama Club = $17 - 3 = 14$. (b) Robotics Club membership increased = $\frac{24-10}{10} = 140\%$. Drama Club membership increased = $\frac{13-6}{6} = 116\frac{2}{3}\%$. ANS : (a) Robotics Club = 23 Drama Club = 14 (b) Robotics Club</p>
Q9	<p>(a) Fee paid = $\\$(4y + 100) + \\$(3y - 15) = \\$(7y + 85)$. (b) $y = \\$18$, total fee = $\\$(4y + 100) = \\$(4 \times 18 + 100) = \\$172$. Discounted price = $\\$172 \times 90\% = \\154.80. ANS : (a) $\\$(7y + 85)$ (b) \$154.80</p>

<p>Q10</p>	<p>(a)</p> <p>Minimum number of cubes needs to add to have the above top view, front view and side view are as shown in the upper right figure.</p> <p>(b) Net inflow of water into the tank $= 12 \times (6 + 10) - 8.5 \times 10 = 107 \text{ l}$, Water in the tank at first $= 165 - 107 = 58 \text{ l}$.</p> <p style="text-align: right;">ANS : (a) 4 (b) 58 l</p>
<p>Q11</p>	<p>From $\triangle CDE$, $\angle CDE = \angle DCE = 60^\circ$. From rhombus ABCD, $\angle ADE = 180^\circ - 60^\circ - 60^\circ - 42^\circ = 18^\circ$, and $\angle BAD = \angle BCD = 60^\circ + 42^\circ = 102^\circ$. From $\triangle ADE$, $\angle DAE = (180^\circ - 18^\circ) \div 2 = 81^\circ$, Thus, $\angle BAE = 102^\circ - 81^\circ = 21^\circ$.</p> <p style="text-align: right;">ANS : 21°</p>
<p>Q12</p>	<p>(a) $12 \text{ m} = 1200 \text{ cm}$, $8 + 30 = 38 \text{ cm}$, $1200 \div 38 = 31 \text{ R } 22 \text{ cm}$, $22 \text{ cm} = (8 + 14) \text{ cm}$. Maximum number of lights can be placed $= 31 + 1 = 32$. (b) $y = 22 - 8 = 14 \text{ cm}$.</p> <p style="text-align: right;">ANS : (a) 32 (b) 14 cm</p>

Q13

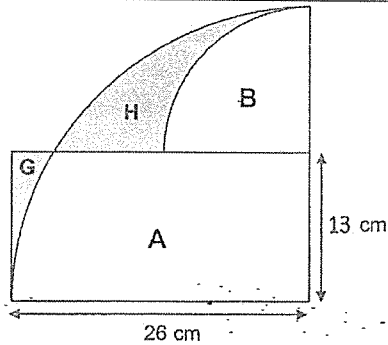

Denote area of shaded part H = [H], then,
 $[H] - [G] = ([H] + [B] + [A]) - ([G] + [B] + [A])$
 $= ([H] + [B] + [A]) - ([G] + [A]) - [B]$
 $= [\text{Big quarter circle of radius } 26 \text{ cm}] - [\text{Rectangle}] -$
 $[\text{small quarter circle of radius } 13 \text{ cm}]$
 $= 0.25 \times 3.14 \times 26^2 - 26 \times 13 - 0.25 \times 3.14 \times 13^2$
 $= 59.995 \text{ cm}^2$

ANS : 59.995 cm²

Q14

(a) Soft toys sold in Day 2 = 110 - 84 = 26.

$$\text{Fraction of soft toys sold in Day 2} = \frac{26}{120} = \frac{13}{60}$$

(b) Number of soft toys left unsold in Day 5 = $\frac{1}{5} \times 120 = 24$.

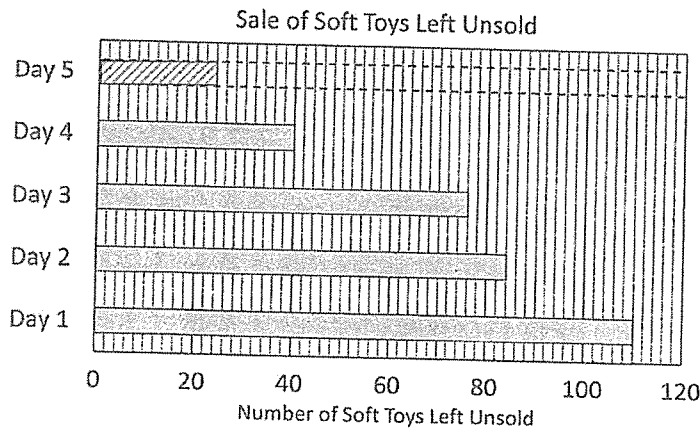

(c) 120 - 24 = 96,

Amount of money collected during the 5-day sale
 $= 96 \times \$80 \times 80\% = \6144 .

ANS : (a) $\frac{13}{60}$

(b) See figure

(c) \$6144

Q15	<p>(a) $\angle x = (180^\circ - 110^\circ) \div 2 = 70^\circ \div 2 = 35^\circ$</p> <p>(b) $(180^\circ - 78^\circ) \div 2 = 102^\circ \div 2 = 51^\circ$ $180^\circ - 82^\circ - 51^\circ = 47^\circ$ $\therefore \angle x = 180^\circ - 47^\circ - 47^\circ = 86^\circ$</p>
Q16	<p>(a) Length of WP = $48 \div 4 = 12$ cm</p> <p>(b) The total length of the two sides of the isosceles triangle is longer than its third side, WP $= 112 \div 8 = 14$ cm \therefore Perimeter of the isosceles triangle = $14 + 2 \times 12 = 38$ cm</p>
Q17	<p>Amount collected from files = $(1176 + 147) \div 2 = 661.50$ Amount collected from pen = $(1176 - 147) \div 2 = 514.50$</p> <p>3 blocks of files \rightarrow \$661.50 1 block of files \rightarrow $\\$661.50 \div 3 = \\220.50 1 block of pens \rightarrow \$514.50</p> <p>Since each pen was sold for \$3 more than a file, 1 block of pens sold = $(514.50 - 220.50) \div 3$ $= 294 \div 3$ $= 98$</p>

www.sgexam.com