

Name: _____ ()

Class: Primary 6 _____

CHIJ ST NICHOLAS GIRLS' SCHOOL (PRIMARY)

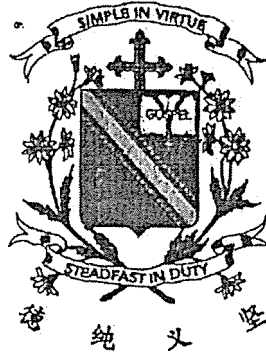

Primary 6 Mathematics

2025 Weighted Assessment

Term 1 Week 9

Total Marks	30
-------------	----

Parent's/Guardian's Signature

Time : 50 minutes

INSTRUCTIONS TO CANDIDATES

Do not turn over this page until you are told to do so.

Follow all instructions carefully.

Answer all questions.

Write your answers in this booklet.

The use of an approved calculator is expected, where appropriate.

This booklet consists of 9 printed pages.

Questions 1 to 3 carry 2 marks each. Show your working clearly and write your answers in the spaces provided. For questions which require units, give your answers in the units stated. (6 marks)

Do not write in this space

1. Vani baked 720 cookies. She packed 18 cookies into each of the 25 bags. What fraction of the cookies baked were packed into the 25 bags? Leave your answer in the simplest form

Ans : _____

2. Two groups of pupils, X and Y, visited a museum. There was an equal number of pupils in both groups. 35 pupils from Group X joined Group Y. In the end, there were 121 pupils in Group Y. How many pupils visited the museum altogether?

Ans : _____



3. In the figure below, ABCD is a parallelogram. DGC and HGC are triangles. Given that CE and DF are straight lines, find $\angle GHC$.

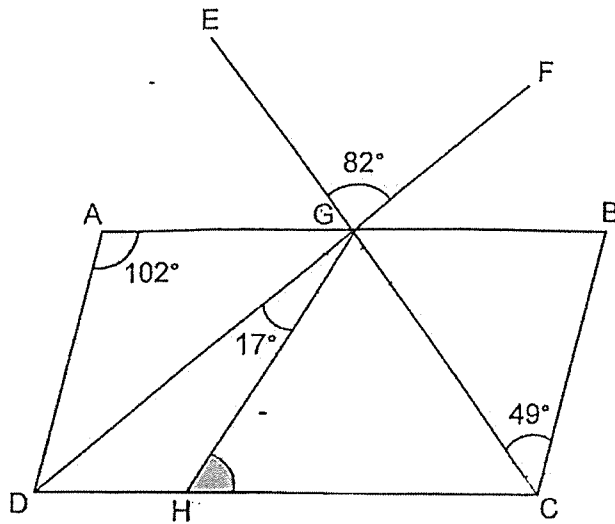

Ans : _____ °



For questions 4 to 9, show your working clearly and write your answers in the spaces provided. The number of marks available is shown in the brackets () at the end of each question or part-question. (24 marks)

Do not write in this space

4. The bar graph below shows the types of pies sold in a bakery in a day.

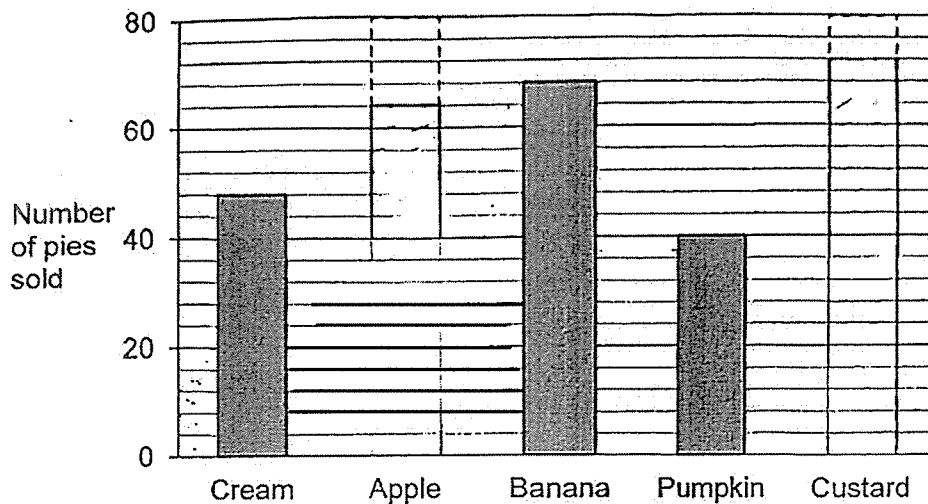

- (a) How many banana pies were sold?

Ans : _____ [1]

- (b) The ratio of the number of cream pies sold to the number of apple pies sold was 3 : 4. There were 8 more custard pies sold than apple pies sold. How many apple pies and custard pies were sold?

Complete the bar graph.

[2]



5. Martha had 2 pieces of wire. Each of them measured 40 cm. She bent one wire into a square and the other wire into a rectangle with a length of 17 cm. There was no wire left.

Do not write in this space

(a) What was the area of the square?

Ans : (a) _____ [1]

(b) What was the breadth of the rectangle?

Ans : (b) _____ [1]

(c) Find the ratio of the total area of the square and the rectangle to the area of the rectangle.

Ans : (c) _____ [1]



6. ACD is an equilateral triangle and $AC = BC$. BD is a straight line.

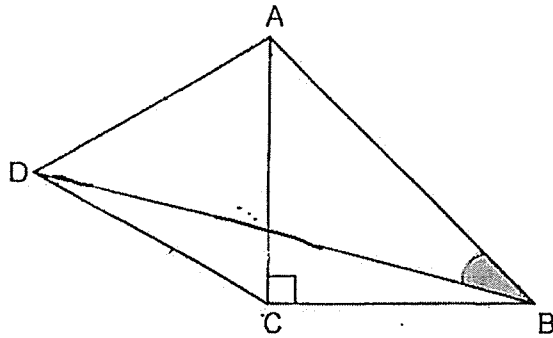

- (a) Find $\angle ABD$.

Ans : (a) _____ [3]

- (b) Find $\angle AED$.

Ans : (b) _____ [1]

Do not
write in
this
space



7. At a camp, $\frac{6}{11}$ of the pupils are girls. $\frac{3}{4}$ of the girls do not wear spectacles and 48 boys wear spectacles. Altogether there are 90 pupils who wear spectacles.

Do not
write in
this
space

(a) What is the total number of boys at the camp?

Ans : (a) _____ [3]

(b) How many boys do not wear spectacles?

Ans : (b) _____ [1]



8. Two rectangular tanks, A and B, are shown below.

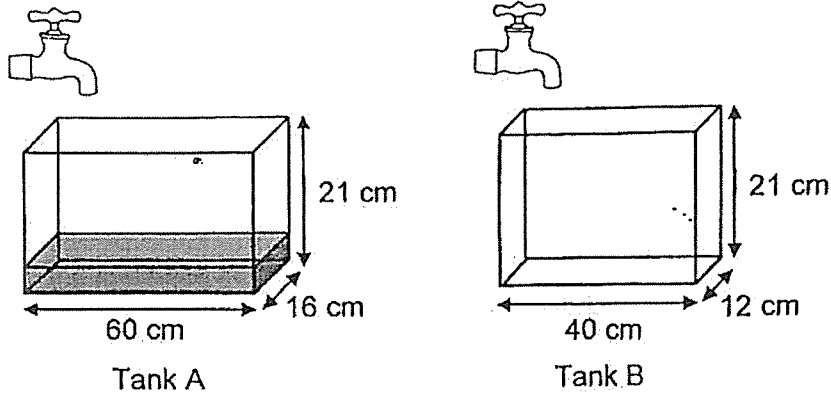

At first, $\frac{1}{7}$ of Tank A was filled with water and Tank B was empty.

- (a) What was the volume of water in Tank A at first?

Ans : (a) _____ [2]

- (b) Both taps were turned on at the same time. Water from both taps flowed at the same rate. After Tank B was fully filled with water, Tank A took another 7.5 min to be filled to the brim. How much water flowed into Tank A in 1 minute?

Ans : (b) _____ [3]

Do not
write in
this
space

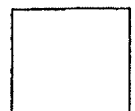

9. At a shop, rolls of ribbon were sold at \$7 each. For every 3 rolls of ribbon bought, customers were given one roll free.

(a) Last Friday, some customers bought either 1 roll or 3 rolls of ribbon.

The shopkeeper collected a total amount of \$1925 from the sale of ribbons and gave away 65 rolls free. How many customers bought only one roll of ribbon?

Do not
write in
this
space

Ans : (a) _____ [3]

(b) Lenice used pieces of ribbons, each of length 110 cm, to tie 25 parcels.

Ribbon was sold in rolls of 300 cm each. What was the least amount of money that Lenice paid for the rolls of ribbon?

Ans : (b) _____ [2]

THE END

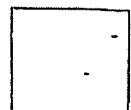

www.sgexam.com

SCHOOL : CHIJ ST NICHOLAS GIRLS' SCHOOL
LEVEL : PRIMARY 6
SUBJECT : MATHEMATICS
TERM : 2025 WEIGHTED ASSESSMENT 1

Q1	$18 \times 25 = 450$ $\frac{450}{720} = \frac{5}{8}$
Q2	$121 - 35 = 86$ $86 \times 2 = 172$
Q3	$\angle BAD = \angle BCH = 102^\circ$ $\angle GCH = 102^\circ - 49^\circ = 53^\circ$ $\angle EGF = \angle DGC = 82^\circ$ $\angle HGC = 82^\circ - 17^\circ = 65^\circ$ $\angle GHC = 180^\circ - 53^\circ - 65^\circ = 62^\circ$
Q4	(a) $20 \div 5 = 4$ $60 + 4 + 4 = 68$ (b) $48 \div 3 = 16$ $16 \times 4 = 64$ $64 + 8 = 72$
Q5	(a) $40 \div 4 = 10$ $10 \times 10 = 100 \text{ cm}^2$ (b) $17 \times 2 = 34$ $40 - 34 = 6$ $6 \div 2 = 3$ (c) $3 \times 17 = 51$ $51 + 100 = 151$ Ans: 151:51
Q6	(a) $90^\circ + 60^\circ = 150^\circ$ $\angle BDC = \angle DBC = (180^\circ - 150^\circ) \div 2 = 15^\circ$ $\angle CAB = \angle CBA = (180^\circ - 90^\circ) \div 2 = 45^\circ$ $\angle ABD = 45^\circ - 15^\circ = 30^\circ$ (b) $\angle ADE = 60^\circ - 15^\circ = 45^\circ$ $\angle AED = 180^\circ - 60^\circ - 45^\circ = 75^\circ$
Q7	(a) 140 (b) $140 - 48 = 92$

Q8	<p>(a) $60 \times 16 \times 21 = 20160$ $20160 \times \frac{1}{7} = 2880$ ml</p> <p>(b) $40 \times 12 \times 21 = 10080$ $20160 - 2880 = 17280$ $17280 - 10080 = 7200$ 7.5 min \rightarrow 7200 1 min $\rightarrow 7200 \div 7.5 = 960$ ml</p>
Q9	<p>(a) $65 \times 3 = 195$ $195 \times 7 = 1365$ $1925 - 1365 = 560$ $560 \div 7 = 80$</p> <p>(b) \$70</p>

www.sgexam.com