



Rosyth School
Term Assessment 2025 (Term 2)
Mathematics
Primary 6
Paper 1

Name: _____ Register No. _____

Class: Pr 6 - _____

Date: 8 May 2025 Parent's Signature: _____

Total Time for Booklets A and B : 1 hour

BOOKLET A

Instructions to Pupils:

1. Do not open this booklet until you are told to do so.
2. Follow all instructions carefully.
3. Answer all questions.
4. Use a 2B pencil to shade your answers in the Optical Answer Sheet (OAS).
5. The use of calculators is **NOT** allowed.

Section	Maximum Mark	Marks Obtained
Paper 1 (Booklet A)	20	

* This booklet consists of 7 pages (including this cover page).

*This is a non-weighted assessment. The purpose of this term assessment is to monitor learning and to provide feedback.

Questions 1 to 10 carry 1 mark each. Questions 11 to 15 carry 2 marks each. For each question, four options are given. One of them is the correct answer. Make your choice (1, 2, 3 or 4). Shade the oval (1, 2, 3 or 4) on the Optical Answer Sheet.

All diagrams in this paper are not drawn to scale unless stated otherwise.
(20 marks)

1. What does the digit 7 in 2 879 053 stand for?

- (1) 700
- (2) 7000
- (3) 70 000
- (4) 700 000

2. What one of the following has the same value as $5 \div \frac{3}{4}$?

- (1) $12 \div 5$
- (2) $15 \div 4$
- (3) $20 \div 3$
- (4) $20 \div 4$

3. In the figure below, which of the following pairs of lines are parallel?

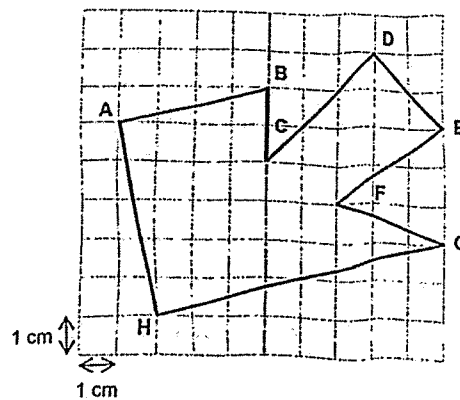

- (1) AH and BC
- (2) CD and FE
- (3) AB and FE
- (4) AB and HG

4. Jane, Kelly and Mike shared some bookmarks. Kelly's share was half of the total number of bookmarks. Mike's share was $\frac{5}{12}$ of the total number of bookmarks. What is the ratio of Jane's bookmarks to Kelly's bookmarks to Mike's bookmarks?
- (1) 1 : 5 : 6
(2) 1 : 6 : 5
(3) 5 : 6 : 1
(4) 6 : 5 : 1
5. The average mass of 4 durians was 2 kg. A fifth durian had a mass of 1.8 kg. What is the total mass of the 5 durians?
- (1) 3.8 kg
(2) 8 kg
(3) 9.8 kg
(4) 10 kg
6. The table below shows the number of puzzles Ken completed in the morning and afternoon last week. On how many days was he able to complete at least 3 puzzles?

Day	Number of Puzzles Completed	
	Morning	Afternoon
Monday	2	1
Tuesday	3	2
Wednesday	1	1
Thursday	0	3
Friday	3	1

- (1) 5
(2) 2
(3) 3
(4) 4

7. A pen cost 80 cents. Siling bought w similar pens. She gave the cashier some money and received \$2 as change. How much did she give to the cashier?

- (1) $\$(2 + 0.08w)$
- (2) $\$(2 + 0.8w)$
- (3) $\$(2 + 8w)$
- (4) $\$(2 + 80w)$

8. In the figure below, not drawn to scale, ABEF is a trapezium and FED is a straight line. Find $\angle CED$.

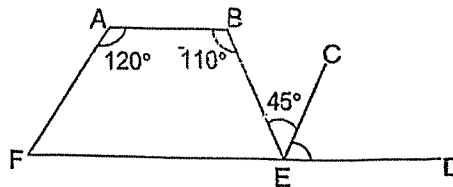

- (1) 25°
- (2) 45°
- (3) 65°
- (4) 75°

9. The figure below is made up of 2 quarter circles and a square. Find its area.

(Take $\pi = \frac{22}{7}$)

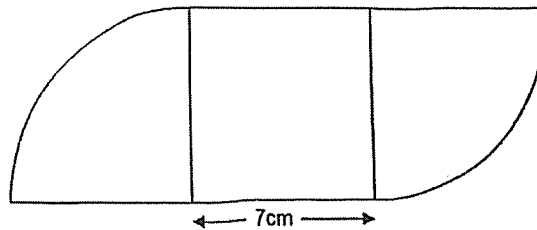

- (1) 77 cm^2
- (2) 126 cm^2
- (3) 154 cm^2
- (4) 203 cm^2

10. Arrange these fractions from the largest to the smallest.

$$\frac{5}{8}, \quad \frac{1}{5}, \quad \frac{5}{7}$$

- | | <u>Largest</u> | | <u>Smallest</u> |
|-----|-----------------|-----------------|-----------------|
| (1) | $\frac{5}{7}$, | $\frac{5}{8}$, | $\frac{1}{5}$ |
| (2) | $\frac{5}{8}$, | $\frac{1}{5}$, | $\frac{5}{7}$ |
| (3) | $\frac{1}{5}$, | $\frac{5}{7}$, | $\frac{5}{8}$ |
| (4) | $\frac{5}{7}$, | $\frac{1}{5}$, | $\frac{5}{8}$ |

11. In the diagram below, ABC and EDC are straight lines. AE is parallel to BD. Find $\angle ACE$.

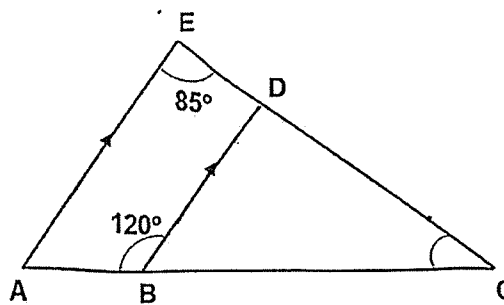

- (1) 35°
- (2) 45°
- (3) 60°
- (4) 85°

12. The table shows the rate of charges for each overdue book borrowed from a library.

For the first 7 days	50 cents per day
After 7 days	80 cents per day

Weiming borrowed a book from the library. The book was overdue when he returned it. He paid the librarian \$10 for the overdue book and received some change back. What was the maximum number of days that his book could be overdue?

- (1) 12 days
(2) 14 days
(3) 15 days
(4) 16 days
13. The mass of a box with 50 identical rubber balls is 1500 g. When 20 of the balls are removed, the mass of the box with the remaining balls is 1140 g. What is the mass of each rubber ball?
- (1) 12 g
(2) 18 g
(3) 30 g
(4) 38 g
14. Water flows out of a hose at a rate of 1 litre per minute. How long will it take to fill a container 25 cm long, 30 cm wide and 10 cm high to $\frac{2}{5}$ of its capacity?
- (1) 5 minutes
(2) 2 minutes
(3) 3 minutes
(4) 10 minutes

15. Jack spent $\frac{1}{4}$ of his money on a new bicycle, $\frac{3}{8}$ of it on a camera and $\frac{1}{3}$ of the remainder on a bag and a watch. The cost of the watch was \$110 and the bag cost \$80 more than the watch. How much was the bicycle?

- (1) \$600
- (2) \$800
- (3) \$1600
- (4) \$2400



Rosyth School
Term Assessment 2025 (Term 2)
Mathematics
Primary 6
Paper 1

Name: _____

Register No. _____

Class: Pr 6 - _____

Date: 8 May 2025

Parent's Signature: _____

Total Time for Booklets A and B : 1 hour

BOOKLET B

Instructions to Pupils:

1. Do not turn over this page until you are told to do so.
2. Follow all instructions carefully.
3. Answer all questions.
4. Use a dark blue or black ballpoint pen to write your answers in the space provided for each question.
5. The use of calculators is **NOT** allowed.
6. Do not use correction fluid/tap.
7. Do not use highlighters on any part of your answers.

Section	Maximum Mark	Marks Obtained
Paper 1 (Booklet B)	25	

* This booklet consists of 10 pages (including this cover page).

*This is a non-weighted assessment. The purpose of this term assessment is to monitor learning and to provide feedback.

Questions 16 to 20 carry 1 mark each. Write your answers in the spaces provided. For questions which require units, give your answers in the units stated.

Do not
write in this

All diagrams in this paper are not drawn to scale unless stated otherwise.

(5 marks)

16. Find the value of $5.03 \div 10$.

Ans: _____

17. How many lines of symmetry does the following figure have?

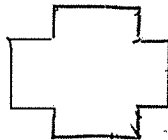

Ans: _____

18. Find the value of $1 - \frac{1}{5} - \frac{1}{3}$.
Express your answer as a fraction in its simplest form.

Ans: _____

19. In July, Mrs Tan sold 1000 muffins. This was 200 more muffins than what she sold in June. What was the percentage increase on the muffins sold in July?

Do not write in this space

Ans: _____ %

20. The square grid shows the positions of points P, Q, R, S, T and U.

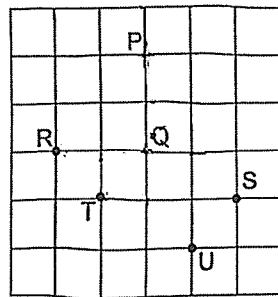

Siva was at one of the points facing T. After he turned 135° clockwise, he faced point P. Which point was Siva at?

Ans: _____

Questions 21 to 30 carry 2 marks each. Show your workings clearly in the space provided for each question and write your answers in the spaces provided. For questions which require units, give your answers in the units stated.

Do not
in this

All diagrams in this paper are not drawn to scale unless stated otherwise.

(20 marks)

21. In the figure below, three identical circles are enclosed in a rectangle. Points A, B and C are centers of the 3 circles. What is the length of the rectangle?

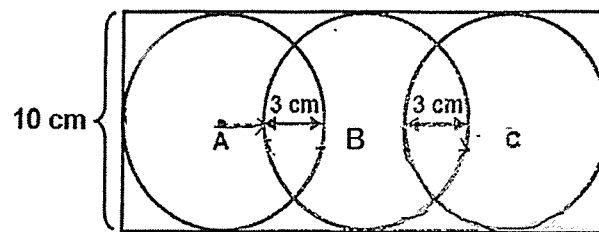

Ans: _____ cm



22. The line graph below shows the amount of money Jenny saved from January 2024 to June 2024. She was given a monthly allowance of \$200.

Do not write
in this space

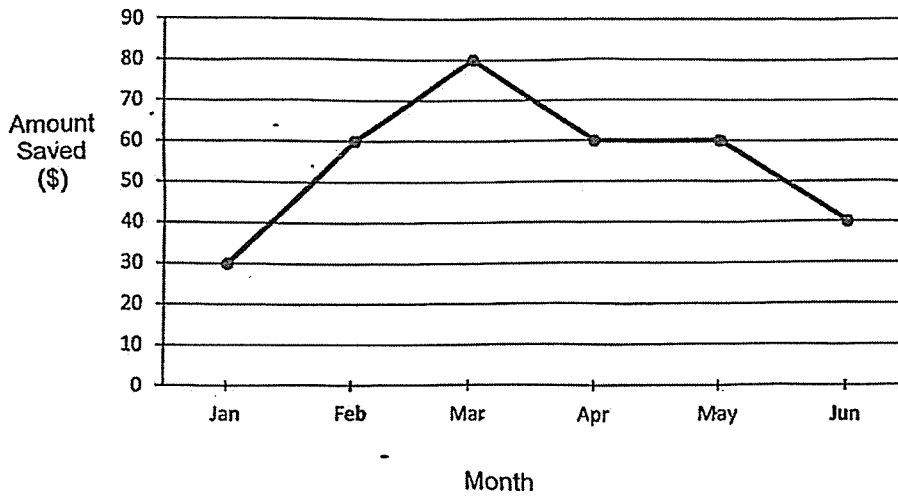

(a) How much did she spend from March to May?

Ans: \$ _____

(b) What was the percentage increase in her saving from January to March? Round off your answer to the nearest 2 decimal places.

Ans: _____ %

23. In the figure below, AGED is a parallelogram. ACD and DFE are triangles. Given that $\angle FGB = 70^\circ$, $\angle ACD = 30^\circ$ and $\angle BDA = 30^\circ$, find $\angle HDB$.

Do I
in th

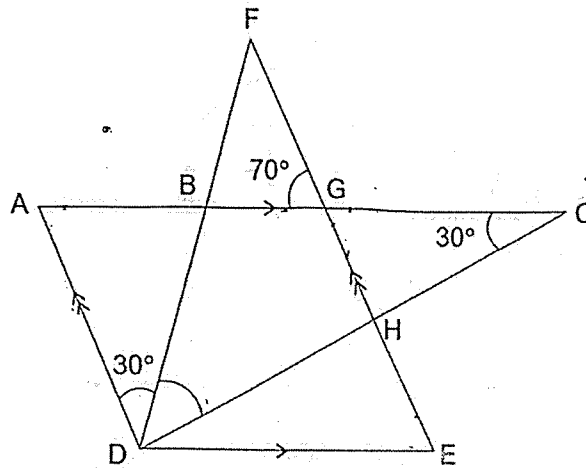

Ans: _____ °



24. In the figure below, ABCD is a square and ABE is an equilateral triangle. Find the value of $\angle BED$.

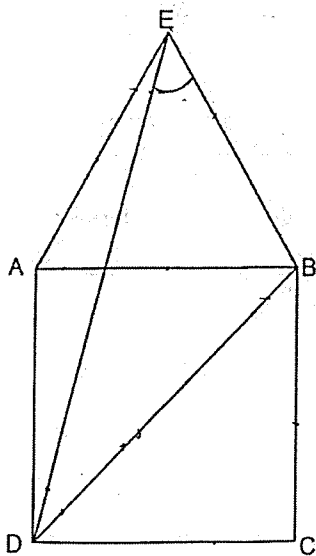

Ans: _____ °



25. Millie and Lisa shared some stickers in the ratio 1 : 3. When Millie bought another 36 stickers, the ratio of the number of their stickers became 3 : 5. How many stickers did Lisa have?

Do not write
in this space

Ans: _____

26. A rectangular tank with height 10 cm was half-filled with 1.5 litres of water. The ratio of the length to the breadth of the tank is 4 : 3.

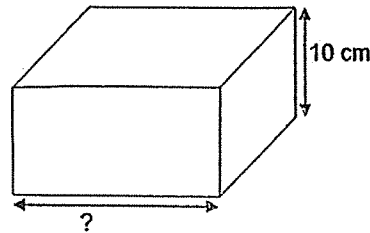

- (a) What is the length of the tank?

Ans: _____ cm

- (b) All the water was then poured into smaller bottles without spilling. Each bottle is filled with 300 ml of water. How many of such bottles were filled?

Ans: _____

27. Danny could either buy 25 pens or 10 files with his money. He decided to spend all his money on both pens and files. Given that he bought 8 files, how many pens did he buy?

Do not write in this space

Ans: _____

28. A school stage is decorated with a banner made up of 335 red and white triangles. One end of the banner is shown below. There are 4 red triangles between every 3 white triangles. How many red triangles are there on the banner?

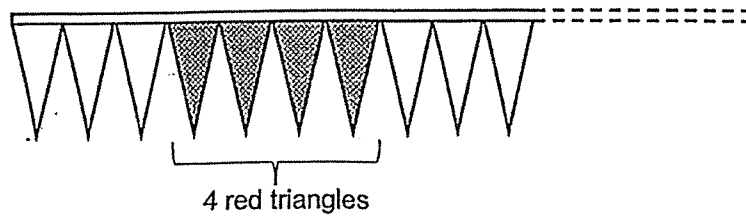

Ans: _____

29. Siti bought some hairclips and ribbons at the prices as shown below.

	Price per item
Hairclip	\$4
Ribbon	\$2

$\frac{1}{4}$ of the items she bought were hairclips. The total amount of money spent on all the items was \$60. How many hairclips and ribbons did she buy altogether?

Do not write
in this space

Ans: _____

30. The bar graph below shows the number of cupboards sold over a period of 5 months.

Do not write in this space

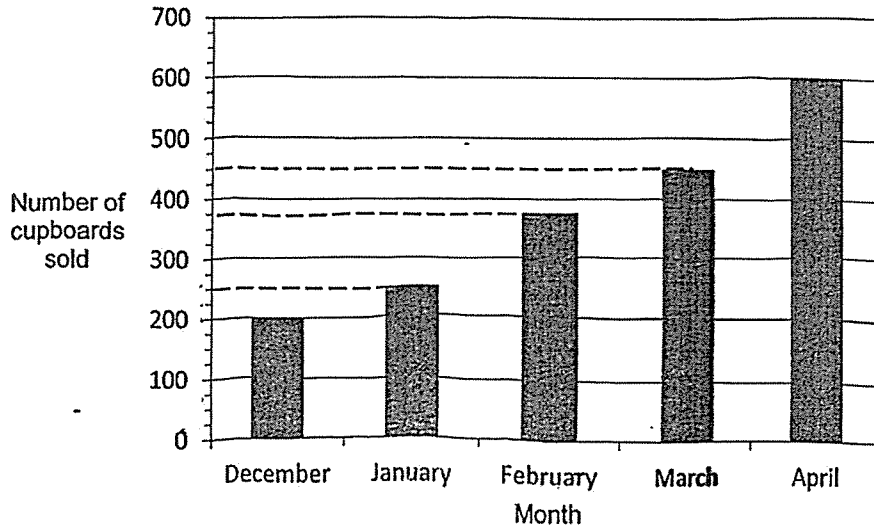

Each of the statement is either true, false or not possible to tell from the information given. For each statement, put a tick (✓) to indicate your answer.

Statement	True	False	Not possible to tell
(a) Between January and February, there was a 50% increase in the sales.			
(b) The increase in the number of cupboards sold from December to January was more than the increase from March to April.			



End of paper
Have you checked your work?



Rosyth School
Term Assessment 2025 (Term 2)
Mathematics
Primary 6
Paper 2

Name: _____

Register No. _____

Class: Pr 6 -

Date: 8 May 2025

Parent's Signature: _____

Time: 1 h 30 min

Instructions to Pupils:

1. Do not turn over this page until you are told to do so.
2. Follow all instructions carefully.
3. Answer all questions.
4. Use a dark blue or black ballpoint pen to write your answers in the space provided for each question.
5. The use of an approved calculator is allowed.
6. Do not use correction fluid/tap.
7. Do not use highlighters on any part of your answers.

Questions	Maximum Mark	Marks Obtained
Q 1 to 5	10	
Q 6 to 17	45	

Section	Maximum Mark	Marks Obtained
Paper 1	45	
Paper 2	55	
Total	100	

* This booklet consists of **18** pages (including this cover page)

*This is a non-weighted assessment. The purpose of this term assessment is to monitor learning and to provide feedback.

Questions 1 to 5 carry 2 marks each. Show your working clearly in the spaces provided for each question and write your answers in the spaces provided. For questions which require units, give your answers in the units stated.

(10 marks)

All diagrams in this paper are not drawn to scale unless stated otherwise.

-
1. The volume of a cube is 5.832 litres. Find the length of one side of the cube.

Ans: _____ cm

-
2. Mr Shah bought some beads for Jonah and Karish. For every 8 beads Jonah took, Karish took 5. In the end, Jonah had 216 more beads than Karish. How many beads did Mr Shah buy?

Ans: _____

3. The table shows the parking charges at a car park.

Do not write
in this space

PARKING CHARGES	
For the first hour	\$3
For every additional $\frac{1}{2}$ hour or part thereof	\$1.25

Mr Teo parked his car from 1 p.m. to 5.39 p.m.
How much parking charges did he have to pay?

Ans: \$ _____

4. The line graph shows the number of books borrowed from a library from Monday to Friday.

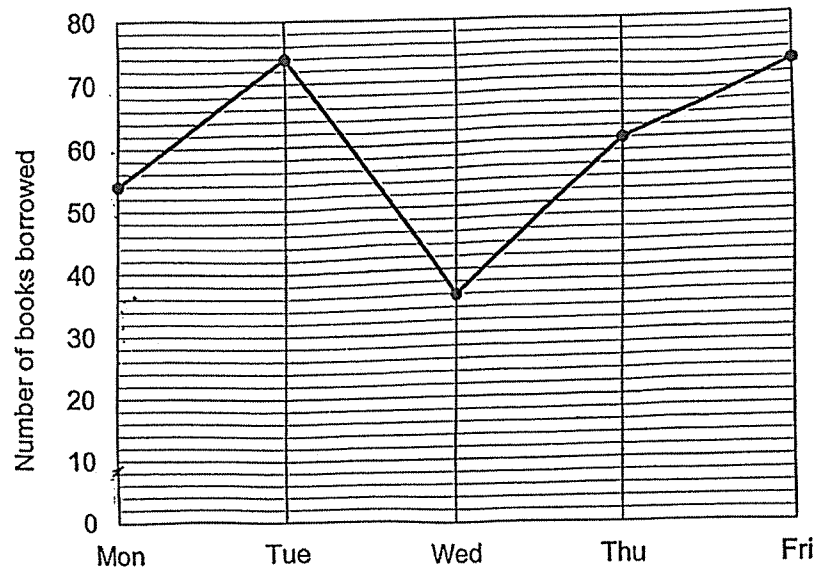

Which were the two days when the ratio of the number of books borrowed were 3 : 4?

Answer : _____ and _____ [2]

- 5 Company A and Company B sent their recyclable waste for recycling in the quantities shown in the table below.

	Plastic (kg)	Paper (kg)	Glass (kg)
Company A	90	75	56
Company B	100	50	84

Both companies were paid for their recyclable waste according to the charges as shown in the table below.

Recyclable	Price per kg
Plastic	\$0.30
Paper	\$0.80
Glass	\$1.00

- (a) Which Company, A or B, received more money for their recycling efforts?

Ans: (a) Company _____ [1]

- (b) How much more?

Ans: (b) Amount: \$ _____ [1]

Do not write
in this space



For Questions 6 to 17, show your working clearly in the space provided for each question and write your answers in the spaces provided. The number of marks available is shown in brackets [] at the end of each question or part-question. For questions which require units, give your answers in the units stated.

(45 marks)

All diagrams in this paper are not drawn to scale unless stated otherwise.

6. In the square grid below, AB and CD are straight lines.

(a) Measure and write down the size of $\angle ABC$.

Ans : (a) _____ [1]

(b) AB and BC form two sides of a trapezium ABCD. AD is parallel to BC. AD is twice the length of BC. Complete the drawing of trapezium ABCD.

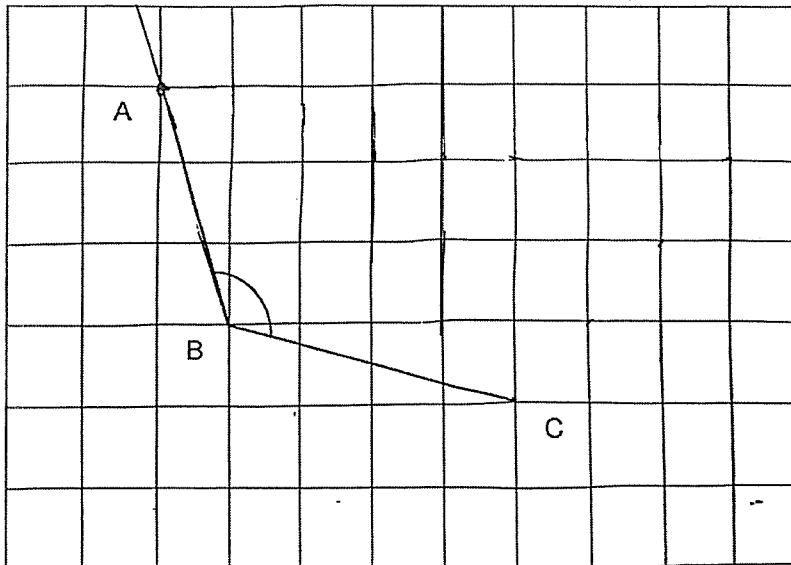

[2]



7. An ice cream shop sold ice cream cones from 16 00 to 20 00 last Friday. The line graph shows the number of ice cream cones sold every hour from 16 00 onwards.

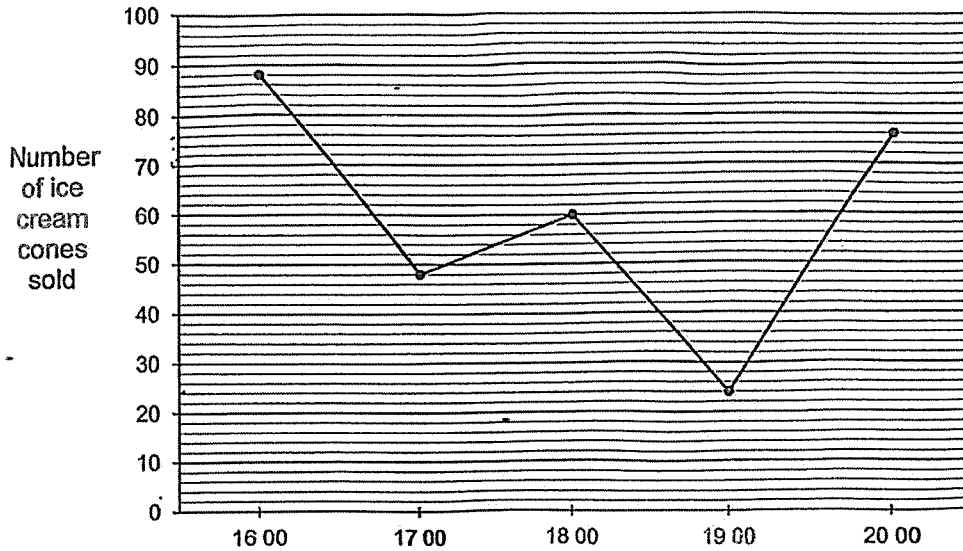

- (a) At what time interval was there the greatest decrease in the number of ice cream cones sold?

Ans: (a) _____ to _____ [1]

- (b) What percentage of the total ice cream cones was sold at 18 00?
Round your answer to 2 decimal places.

(b) _____ [2]

Do not write
in this space

8. Jazel is 45 years older than Zane. The ratio of Jazel's age to Zane's age now is 6 : 1. In how many years' time will the ratio of Jazel's age to Zane's age be 4 : 1?

Ans: _____ [3]

9. Joan had 19 more blue marbles than red marbles. After giving away 37 blue marbles and 42 red marbles, the number of red marbles left was $\frac{3}{5}$ the number of blue marbles left.

Do not write
in this space

(a) How many more blue marbles than red marbles were there left?

Ans: (a) _____ [1]

(b) How many red marbles did Joan have at first?

Ans: (b) _____ [2]

10. The average height of a group of children was 154.8 cm. When Mrs Lim measured and recorded the height of these children, she wrongly recorded one child's height as 182 cm when it should have been 128 cm. As a result, Mrs Lim calculated the average height as 157.8 cm. How many children were there in the group?

Ans: _____ [3]

11. In the figure shown below, PQRS is a trapezium. $PS \parallel VR$ and $VR = QR$. PST is a straight line.

Do not write
in this space

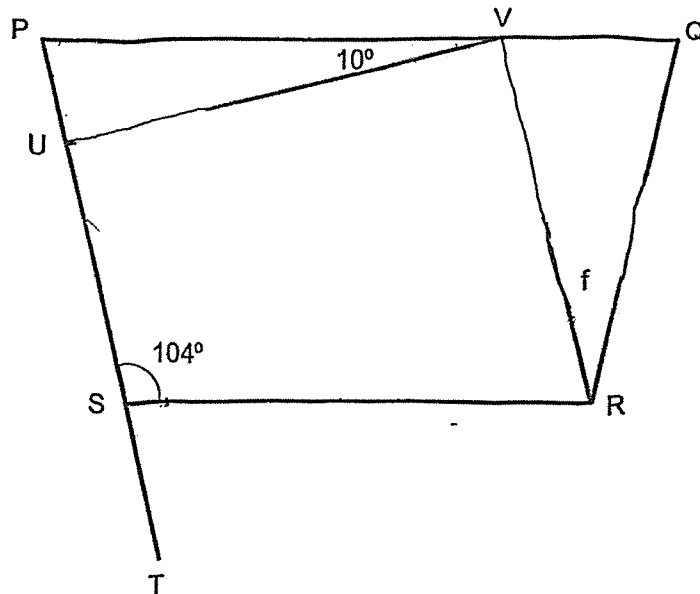

- (a) Find $\angle e$.

Ans: (a) _____ [2]

- (b) Find $\angle f$.

Ans: (b) _____ [2]



12. Mrs Tan had a sum of money. She spent some of it on 3 identical skirts and $\frac{1}{4}$ of the remaining money on 5 identical T-shirts. After that, she was left with $\frac{1}{3}$ of her money. One skirt cost \$55 more than one T-shirt.

(a) What fraction of her money did she spend on the 3 skirts?

Ans: (a) _____ [1]

(b) How much money did she have at first?

Ans: (b) _____ [3]

13. Tank X was $\frac{4}{5}$ -filled with water. Tank Y was empty. The water from Tank X was poured into Tank Y. After that, Tank Y needed another 1944 cm^3 of water to fill to its brim.

Do not write in this space

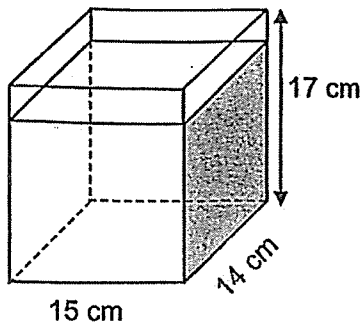

Tank X

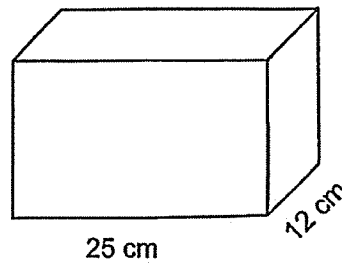

Tank Y

- (a) What was the volume of water in Tank X at first?

Ans: (a) _____ [2]

- (b) What was the height of Tank Y?

Ans: (b) _____ [2]

14. Jie Yi had a square piece of paper. She made 2 folds from the corner to the diagonal line as shown below.

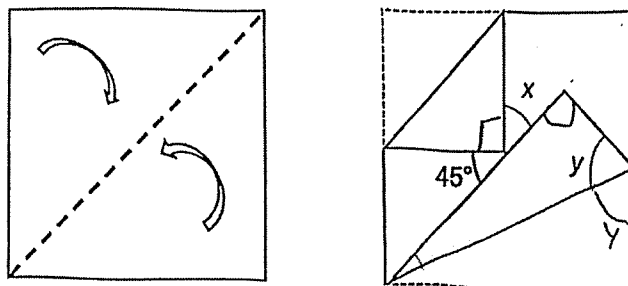

(a) Find $\angle x$.

Ans: (a) _____ [2]

(b) Find $\angle y$.

Ans: (b) _____ [2]

15. The price of a bag in shop A was 75% of the price which shop B sold it for. The bag cost \$900 in shop B. During a sale, both shops offer an equal percentage discount on the bag. The discounted price of the bag before GST in shop B is \$184.50 more than the discounted price of the bag in shop A before GST. What is the percentage discount?

Do not write
in this space

Ans: _____ [8]

16. The first four figures are shown below.

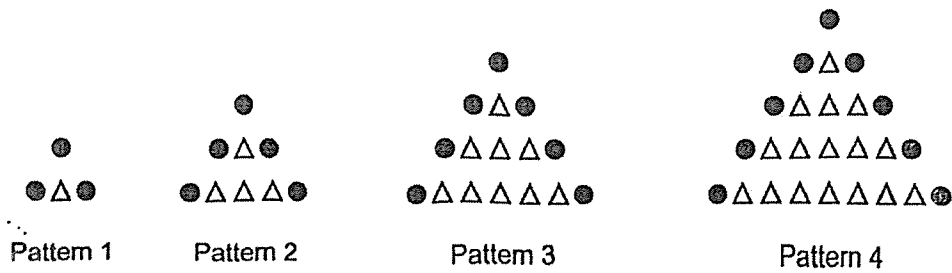

(a) The table below shows the number of circles and triangles used for each figure. Complete the table for Figure 8.

Figure Number	Number of circles	Number of triangles	Total number of circles and triangles
1	3	1	4
2	5	4	9
3	7	9	16
4	9	16	25
.			
.			
.			
8	(a) _____	(a) _____	(a) _____

[1]

(b) How many circles are there Figure 85?

Ans: (b) _____ [2]



C A figure in the pattern has a total of 5184 circles and triangles. How many more triangles than circles does the figure have?

Do not write
in this space

Ans: (c) _____ [2]

17. The figure below is drawn on a square piece of paper as shown below. The length is 12 cm. The figure consists of a rectangle, a large semicircle and 2 identical smaller semicircles. (Take $\pi = 3.14$)

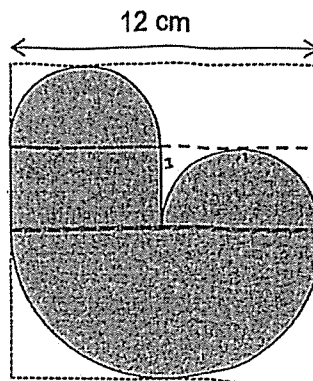

- (a) What is the perimeter of the figure?

Ans: (a) _____ [2]

- (b) What is its area?

Ans: (b) _____ [3]

End of paper
Have you checked your work?

SCHOOL : ROSYTH SCHOOL

LEVEL : PRIMARY 6

SUBJECT : MATH

TERM : 2025 WA2

BOOKLET A

Q1	Q2	Q3	Q4	Q5	Q6	Q7	Q8	Q9	Q10
3	3	4	2	3	4	2	3	2	1
Q11	Q12	Q13	Q14	Q15					
1	3	2	3	1					

BOOKLET B

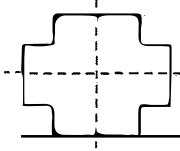
Q16	$5.03 \div 10 = 0.503.$	ANS : 0.503
Q17		ANS : 2
Q18	$1 - \frac{1}{5} - \frac{1}{3} = \frac{15-3-5}{15} = \frac{7}{15}.$	ANS : $\frac{7}{15}$
Q19	$1000 - 200 = 800, 200 \div 800 \times 100\% = 25\%.$	ANS : 25%
Q20	Siva was at point Q.	ANS : Point Q
Q21	$10 - 3 = 7, 7 + 10 + 7 = 24 \text{ cm}.$	ANS : 24 cm
Q22	(a) $200 - 80 = 120, 200 - 60 = 140, 120 + 140 + 140 = 400.$ (b) $80 - 30 = 50, 50 \div 30 \times 100\% = 166\frac{2}{3}\%.$	ANS : (a) \$400 (b) $166\frac{2}{3}\%$
Q23	$\angle DAC = \angle EGC = \angle FGB = 70^\circ,$ $\angle HDB = 180^\circ - 70^\circ - 30^\circ - 30^\circ = 50^\circ.$	ANS : 50°

PAPER 2

Q1	$5.832 \text{ l} = 5832 \text{ cm}^3$, $\sqrt[3]{5832} = 18 \text{ cm}$. <p style="text-align: right;">ANS : 18 cm</p>
Q2	$8 - 5 = 3$, $216 \div 3 = 72$, $72 \times (8 + 5) = 72 \times 13 = 936$. <p style="text-align: right;">ANS : 936</p>
Q3	$\$3 + 4 \times 2 \times \$1.25 = \$3 + \$10 = \$13$ <p style="text-align: right;">ANS : \$13</p>
Q4	$54 : 72 = 3 : 4 \rightarrow$ Monday and Friday. <p style="text-align: right;">ANS : Monday and Friday</p>
Q5	Company received = $\$0.30 \times 90 + \$0.80 \times 75 + \$1 \times 56 = \143 , Company received = $\$0.30 \times 100 + \$0.80 \times 50 + \$1 \times 84 = \154 . (a) Company B received more money than Company A. (b) $\$154 - \$143 = \$11$. <p style="text-align: right;">ANS : Company B \$11</p>
Q6	(a) $\angle ABC = 122^\circ$. (b) <p style="text-align: right;">ANS : (a) 122° (b) See figure</p>
Q7	(a) $1600 - 1700$, the decrease = $88 - 48 = 40$, $1800 - 1900$, the decrease = $60 - 24 = 36$. $1600 - 1700$ is the time interval of greatest decrease. (b) Total ice cream cones sold = $88 + 48 + 60 + 24 + 76 = 296$, Percentage of ice cream cones sold at 1800 = $60 \div 296 \times 100\% = 20.27\%$. <p style="text-align: right;">ANS : (a) $1600 - 1700$ (b) 20.27%</p>

Q8	<table style="margin-left: auto; margin-right: auto;"> <thead> <tr> <th></th> <th style="text-decoration: underline;">Jazel</th> <th style="text-decoration: underline;">Zane</th> <th style="text-decoration: underline;">Diff</th> <th></th> <th style="text-decoration: underline;">Jazel</th> <th style="text-decoration: underline;">Zane</th> <th style="text-decoration: underline;">Diff</th> </tr> </thead> <tbody> <tr> <td>Now</td> <td>6</td> <td>1</td> <td>5</td> <td rowspan="2" style="font-size: 2em; vertical-align: middle;">→</td> <td>54</td> <td>9</td> <td>45</td> </tr> <tr> <td>After</td> <td>4</td> <td>1</td> <td>3</td> <td>60</td> <td>15</td> <td>45</td> </tr> </tbody> </table> <p>∴ $60 - 54 = 15 - 9 = 6$ years later.</p> <p>ANS: 6 years' time</p>		Jazel	Zane	Diff		Jazel	Zane	Diff	Now	6	1	5	→	54	9	45	After	4	1	3	60	15	45
	Jazel	Zane	Diff		Jazel	Zane	Diff																	
Now	6	1	5	→	54	9	45																	
After	4	1	3		60	15	45																	
Q9	<p>(a) More blue marbles than red marbles left = $19 + 42 - 37 = 24$.</p> <p>(b) At the end, number of red marbles left = $24 \div 2 \times 3 = 36$.</p> <p>∴ Number of red marbles at first = $36 + 42 = 78$.</p> <p>ANS: (a) 24 (b) 78</p>																							
Q10	<p>The total difference = $182 - 128 = 54$ cm.</p> <p>The average difference = $157.8 - 154.8 = 3$ cm.</p> <p>Thus, the number of children = $54 \div 3 = 18$.</p> <p>ANS: 18</p>																							
Q11	<p>(a)</p> <p>$\angle SPV = 180^\circ - 104^\circ = 76^\circ$ (interior \angles, PQ//SR)</p> <p>∴ $\angle e = \angle SUV = 76^\circ + 10^\circ = 86^\circ$ (exterior \angles of Triangle PUV)</p> <p>(b)</p> <p>$\angle RVQ = \angle SPV = 76^\circ$ (corresponding \angles, PS//VR)</p> <p>$\angle RQV = \angle RVQ = 76^\circ$ (isosceles triangle RVQ)</p> <p>∴ $\angle f = \angle VRQ = 180^\circ - 2 \times 76^\circ = 28^\circ$ (\angle sum of a Triangle VRQ)</p> <p>ANS: (a) 86° (b) 28°</p>																							
Q12	<p>(a) $\left(1 - \frac{1}{4}\right) = \frac{3}{4}$ of the remaining money = $\frac{1}{3}$ of her money</p> <p>⇒ Remaining money = $\frac{1}{3} \div \frac{3}{4} = \frac{1}{3} \times \frac{4}{3} = \frac{4}{9}$ of her money.</p> <p>⇒ $1 - \frac{4}{9} = \frac{5}{9}$ of the money was spent on the 3 skirts.</p> <p>(b) $\frac{1}{4}$ of the remaining money = $\frac{1}{3} \div 3 = \frac{1}{3} \times \frac{1}{3} = \frac{1}{9}$ of her money</p> <p>$\frac{1}{9}$ of her money ⇒ 5 T-shirts and therefore,</p> <p>$\frac{5}{9}$ of the money = 25 T-shirts and also, we have</p> <p>$\frac{5}{9}$ of the money ⇒ 3 skirts = $3(\text{T-shirts} + \\$55) = 3 \text{ T-shirts} + \\165,</p> <p>Hence, 22 T-shirts = \$165, 1 T-shirts = $\\$165 \div 22 = \\7.50.</p> <p>She has $9 \times 5 \times \\$7.50 = \\337.50 at first.</p> <p>ANS: (a) $\frac{5}{9}$ (b) \$337.50</p>																							

Q13	<p>(a) Volume of water in Tank X at first $= 15 \times 14 \times 17 \times \frac{4}{5} = 2856 \text{ cm}^3$.</p> <p>(b) Capacity of Tank Y = $2856 + 1944 = 4800 \text{ cm}^3$. Height of Tank Y = $4800 \div 25 \div 12 = 16 \text{ cm}$.</p> <p style="text-align: right;">ANS : (a) 2856 cm^3 (b) 16 cm</p>								
Q14	<p>(a) $\angle x = 180^\circ - 45^\circ - 90^\circ = 45^\circ$. ($\angle$ sum on a straight line) (b) $2 \angle y = 180^\circ - 90^\circ = 135^\circ$, $\therefore \angle y = 135^\circ \div 2 = 67.5^\circ$.</p> <p style="text-align: right;">ANS : (a) 45° (b) 67.5°</p>								
Q15	<p>Cost of bag in shop B = \$900. Cost of bag in shop A = $\\$900 \times 75\% = \\675. The price difference before any discount = $\\$900 - \\$675 = \\$225$. With same percentage discount given by both shops, the price difference is \$184.50. Thus the percentage discount given is. Percentage discount = $(225 - 184.50) \div 225 \times 100\% = 18\%$.</p> <p style="text-align: right;">ANS : 18%</p>								
Q16	<div style="text-align: center;"> <p>Pattern 1 Pattern 2 Pattern 3 Pattern 4</p> </div> <table border="1" style="width: 100%; border-collapse: collapse; margin-top: 10px;"> <thead> <tr> <th style="padding: 5px;">Figure Number</th> <th style="padding: 5px;">Number of circles</th> <th style="padding: 5px;">Number of Triangles</th> <th style="padding: 5px;">Total number of circles and triangles</th> </tr> </thead> <tbody> <tr> <td style="padding: 5px; text-align: center;">8</td> <td style="padding: 5px;">(a) <u>17</u></td> <td style="padding: 5px;">(a) <u>64</u></td> <td style="padding: 5px;">(a) <u>81</u></td> </tr> </tbody> </table> <p>(b) In Figure 85, number of circles = $2(85) + 1 = 171$. (c) The Figure Number = $\sqrt{5184} - 1 = 72 - 1 = 71$. Figure has more triangles than circles $= 71^2 - (2 \times 71 + 1) = 4898$.</p> <p style="text-align: right;">ANS: (a) 17, 64, 81 (b) 171 (c) 4898</p>	Figure Number	Number of circles	Number of Triangles	Total number of circles and triangles	8	(a) <u>17</u>	(a) <u>64</u>	(a) <u>81</u>
Figure Number	Number of circles	Number of Triangles	Total number of circles and triangles						
8	(a) <u>17</u>	(a) <u>64</u>	(a) <u>81</u>						

Q17	<p>Radius of small circles = $12 \div 4 = 3$ cm. Radius of large circle = $12 \div 2 = 6$ cm.</p> <p>(a) Perimeter of the figure $= 2 \times 3.14 \times 3 + 0.5 \times (2 \times 3.14 \times 6) + 3 + 3$ $= 18.84 + 18.84 + 6$ $= 43.68$ cm.</p> <p>(b) Area of the figure $= 3.14 \times 3^2 + 0.5 \times 3.14 \times 6^2 + 6 \times 3$ $= 28.26 + 56.52 + 18$ $= 102.78$ cm².</p> <p>ANS: (a) 43.68 cm (b) 102.78 cm²</p>
-----	---

www.sgexam.com