

Name: _____ ()

Class: Primary 6 _____

CHIJ ST NICHOLAS GIRLS' SCHOOL (PRIMARY)

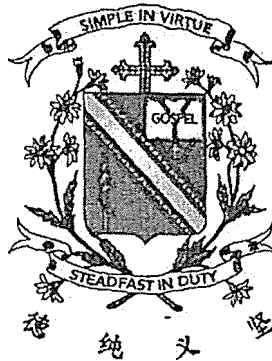

Primary 6 Mathematics

2025 Weighted Assessment

Term 2 Week 9

Total Marks	30
-------------	----

Parent's/Guardian's Signature

Time : 50 minutes

INSTRUCTIONS TO CANDIDATES

Do not turn over this page until you are told to do so.

Follow all instructions carefully.

Answer all questions.

Write your answers in this booklet.

The use of an approved calculator is expected, where appropriate.

This booklet consists of 11 printed pages.

Questions 1 to 3 carry 2 marks each. Show your working clearly and write your answers in the spaces provided. For questions which require units, give your answers in the units stated. (6 marks)

Do not write in this space

1. Aisha had a total number of 252 red and green beads at first. The ratio of the number of red beads to number of green beads was 5 : 7. She gave away 47 red beads. How many red beads did Aisha have left?

Ans : _____

2. Ben spent \$80 on Saturday. He spent \$84 on Sunday. What was the percentage increase in his spending from Saturday to Sunday?

Ans : _____ %



3. The figure is made up of four identical rectangles with a breadth of 5 cm and a square with an area of 225 cm^2 . Find the total area of the 4 rectangles.

Do not write in this space

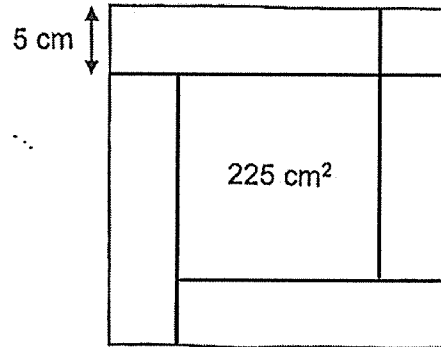

Ans : _____ cm^2



For questions 4 to 9, show your working clearly and write your answers in the spaces provided. The number of marks available is shown in the brackets [] at the end of each question or part-question. (24 marks)

Do not write in this space

4. QSTU is a parallelogram. RQS is an isosceles triangle, $QR = QS$. RQU and PQS are straight lines.

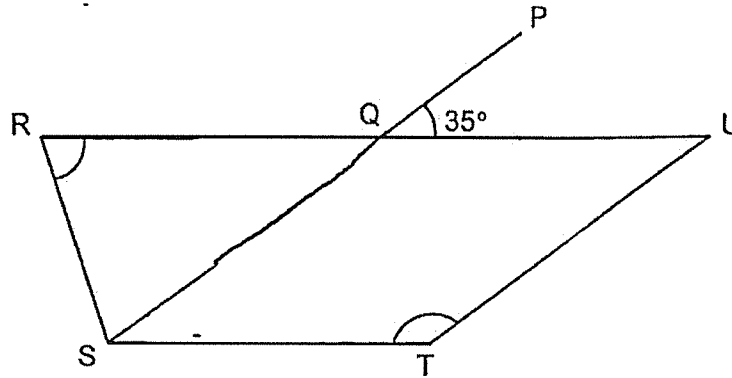

- (a) Find $\angle QRS$.

Ans: (a) _____ [1]

- (b) Find $\angle STU$.

Ans: (b) _____ [1]

- (c) Circle the words that describe RUTS in the statement.

RUTS (is / is not) a trapezium and RU (is / is not) parallel to ST.

[1]

5.

Great Singapore Sale!

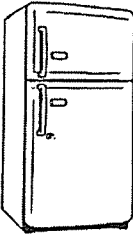

Buy first refrigerator at 20% discount

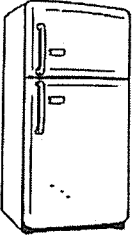

Buy second refrigerator at 40% discount

Do not write in this space

Sue paid \$1120 for two refrigerators during the Great Singapore Sale. How much would she have had to pay for the two refrigerators when there was no sale?

Ans : _____ [3]

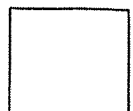

6. The shaded figure is formed by 3 straight lines and 6 identical quarter circles.
Take $\pi = 3.14$.

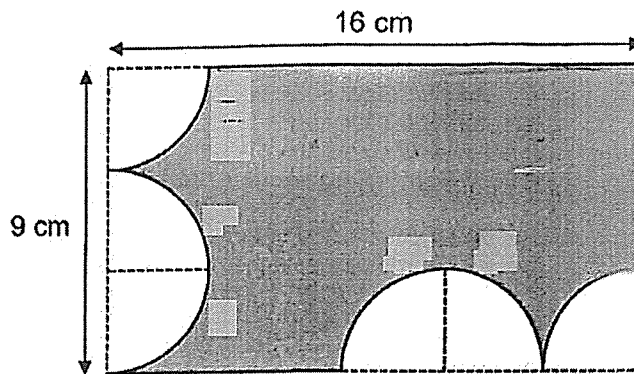

Do not
write in
this
space

- (a) What is the radius of each quarter circle?

Ans: (a) _____ [1]

- (b) Find the area of the shaded figure.

Ans: (b) _____ [2]

(Go on to the next page)



(c) Find the perimeter of the shaded figure.

Do not
write in
this
space

Ans: (c) _____ [1]

7. Mrs Koh had some red pens and 280 blue pens. She sold 50 red pens and 30% of the blue pens. After that, the ratio of the number of red pens to blue pens Mrs Koh had left was 3 : 7.

Do not
write in
this
space

- (a) How many blue pens did Mrs Koh sell?

Ans: (a) _____ [1]

- (b) What fraction of the red pens were sold? Give your answer in the simplest form.

Ans: (b) _____ [3]



8. Black and white tiles are used to form the following figures that follow a pattern as shown below.

Do not write in this space



Figure 1

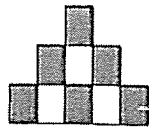

Figure 2

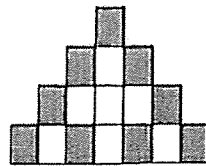

Figure 3

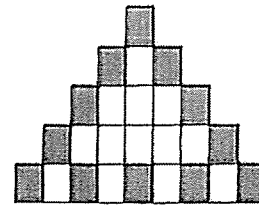

Figure 4

The table shows the number of white tiles and black tiles for the first four figures.

Figure Number	1	2	3	4	5
No. of white tiles	1	3	7	13	
No. of black tiles	3	6	9	12	
Total	4	9	16	25	36

- (a) Complete the table for Figure 5. [1]
- (b) Find the total number of white and black tiles in Figure 10.

Ans : (b) _____ [2]

- (c) Which figure number has 133 white tiles?

Ans : (c) Figure _____ [2]

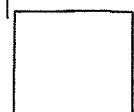

9. At first, Mr Singh had some eggs. He sold $\frac{4}{9}$ of his eggs and gave away 36 eggs. He had $\frac{1}{2}$ of the eggs left and he put them on 30 trays. Some trays had 10 eggs while the rest had 12 eggs.

Do not write in this space

(a) How many eggs were put on the 30 trays?

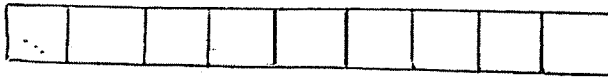

Ans: (a) _____ [1]

(b) How many trays had 10 eggs?

Ans : (b) _____ [2]

(Go on to the next page)

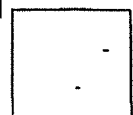

(c)

Special Offer



Buy 12 eggs, get 2 more eggs free.

Do not
write in
this
space

Mrs Toh took home 56 eggs with the special offer. She paid \$2.80 less with the special offer. What was the price of 12 eggs without the special offer?

Ans : (c) _____ [2]

THE END

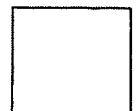

www.sgexam.com

SCHOOL : CHIJ ST NICHOLAS GIRLS' SCHOOL
LEVEL : PRIMARY 6
SUBJECT : MATHEMATICS
TERM : 2025 WEIGHTED ASSESSMENT 2

Q1	$5 + 7 = 12$ $252 \div 12 = 21$ $21 \times 5 = 105$ $105 - 47 = 58$
Q2	$84 - 80 = 4$ $\frac{4}{80} \times 100 = 5$
Q3	$225\text{cm}^2 = 15\text{cm} \times 15\text{cm}$ $15 + 5 = 20$ $20 \times 5 = 100$ $100 \times 4 = 400$
Q4	<p>(a) $\angle PQU = \angle RQS = 35^\circ$ $\angle QRS = \angle QSR = (180^\circ - 35^\circ) \div 2 = 72.5^\circ$</p> <p>(b) $\angle UQS = \angle UTS = 180^\circ - 35^\circ = 145^\circ$</p> <p>(c) RUTS is a trapezium and RU is parallel to ST</p>
Q5	<p>(a) $100\% - 20\% = 80\%$ $100\% - 40\% = 60\%$ $60\% + 80\% = 140\%$ $140\% \rightarrow \\$1120$ $200\% \rightarrow \frac{1120}{140} \times 200$ $= \\$1600$</p>
Q6	<p>(a) $9 \div 3 = 3\text{cm}$ (b) 101.61cm^2 (c) $16 - 3 = 13$ $9 - 3 = 3$ $16 - 3 - 3 - 3 = 7$ $6 \times \frac{1}{4} \times 3.14 \times 2 \times 3 = 28.26$ $28.26 + 13 + 6 + 7 = 54.26 \text{ cm}$</p>

Q7	<p>(a) $280 \times \frac{30}{100} = 84$</p> <p>(b) $280 - 84 = 196$</p> <p>$\frac{196}{7} \times 3 = 84$ (red pens left)</p> <p>$84 + 50 = 134$ (total red)</p> <p>$\frac{50}{134} = \frac{25}{67}$</p>																																										
Q8	<p>(a)</p> <table border="1" data-bbox="359 607 1062 819"> <thead> <tr> <th>Figure Number</th> <th>1</th> <th>2</th> <th>3</th> <th>4</th> <th>5</th> </tr> </thead> <tbody> <tr> <td>No. of white tiles</td> <td>1</td> <td>3</td> <td>7</td> <td>13</td> <td>21</td> </tr> <tr> <td>No. of black tiles</td> <td>3</td> <td>6</td> <td>9</td> <td>12</td> <td>15</td> </tr> <tr> <td>Total</td> <td>4</td> <td>9</td> <td>16</td> <td>25</td> <td>36</td> </tr> </tbody> </table> <p>(b) (Fig no. +1) × (Fig No. +1) = Total No. of tiles</p> <p>$10 + 1 = 11$</p> <p>$11 \times 11 = 121$</p> <p>(c)</p> <table border="1" data-bbox="359 1093 788 1570"> <thead> <tr> <th>Fig No</th> <th>No. of white tiles</th> </tr> </thead> <tbody> <tr> <td>5</td> <td>21</td> </tr> <tr> <td>6</td> <td>31</td> </tr> <tr> <td>7</td> <td>43</td> </tr> <tr> <td>8</td> <td>57</td> </tr> <tr> <td>9</td> <td>73</td> </tr> <tr> <td>10</td> <td>91</td> </tr> <tr> <td>11</td> <td>111</td> </tr> <tr> <td>12</td> <td>133</td> </tr> </tbody> </table> <p>Figure 12</p>	Figure Number	1	2	3	4	5	No. of white tiles	1	3	7	13	21	No. of black tiles	3	6	9	12	15	Total	4	9	16	25	36	Fig No	No. of white tiles	5	21	6	31	7	43	8	57	9	73	10	91	11	111	12	133
Figure Number	1	2	3	4	5																																						
No. of white tiles	1	3	7	13	21																																						
No. of black tiles	3	6	9	12	15																																						
Total	4	9	16	25	36																																						
Fig No	No. of white tiles																																										
5	21																																										
6	31																																										
7	43																																										
8	57																																										
9	73																																										
10	91																																										
11	111																																										
12	133																																										

Q9) (a) $1 - \frac{4}{9} - \frac{1}{2} = \frac{18}{18} - \frac{8}{18} - \frac{9}{18} = \frac{1}{18}$
 $\frac{1}{18} \rightarrow 36$ $\frac{9}{18} \rightarrow 36 \times 9 = 324$

(b) $12 \times 30 = 360$
 $360 - 324 = 36$
 $12 - 10 = 2$
 $36 \div 2 = 18$

(c) $12 + 12 = 24$
 $56 \div 14 = 4$
 $2 \times 4 = 8$
 $2.80 \div 8 = 0.35$
 $0.35 \times 12 = 4.2$

www.sgexam.com