



Rosyth School  
Term Assessment 2025 (Term 1)  
**SCIENCE**  
Primary 6

Name: \_\_\_\_\_

Class: Pr 6- \_\_\_\_\_

Register No. \_\_\_\_\_

Total  
Marks:

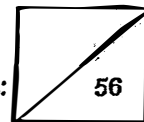

Date: 27 February 2025

Duration: Total time for Booklets A and B: 1 h 45 min

---

## Booklet A

Instructions to Pupils:

1. Please do not turn this page until you are told to do so.
2. Follow all instructions carefully.
3. Answer all questions.
4. This paper consists of 2 booklets, Booklet A and Booklet B.
5. For questions 1 to 28 in Booklet A, shade the correct ovals on the Optical Answer Sheet (OAS) provided using a 2B pencil.

This booklet consists of 20 printed pages (including cover page).

For each question from 1 to 28, four options are given. One of them is the correct answer. Make your choice (1, 2, 3 or 4). Write the correct answer in the OAS provided.

(56 Marks)

1 Casper made the following observations about animal K.

- A It lays eggs.
- B It has four legs.
- C It has moist skin.
- D It lives on land and in water.

Which observations will help Casper to classify animal K as an amphibian?

- (1) A and B only
- (2) C and D only
- (3) A, C and D only
- (4) A, B, C and D

2 Andy placed some fish food into a fish tank. Five seconds later, he observed the fishes swimming towards the fish food.

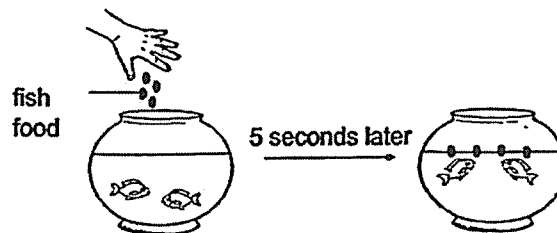

Based on Andy's observation, which characteristic of living things did the fishes show?

- (1) Living things grow.
- (2) Living things reproduce.
- (3) Living things respond to changes.
- (4) Living things need air, food and water to survive.

3 All plants \_\_\_\_\_.

- (1) reproduce by seeds
- (2) make their own food
- (3) bear flowers and fruits
- (4) need oxygen at night only

4 A fruit was cut open as shown below.

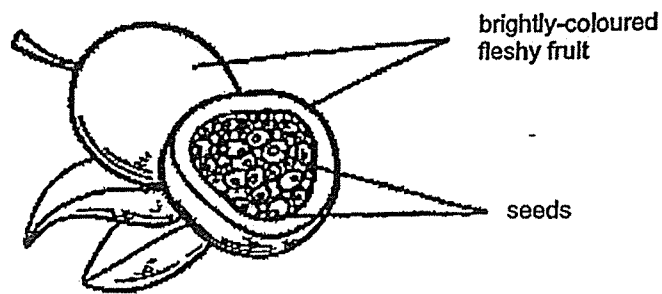

Which of the following statements are correct?

- A There were many ovaries in a flower.
  - B The seeds could be dispersed by animals.
  - C Pollination and fertilisation had taken place.
  - D The fruit and seeds were developed from a flower.
- 
- (1) A and B only
  - (2) A and C only
  - (3) B, C and D only
  - (4) A, B, C and D

5 Study the chart on classification of living things.

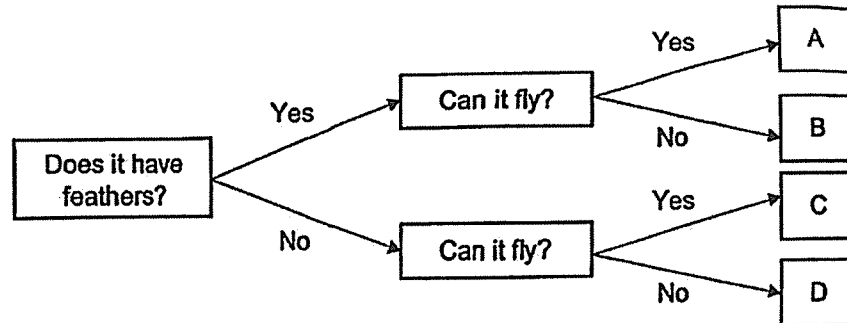

Which of the following is true?

- (1) A is a bat.
- (2) C is a pigeon.
- (3) A and B are birds.
- (4) C and D are insects.

6 Study the three living things shown below.



fern



mushroom

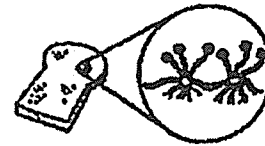

mould

- A They reproduce by spores.
- B They cannot make their own food.
- C They help to decompose dead organisms.

Which statement(s) about the living things is/are correct?

- (1) A only
- (2) C only
- (3) B and C only
- (4) A, B and C

7 Study the stages of development of an animal.

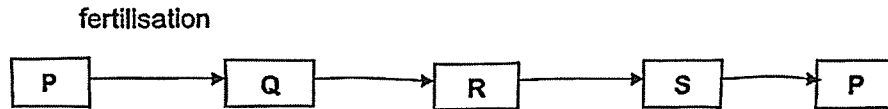

Which of the following correctly shows the animal and stage Q?

|     | Animal    | Q     |
|-----|-----------|-------|
| (1) | cockroach | adult |
| (2) | mosquito  | adult |
| (3) | butterfly | egg   |
| (4) | frog      | egg   |

8 Study the stages of development of insect X as shown below.

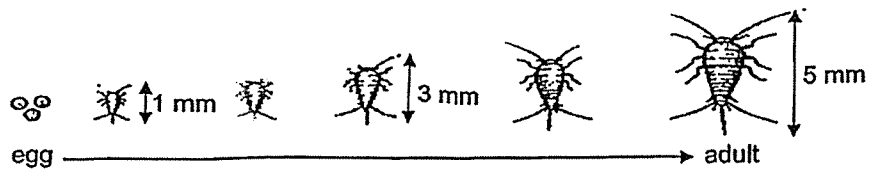

Which of the following animals has a similar life cycle of the insect X?

- (1) beetle
- (2) butterfly
- (3) mosquito
- (4) grasshopper

9 The diagram shows a seedling.



Ahmad observed the seedling for a few days and plotted the graph as shown.

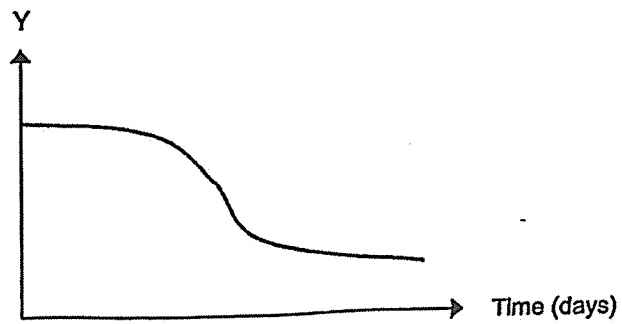

What could the vertical axis, Y, of the graph represent?

- (1) Mass of the seedling
- (2) Height of the seedling
- (3) Mass of the seed leaves
- (4) Length of the roots of the seedling

- 10 Danny wants to measure the volume of a stone.  
Which one of the following apparatus should he use?

(1)



beam balance

(2)



syringe

(3)



electronic balance

(4)



measuring cylinder

- 11 Using an air pump, Jordan added  $15 \text{ cm}^3$  of air into a fully inflated basketball.

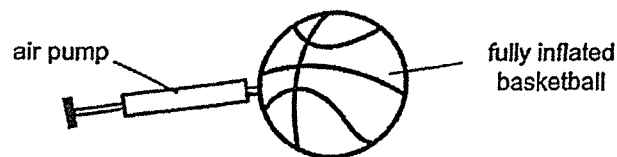

What happens to the total volume and the mass of air in the basketball after  $15 \text{ cm}^3$  of air is added?

|     | Total volume of air in the basketball | Total mass of air in the basketball |
|-----|---------------------------------------|-------------------------------------|
| (1) | increases                             | remains the same                    |
| (2) | increases                             | increases                           |
| (3) | remains the same                      | remains the same                    |
| (4) | remains the same                      | increases                           |

12 Which of the following is/are source(s) of heat?

- A Sun
- B Moon
- C Lighted candle
- D Woollen jacket

- (1) A only
- (2) A and C only
- (3) B and D only
- (4) A, C and D only

13 Michael placed a metal spoon into a beaker of hot water as shown below.

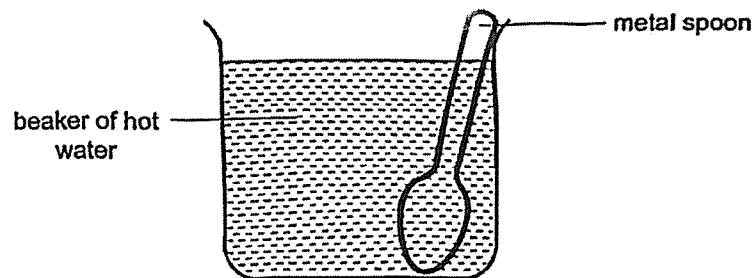

He observed that the spoon became hotter after a while.

Which of the following explains his observation?

- (1) The spoon lost heat to the water.
- (2) The water gained heat from the spoon.
- (3) The spoon gained heat from the water.
- (4) The spoon gained heat from the surrounding air.

14 There is a toy behind an opaque screen.

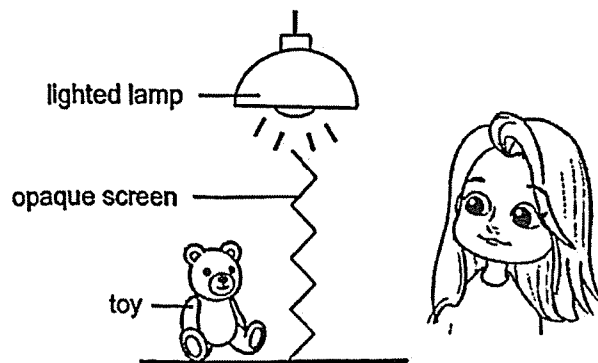

Which statement explains why Nadiah cannot see the toy?

- (1) No light is entering Nadiah's eyes.
- (2) The toy is not reflecting any light.
- (3) Only some light can pass through the screen.
- (4) No light is reflected from the toy into Nadiah's eyes.

15 Johnson listed some sources of energy and their forms of energy. Which one of the following is **not** correct?

|     | Source of energy | Form of energy |
|-----|------------------|----------------|
| (1) | Battery          | Electrical     |
| (2) | Food             | Potential      |
| (3) | Wind             | Kinetic        |
| (4) | Sun              | Heat           |

- 16 Study the set-up below carefully. The pin wheel began to spin soon after the water in the flask boiled.

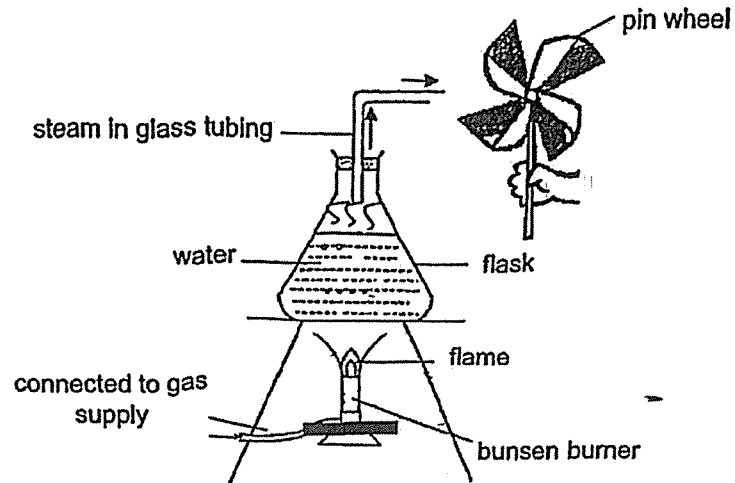

Which one of the following shows correctly the energy conversion which causes the pin wheel to spin?

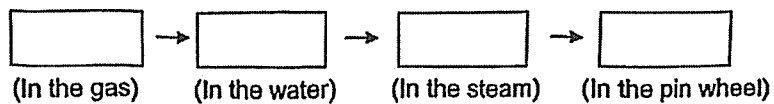

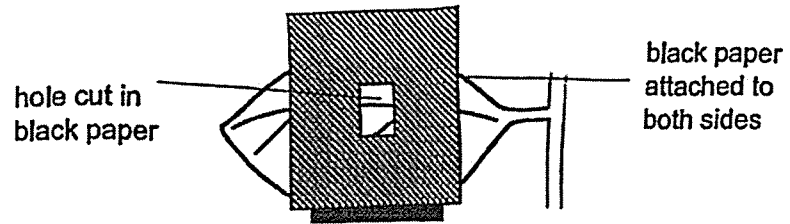

- (1) heat energy → potential energy → heat energy → kinetic energy
- (2) light energy → kinetic energy → kinetic energy → kinetic energy
- (3) potential energy → light energy → kinetic energy → kinetic energy
- (4) potential energy → heat energy → kinetic energy → kinetic energy

- 17 Regina conducted an experiment using a leaf from a plant. She covered part of the leaf with black paper as shown below.



She placed the plant under the sun for three hours and tested for the presence of starch using iodine solution.

Which diagram shows the result of the experiment correctly?

Key:  iodine turned blue-black in the presence of starch  iodine remained yellow when starch is not present

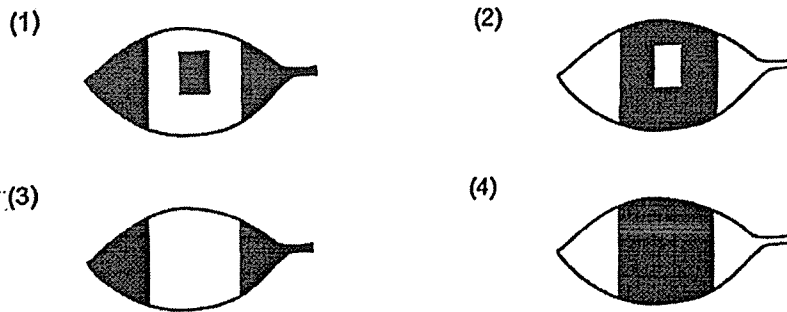

- 18 A ball was released at point E. It rolled along the set-up as shown below and came to rest at point H after hitting a block.

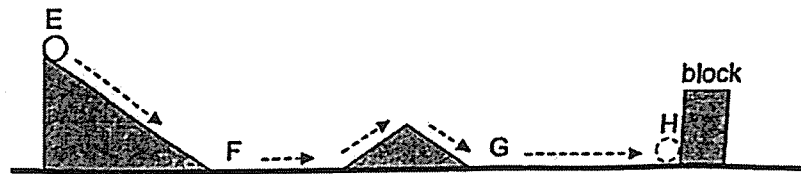

Which of the following statements are correct?

- A The ball had more kinetic energy at F than at G.
  - B The ball had more potential energy at F than at H.
  - C All potential energy was converted to only kinetic energy from E to F.
  - D Some energy was converted to sound energy when the ball hit the block.
- (1) A and D only  
(2) A and B only  
(3) B and C only  
(4) C and D only

19 Study the diagram below.

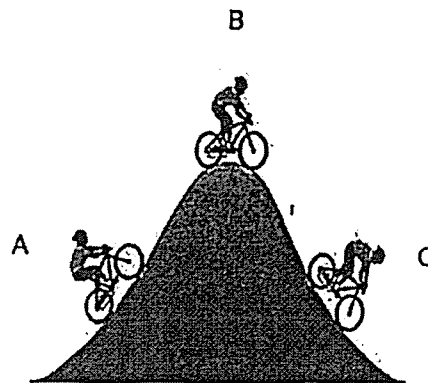

Energy conversion takes place as the cyclist moves from A to C. He stops at B for a minute before coming down.

Which one of the following shows the main form(s) of energy possessed by the cyclist as he moved from A to C respectively?

|     | A                   | B                   | C                   |
|-----|---------------------|---------------------|---------------------|
| (1) | Kinetic + Potential | Potential only      | Kinetic + Potential |
| (2) | Kinetic + Potential | Potential only      | Kinetic only        |
| (3) | Kinetic + Heat      | Potential + Kinetic | Kinetic + Heat      |
| (4) | Kinetic only        | Potential only      | Kinetic + Potential |

- 20 The diagram below shows a wind chime consisting of a star-shaped plate, four identical rods, and a wind catcher. The wind chime is suspended from the ceiling. All parts of the wind chime have the same mass and are made of metal.

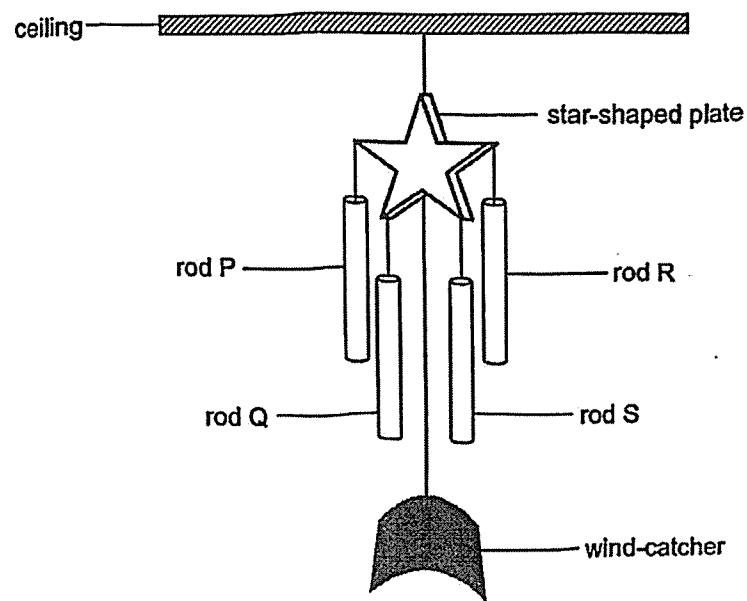

Which of the following statements are correct?

- A The star-shaped plate has the most potential energy.
  - B The wind-catcher has more potential energy than rod P.
  - C Rods Q and S have the same amount of potential energy.
  - D The amount of gravitational force acting on rods R and S is the same.
- (1) A and D only
- (2) B and C only
- (3) A, B and C only
- (4) A, C and D only

- 21 Three balls, X, Y and Z, were dropped from different heights above the sand as shown below.

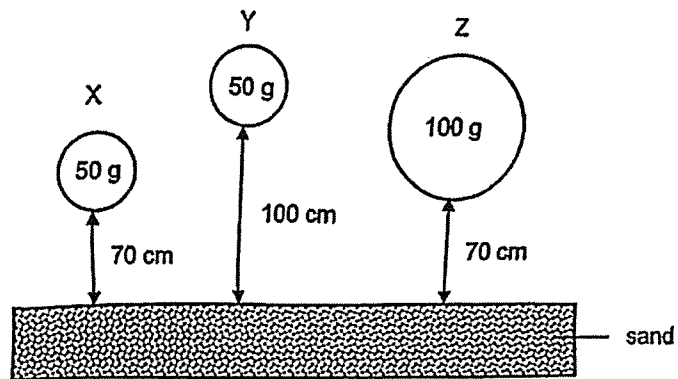

Which of the following statements about the three balls are false?

- A Y has less gravitational potential energy than X.
  - B Z has more gravitational potential energy than X.
  - C X, Y and Z have the same kinetic energy just before they reach the sand.
  - D X has the least kinetic energy among the three balls just before reaching the sand.
- (1) A and B only  
(2) A and C only  
(3) B and D only  
(4) B, C and D only

- 22 The diagram below shows a phone holder for a car. Material X is pasted on the phone cover. The phone with the cover is then safely secured on the phone holder in the car.

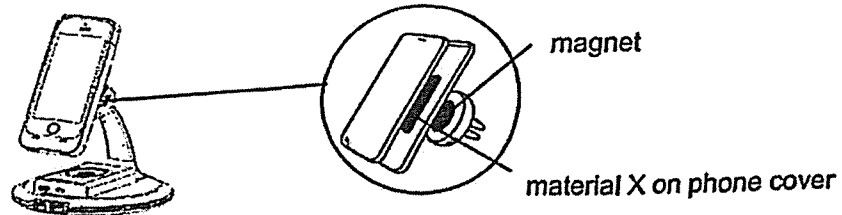

Which of the following statement is definitely correct?

- (1) Material X must be a magnet.
  - (2) Material X cannot be a magnet.
  - (3) Material X is made of a magnetic material.
  - (4) Material X is made of non-magnetic material.
- 23 Gerald kicked a ball as shown in the diagram below.

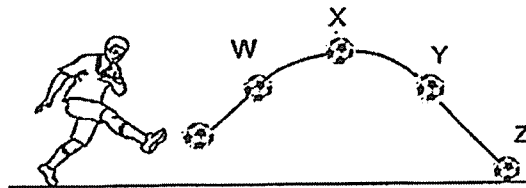

Which of the following statements describes the gravitational force acting on the ball correctly?

Gravitational force \_\_\_\_\_.

- (1) acts on the ball only at X
- (2) acts on the ball at W, X, Y and Z
- (3) acting on the ball at X is more than that at W
- (4) acting on the ball at W helps it to move upwards

- 24 Zaki carried out an experiment with three different bars, X, Y and Z. The ends of the bars are labelled as shown.

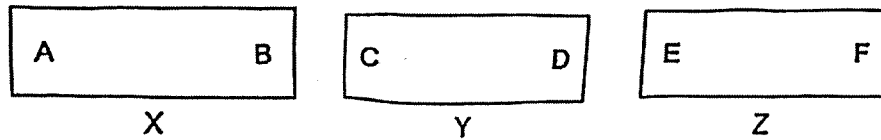

The table below shows how the bars interact when different ends of the bars are brought close to each other.

|   |                      |                      |         |
|---|----------------------|----------------------|---------|
| <table border="1" style="width: 100%;"> <tr> <td style="width: 50%; text-align: center;">A                  B</td> <td style="width: 50%; text-align: center;">C                  D</td> </tr> </table> | A                  B | C                  D | Repel   |
| A                  B  | C                  D |                      |         |
| <table border="1" style="width: 100%;"> <tr> <td style="width: 50%; text-align: center;">A                  B</td> <td style="width: 50%; text-align: center;">D                  C</td> </tr> </table> | A                  B | D                  C | Attract |
| A                  B  | D                  C |                      |         |
| <table border="1" style="width: 100%;"> <tr> <td style="width: 50%; text-align: center;">A                  B</td> <td style="width: 50%; text-align: center;">E                  F</td> </tr> </table> | A                  B | E                  F | Attract |
| A                  B  | E                  F |                      |         |
| <table border="1" style="width: 100%;"> <tr> <td style="width: 50%; text-align: center;">A                  B</td> <td style="width: 50%; text-align: center;">F                  E</td> </tr> </table> | A                  B | F                  E | Attract |
| A                  B  | F                  E |                      |         |

Based on the results given above, which of the following is definitely true?

- (1) Only Y is a magnet.
- (2) X and Y are magnets.
- (3) Z is made of aluminium.
- (4) X and Z are not magnets.

- 25 Stacie throws a ball downwards to hit on the net. Then the ball bounces up after it has hit the net.

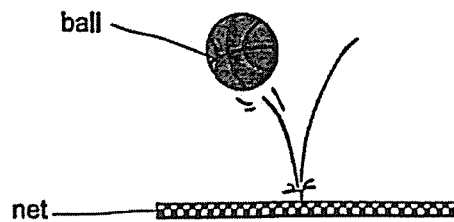

What force causes the ball to bounce up after hitting the net?

- (1) pulling force from the net
  - (2) pulling force from the ball
  - (3) pushing force from the net
  - (4) pushing force from the ball
- 26 Which of the following does not show an effect of force?
- (1) melting a piece of ice cube
  - (2) kicking a slow moving ball
  - (3) stopping a rolling ball
  - (4) flattening a dough

27 Diagram 1 below shows two boats heading towards each other. The boats collided and diagram 2 shows the two boats after the collision.

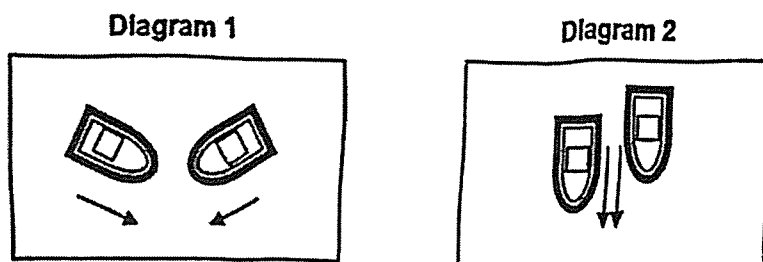

Which of the following statement(s) is/are correct?

The force of collision caused \_\_\_\_\_.

- A both boats to stop moving
  - B both boats to start moving
  - C a change in the shape of the boats
  - D a change in the direction of movement of the boats
- (1) A only  
(2) D only  
(3) B and C only  
(4) C and D only

28 Ray parked his car on a slope as shown.

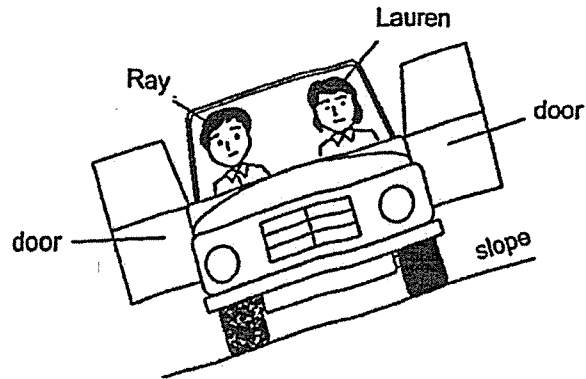

Ray and Lauren opened the door from different sides. Both doors have the same mass. Which of the following is correct?

|     | Force to open door                          | Explanation  |
|-----|---|--|
| (1) | Both Ray and Lauren can use an equal force. | Gravitational force acting on each door is the same. |
| (2) | Lauren has to use more force.               | Force is not exerted against gravitational force.    |
| (3) | Ray can use less force.                     | Force is exerted against gravitational force.        |
| (4) | Ray can use less force.                     | Force is not exerted against gravitational force.    |

Go to Booklet B



**Rosyth School**  
**Term Assessment 2025 (Term 1)**  
**SCIENCE**  
**Primary 6**

Total Marks: 

|    |
|----|
| 44 |
|----|

Name: \_\_\_\_\_

Class: Pr 6- \_

Register No. \_ \_

Date: 27 February 2025

Parent's Signature: \_\_\_\_\_

Duration: Total time for Booklets A and B: 1 h 45 min

---

## Booklet B

Instructions to Pupils:

1. Please do not turn this page until you are told to do so.
2. Follow all instructions carefully.
3. Answer all questions.
4. Use a dark blue or black ballpoint pen to write your answers in the space provided for each question.
5. Do not use correction fluid/tape or highlighters.

|                  | Maximum          | Marks Obtained |
|------------------|------------------|----------------|
| <b>Booklet A</b> | <b>56 marks</b>  |                |
| <b>Booklet B</b> | <b>44 marks</b>  |                |
| <b>Total</b>     | <b>100 marks</b> |                |

\* This booklet consists of 15 printed pages (including cover page).

For questions 29 to 40, write your answers in the space provided. (44 Marks)

29 Study the below classification chart of four living things, C, D, E and F.

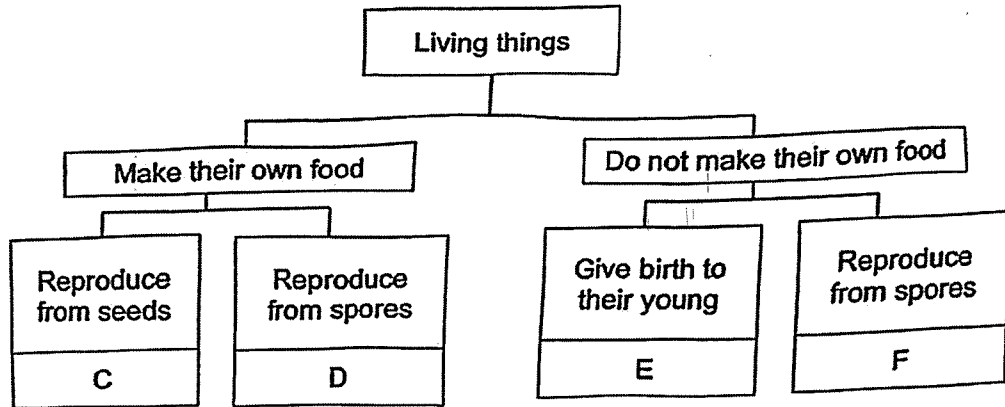

(a) The picture below shows a living thing.



Which letter, C, D, E or F best represents it? Explain your answer. [1]

---

---

(b) State a similar physical characteristic between C and D. [1]

---

---

30

Shun Ying saw a snail in the garden. When she touched the snail, it went into its shell.

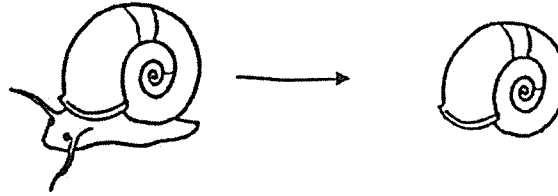

(a) Which characteristic of living things did the snail show? [1]

---

She placed the snail into a sealed tank as shown below.

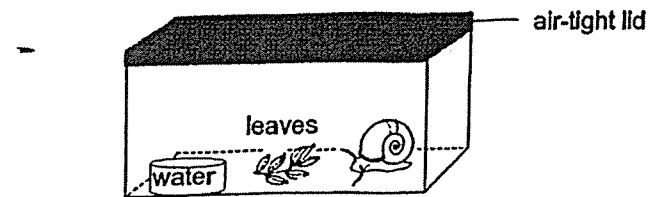

She recorded the number of the leaves in the tank over 5 days as shown in the table below.

| Day | Number of leaves |
|-----|------------------|
| 1   | 10               |
| 2   | 8                |
| 3   | 7                |
| 4   | 7                |
| 5   | 7                |

(b) From Day 1 to 3, what characteristic of living things does the table show? [1]

---



---

(c) What happened to the snail after Day 3? Explain your answer. [2]

---



---

31 The diagrams show the life cycles of two animals, A and B, living in a pond.

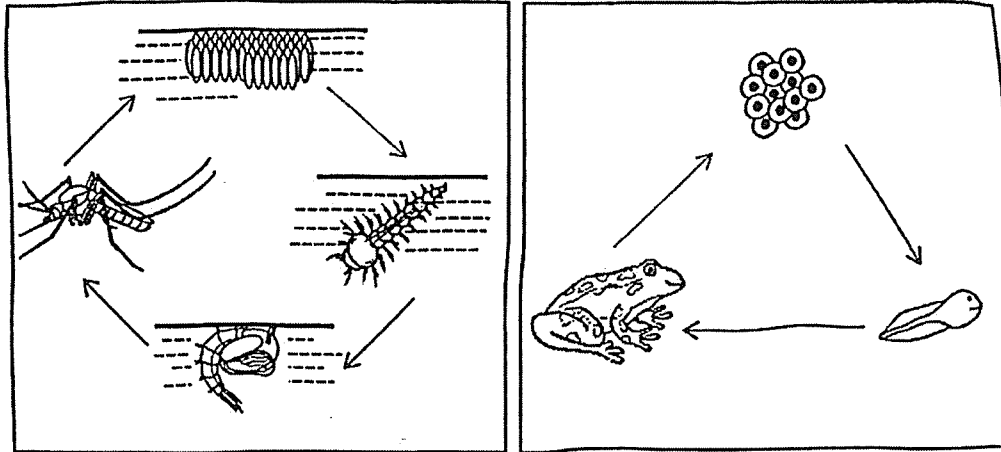

Animal A

Animal B

(a) State a difference between the two life cycles. [1]

---



---

(b) Why do animals A and B lay many eggs at a time? [1]

---



---

The young of animal B lives in water but the adult lives on land.

(c) Suggest two advantages for the young and adult to live in different surroundings? [2]

Advantage 1: \_\_\_\_\_  
 \_\_\_\_\_

Advantage 2: \_\_\_\_\_  
 \_\_\_\_\_

- 32 Rick planted tomato seeds at three different surrounding temperatures. He planted the same number of seeds at each temperature. He recorded the number of seeds that had germinated over six days as shown in the table below.

| Temperature of surroundings (°C) | Total number of tomato seeds germinated |       |       |       |       |       |
|----------------------------------|---|-------|-------|-------|-------|-------|
|                                  | Day 1                                   | Day 2 | Day 3 | Day 4 | Day 5 | Day 6 |
| 5                                | 0                                       | 0     | 0     | 0     | 1     | 1     |
| 15                               | 0                                       | 0     | 0     | 1     | 5     | 9     |
| 25                               | 0                                       | 2     | 8     | 13    | 17    | 19    |

- (a) What was the aim of the experiment? [1]

---



---

- (b) State another variable that has to be kept constant. [1]

---

- (c) What must Rick observe to know that a seed has germinated? [1]

---

- (d) Based on Rick's experimental results, he then made the conclusions listed below.

Tick (✓) the correct box, 'True', 'False' or 'Not Possible to Tell', for each conclusion. [1]

| Conclusion                                 | True | False | Not Possible to Tell |
|--|------|-------|----------------------|
| At 25°C, all seeds germinated by day 6.    |      |       |                      |
| 5°C is too cold for any seed to germinate. |      |       |                      |

- 33 Kyla studied the life cycle of insect X which has four stages. The length of the insect at different stages of its life cycle was recorded in the graph below.

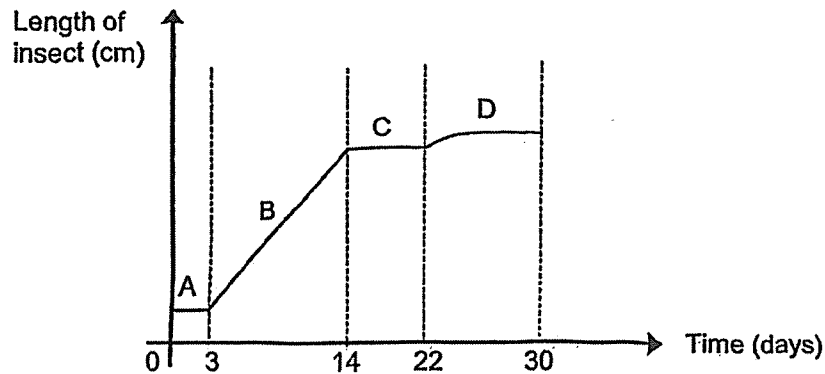

- (a) Identify stages A and C in the life cycle of insect X. [1]

Stage A: \_\_\_\_\_

Stage C: \_\_\_\_\_

- (b) Based on the graph, how many days does it take for insect X to become an adult after the egg is laid? [1]

\_\_\_\_\_

Insect X lays its eggs in water. At different temperatures, the number of eggs laid in water by insect X changes as shown in the table below.

| Temperature of water (°C) | Number of eggs laid |
|---------------------------|---------------------|
| 21                        | 100                 |
| 24                        | 150                 |
| 28                        | 170                 |

Adult X spreads a disease among humans.

- (c) Explain how an increase in the temperature of water affects the number of humans affected by the disease. [1]

\_\_\_\_\_

\_\_\_\_\_

- 34 Objects X, Y and Z are of the same size but made of different materials. Paul wanted to test a physical property of the materials. He poured 200 ml of water onto material X. After five minutes, he measured the volume of water collected in the beaker below. He repeated the experiment for Y and Z.

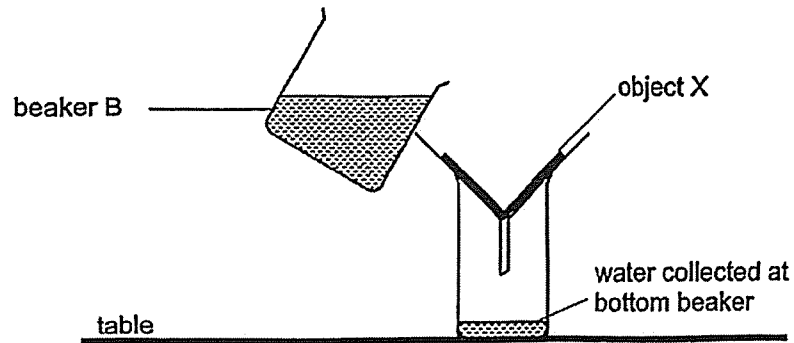

The volume of water collected for each object was recorded.

| Object  | X   | Y   | Z |
|---|-----|-----|---|
| Volume of water collected at bottom beaker (ml) | 180 | 150 | 0 |

- (a) Circle the physical property that Paul was testing. [1]  
 ( strength / flexibility / transparency / waterproof )
- (b) State another variable of the material that has to be kept constant for the experiment to be a fair one. [1]



life jacket  
 (To keep a person's head above water)

- (c) Which material, X, Y, or Z, is the most suitable to make a life jacket? Explain your answer. [2]

- 35 Sue made a jumping toy by taping two pieces of plastic cards together and tying a rubber band around them as shown in the diagram below.

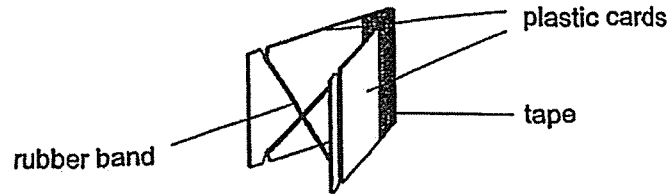

When the plastic cards are opened and pressed down, the rubber band is stretched. When the toy is released, it will jump upwards.

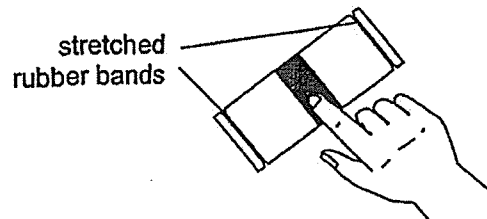

Sue wanted to find out how the number of rubber bands used to make the toy affects the height it jumped to. She increased the number of rubber bands used and recorded the height that the toy reached in the table below.

|                                |   |    |    |    |
|--------------------------------|---|----|----|----|
| Number of rubber bands used    | 1 | 2  | 3  | 4  |
| Height reached by the toy (cm) | 7 | 12 | 18 | 23 |

- (a) Based on the results above, state the relationship between the number of rubber bands used and the height reached by the toy. [1]

---



---

- (b) Using energy conversion, explain your answer in (a). [2]

---



---



---

- 36 Cameron performed an experiment on two different springs, X and Y, of the same length using the set-up shown in the diagram below.

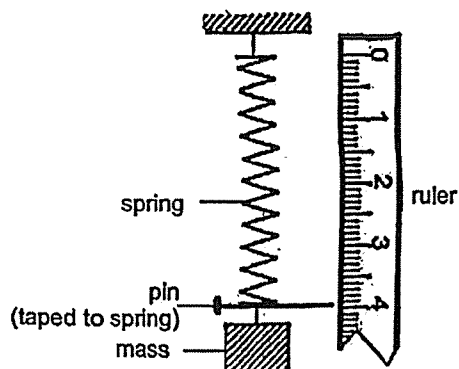

He measured the extension of the spring after adding a 100 g mass each time. His results are shown in the table below.

| Mass (g) | Spring X extension (cm) | Spring Y extension (cm) |
|----------|-------------------------|-------------------------|
| 100      | 3.2                     | 2.2                     |
| 200      | 6.4                     | 2.4                     |
| 300      | 9.3                     | 3.3                     |

- (a) Based on his results, compare the extension of spring X and spring Y when the same amount of mass is added. [1]

Question 36 continues on page 10

Cameron used spring X to make a toy car as shown below. The back wheel was turned back such that it stretched the spring to 6 cm.

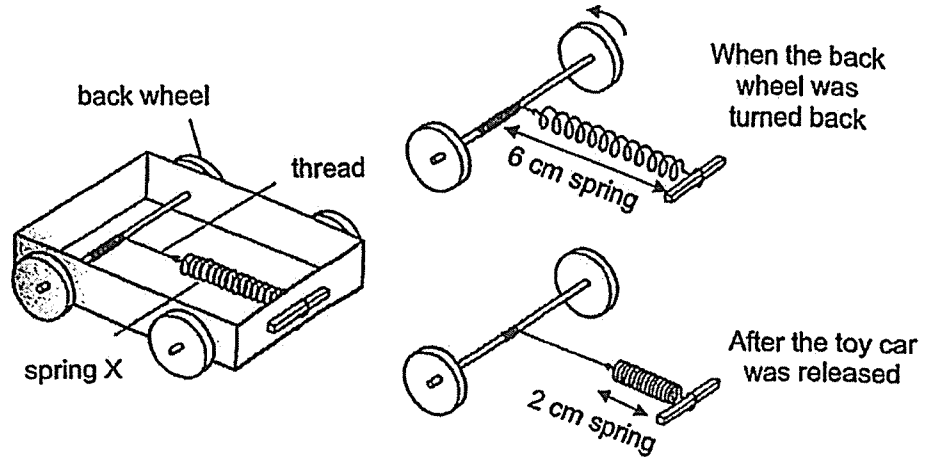

Cameron released the toy car and let it move along a horizontal tabletop.

- (b) Explain, using energy conversion, how this toy car was able to move along the tabletop. [1]

---



---

- (c) Cameron noticed that the toy car slowed down as it moved along the tabletop. Explain your answer in terms of energy conversion. [1]

---



---

Next, Cameron changed spring X to spring Y. He turned the back wheels such that spring Y is stretched to 6 cm.

- (d) Based on the results in Table 1, will the toy car with spring Y move a shorter, longer or equal distance as the toy car with spring X? Explain your answer. [1]

---



---

- 37 The diagram below shows a machine that is used to demolish buildings. The metal ball swings and hits the building to knock it down. The higher the ball swings, the greater the damage done.

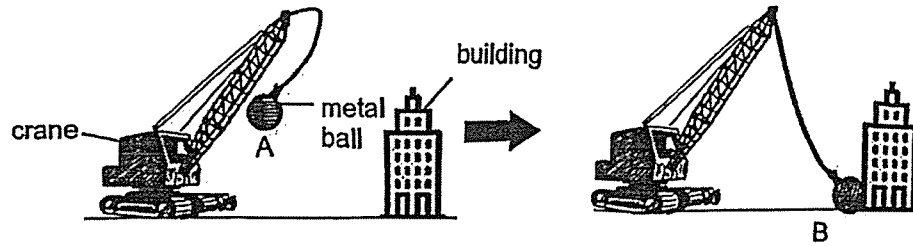

The metal ball is swung backwards before it is released to demolish the building.

- (a) Fill in the boxes below to show the energy conversion as the metal ball is swung from position A to B. [2]

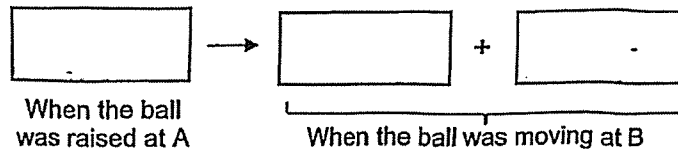

- (b) Explain in terms of energy conversion, how swinging the ball higher will cause more damage to the building. [2]

---



---



---

- (c) Other than swinging the metal ball higher, what change can be made to the ball to make it move faster at B? [1]

---

- 38 The Maglev train is a special train that floats a few centimetres above the track while it is moving. This is made possible by the use of very strong magnets.

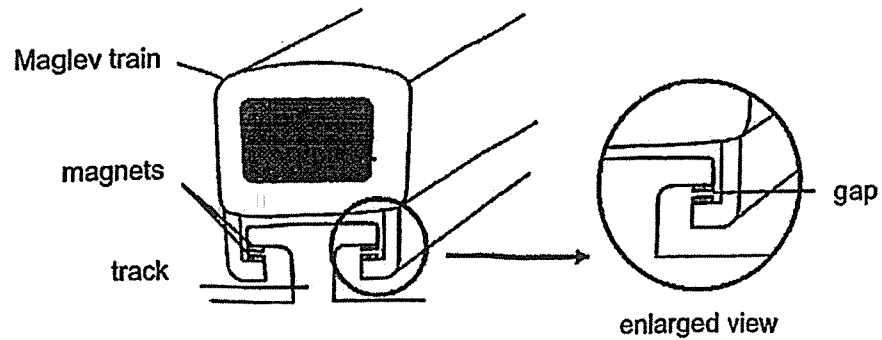

- (a) Explain what causes the gap between the magnets. [1]

---

---

In emergency cases of power loss, the train will stop moving and rest on the train tracks.

- (b) Based on the physical properties of materials, explain why steel is suitable for making the train tracks. [1]

---

---

Question 38 continues on page 13

The Maglev train cannot hold beyond a certain amount of weight for it to function. Sasha made a model of a Maglev train as shown below.

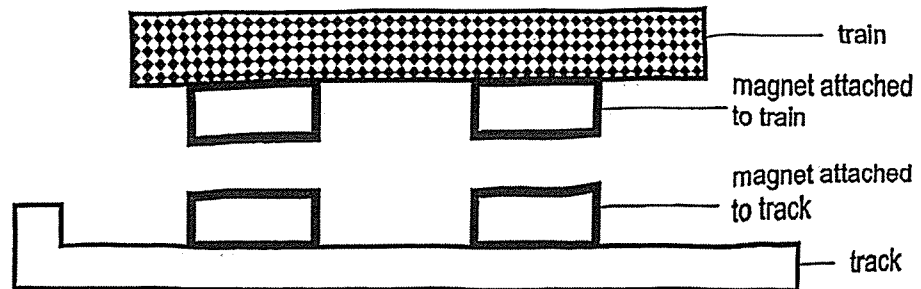

Model of Maglev train

She added 1 kg weights onto her model one at a time and measured the gap between the magnets. She recorded her results in the table below.

|  |     |   |     |   |   |
|--|-----|---|-----|---|---|
| <b>No. of 1 kg weights</b>               | 1   | 2 | 3   | 4 | 5 |
| <b>Distance between the magnets (cm)</b> | 5.5 | 4 | 2.5 | 1 | 0 |

- (c) Based on the results above, what is the greatest mass that can be placed on the train model for it to work? [1]

---

- (d) Suggest how Sasha can find the maximum mass that can be placed on the model more accurately. [1]

---

- 39 Oliver set up an experiment as shown below using four rods with similar lengths but made of different materials, J, K, L and M. He placed some wax at the end of each rod and recorded the time taken for each drop of wax to melt.

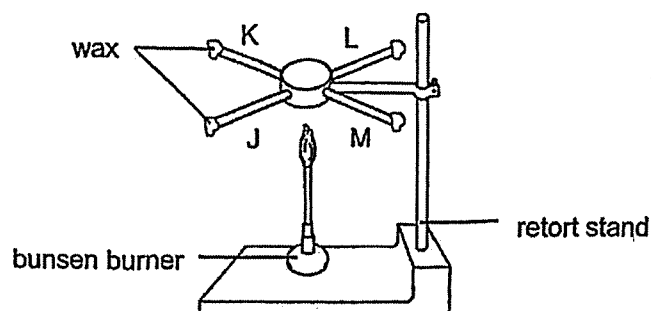

The table below shows the amount of time taken for the wax to melt.

| Material | Time taken for the wax to melt (min) |
|----------|--------------------------------------|
| J        | 9                                    |
| K        | 3                                    |
| L        | 7                                    |
| M        | 2                                    |

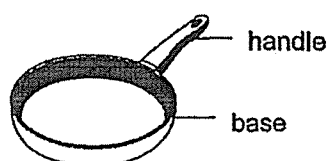

- (a) Based on the experimental results, which material, J, K, L or M is most suitable for making the base of a frying pan. [2]
- \_\_\_\_\_
- \_\_\_\_\_
- (b) How will the time taken for the drops of wax to melt be affected if Oliver lowers the height of the rods? Give a reason for your answer. [1]
- \_\_\_\_\_
- \_\_\_\_\_

40 Jun Xiang threw a piece of plasticine at a noticeboard as shown in the diagram below.

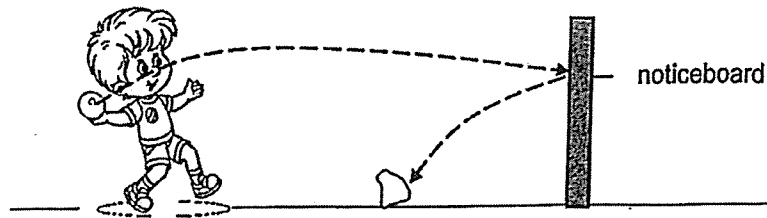

(a) Name the force that caused the plasticine to drop on the ground. [1]

\_\_\_\_\_

(b) State two effects of forces observed by Jun Xiang. [2]

1. \_\_\_\_\_

2. \_\_\_\_\_

Jun Xiang threw a ball of the same mass at the noticeboard with a greater force.

(c) Mark an "A" on the floor in the above diagram to show where the ball might land if Jun Xiang had thrown the ball with a greater force from his starting position. [1]

End of Paper

[www.sgexam.com](http://www.sgexam.com)

**Rosyth P6 Science Term Assessment 2025 (Term 1) Suggested Answers**

**Booklet A**

|     |   |     |   |     |   |
|-----|---|-----|---|-----|---|
| Q1  | 2 | Q11 | 4 | Q21 | 2 |
| Q2  | 3 | Q12 | 2 | Q22 | 3 |
| Q3  | 2 | Q13 | 3 | Q23 | 2 |
| Q4  | 3 | Q14 | 4 | Q24 | 2 |
| Q5  | 3 | Q15 | 1 | Q25 | 3 |
| Q6  | 2 | Q16 | 4 | Q26 | 1 |
| Q7  | 3 | Q17 | 1 | Q27 | 2 |
| Q8  | 4 | Q18 | 1 | Q28 | 4 |
| Q9  | 3 | Q19 | 1 |     |   |
| Q10 | 4 | Q20 | 4 |     |   |

**Booklet B**

| No. | Suggested Answers   |
|-----|---|
| 29a | C. It is a living thing that can make its own food and reproduce from seeds.  |
| 29b | Both C and D have leaves/stem/roots.  |
|     |   |
| 30a | Living things respond to changes.   |
| 30b | Living things need food to survive.   |
| 30c | The snail died. The number of leaves remained unchanged from day 3 to 5. As the sealed tank is covered with air-tight lid, no oxygen can enter, and the snail died due to lack of oxygen. |
|     |   |
| 31a | Animal A has a 4-stage life cycle, but animal B has a 3-stage life cycle.   |
| 31b | This is to ensure that when some eggs are eaten by the predators, there are eggs left that will hatch into young and develop into adults to reproduce.                                    |

|     |   |
|-----|---|
| 31c | <p>Advantage 1: This will reduce the competition for food and space.</p> <p>Advantage 2: When one place is unfavourable, the other place is still available for the young to grow.</p>  |
| 32a | To find out how the temperature of surroundings affects the total number of tomato seeds germinated.  |
| 32b | The volume of water given to each plant.  |
| 32c | He can observe for the presence of roots.   |
| 32d | <p>Not Possible to Tell</p> <p>False</p>  |
| 33a | <p>Stage A: Egg</p> <p>Stage C: Pupa</p>  |
| 33b | 22  |
| 33c | <p>When the temperature of water increases, the number of eggs laid increases. So, more eggs will hatch into more young and develop into more adults to spread more diseases among humans.</p>  |
| 34a | Waterproof  |
| 34b | The thickness of the material.  |
| 34c | Z, the volume of water collected at the bottom beaker is zero. So, the material does not absorb water and is waterproof. So that the life jacket does not absorb any water when being used in water.  |
| 35a | As the number of rubber bands used increases, the height reached by the toy increases.  |
| 35b | As more rubber bands are used, there is more elastic potential energy in the stretched rubber bands converted to more kinetic energy in the moving toy. It is then converted to more gravitational potential energy in the toy, causing the toy to move higher. |
| 36a | Spring Y extends less than X when the same amount of mass is added. Y is stiffer than X.  |
| 36b | When the spring is stretched and extended, it has elastic potential energy converted to kinetic energy  |
| 36c | Some of the kinetic energy has been converted to heat energy and sound energy.  |
| 36d | Longer. Y is stiffer than X. So, when Y stretched in the same length has more elastic potential energy converted to more kinetic energy, allowing the toy car to move further.  |
| 37a | (Gravitational) Potential Energy → Kinetic Energy + Sound/Heat Energy   |

|     |  |
|-----|--|
| 37b | When the ball swings higher, it has more (gravitational) potential energy converted to more kinetic energy, hitting the building with greater impact.                              |
| 37c | Change the ball to another with greater mass.  |
| 38a | The like poles of the magnets are facing each other and repelled. Like poles repel.  |
| 38b | Metal is strong and it will not break when the weight of the train acts on the track.  |
| 38c | 4 kg   |
| 38d | Use lighter weights or use weights less than 1 kg.   |
| 39a | M, the time taken for the wax to melt is the shortest. M is the best conductor of heat. It will gain heat the fastest from the heat source and cook the food in the shortest time. |
| 39b | The time taken for the drops of wax to melt decreases as the distance between the flame and the rods decreases. The wax gained heat faster from the flame.                         |
| 40a | Gravitational force  |
| 40b | The shape of the plasticine changed.<br>The plasticine will move   |
| 40c | Draw and label 'A' between Jun Xiang and the plasticine on the ground.   |

[www.sgexam.com](http://www.sgexam.com)